



Cisco IOS IPv6 Configuration Guide

Release 12.4

Corporate Headquarters

Cisco Systems, Inc.
170 West Tasman Drive
San Jose, CA 95134-1706
USA
<http://www.cisco.com>
Tel: 408 526-4000
800 553-NETS (6387)
Fax: 408 526-4100

Customer Order Number: DOC-7817482=
Text Part Number: 78-17482-01



THE SPECIFICATIONS AND INFORMATION REGARDING THE PRODUCTS IN THIS MANUAL ARE SUBJECT TO CHANGE WITHOUT NOTICE. ALL STATEMENTS, INFORMATION, AND RECOMMENDATIONS IN THIS MANUAL ARE BELIEVED TO BE ACCURATE BUT ARE PRESENTED WITHOUT WARRANTY OF ANY KIND, EXPRESS OR IMPLIED. USERS MUST TAKE FULL RESPONSIBILITY FOR THEIR APPLICATION OF ANY PRODUCTS.

THE SOFTWARE LICENSE AND LIMITED WARRANTY FOR THE ACCOMPANYING PRODUCT ARE SET FORTH IN THE INFORMATION PACKET THAT SHIPPED WITH THE PRODUCT AND ARE INCORPORATED HEREIN BY THIS REFERENCE. IF YOU ARE UNABLE TO LOCATE THE SOFTWARE LICENSE OR LIMITED WARRANTY, CONTACT YOUR CISCO REPRESENTATIVE FOR A COPY.

The Cisco implementation of TCP header compression is an adaptation of a program developed by the University of California, Berkeley (UCB) as part of UCB's public domain version of the UNIX operating system. All rights reserved. Copyright © 1981, Regents of the University of California.

NOTWITHSTANDING ANY OTHER WARRANTY HEREIN, ALL DOCUMENT FILES AND SOFTWARE OF THESE SUPPLIERS ARE PROVIDED "AS IS" WITH ALL FAULTS. CISCO AND THE ABOVE-NAMED SUPPLIERS DISCLAIM ALL WARRANTIES, EXPRESSED OR IMPLIED, INCLUDING, WITHOUT LIMITATION, THOSE OF MERCHANTABILITY, FITNESS FOR A PARTICULAR PURPOSE AND NONINFRINGEMENT OR ARISING FROM A COURSE OF DEALING, USAGE, OR TRADE PRACTICE.

IN NO EVENT SHALL CISCO OR ITS SUPPLIERS BE LIABLE FOR ANY INDIRECT, SPECIAL, CONSEQUENTIAL, OR INCIDENTAL DAMAGES, INCLUDING, WITHOUT LIMITATION, LOST PROFITS OR LOSS OR DAMAGE TO DATA ARISING OUT OF THE USE OR INABILITY TO USE THIS MANUAL, EVEN IF CISCO OR ITS SUPPLIERS HAVE BEEN ADVISED OF THE POSSIBILITY OF SUCH DAMAGES.

CCSP, CCVP, the Cisco Square Bridge logo, Follow Me Browsing, and StackWise are trademarks of Cisco Systems, Inc.; Changing the Way We Work, Live, Play, and Learn, and iQuick Study are service marks of Cisco Systems, Inc.; and Access Registrar, Aironet, BPX, Catalyst, CCDA, CCDP, CCIE, CCIP, CCNA, CCNP, Cisco, the Cisco Certified Internetwork Expert logo, Cisco IOS, Cisco Press, Cisco Systems, Cisco Systems Capital, the Cisco Systems logo, Cisco Unity, Enterprise/Solver, EtherChannel, EtherFast, EtherSwitch, Fast Step, FormShare, GigaDrive, GigaStack, HomeLink, Internet Quotient, IOS, IP/TV, iQ Expertise, the iQ logo, iQ Net Readiness Scorecard, LightStream, Linksys, MeetingPlace, MGX, the Networkers logo, Networking Academy, Network Registrar, *Packet*, PIX, Post-Routing, Pre-Routing, ProConnect, RateMUX, ScriptShare, SlideCast, SMARTnet, The Fastest Way to Increase Your Internet Quotient, and TransPath are registered trademarks of Cisco Systems, Inc. and/or its affiliates in the United States and certain other countries.

All other trademarks mentioned in this document or Website are the property of their respective owners. The use of the word partner does not imply a partnership relationship between Cisco and any other company. (0601R)

Any Internet Protocol (IP) addresses used in this document are not intended to be actual addresses. Any examples, command display output, and figures included in the document are shown for illustrative purposes only. Any use of actual IP addresses in illustrative content is unintentional and coincidental.

Cisco IOS IPv6 Configuration Guide

© 2005–2006 Cisco Systems, Inc. All rights reserved.



About Cisco IOS Software Documentation for Release 12.4 xxvii

Documentation Objectives	xxvii
Audience	xxvii
Documentation Organization for Cisco IOS Release 12.4	xxviii
Document Conventions	xxxiv
Obtaining Documentation	xxxv
Cisco.com	xxxv
Product Documentation DVD	xxxvi
Ordering Documentation	xxxvi
Documentation Feedback	xxxvi
Cisco Product Security Overview	xxxvii
Reporting Security Problems in Cisco Products	xxxvii
Obtaining Technical Assistance	xxxviii
Cisco Technical Support & Documentation Website	xxxviii
Submitting a Service Request	xxxviii
Definitions of Service Request Severity	xxxix
Obtaining Additional Publications and Information	xxxix

Using Cisco IOS Software for Release 12.4 xli

Understanding Command Modes	xli
Getting Help	xlii
Example: How to Find Command Options	xliii
Using the no and default Forms of Commands	xlvi
Saving Configuration Changes	xlvi
Filtering Output from the show and more Commands	xlvii
Finding Additional Feature Support Information	xlvii

Start Here: Cisco IOS Software Release Specifics for IPv6 Features 1

Cisco IOS Software Platform Dependencies and Restrictions	1
Cisco IOS IPv6 Features and Supported Software Releases	2
Cisco Platforms Supporting IPv6 Hardware Forwarding	11
Supported Platforms	11
Additional 12.2S Release Trains	12
Supported RFCs	13

MIBs	15
Related Documents	15
Implementing IPv6 Addressing and Basic Connectivity	17
Contents	17
Prerequisites for Implementing IPv6 Addressing and Basic Connectivity	18
Restrictions for Implementing IPv6 Addressing and Basic Connectivity	18
Information About Implementing IPv6 Addressing and Basic Connectivity	19
IPv6 for Cisco IOS Software	19
Large IPv6 Address Space for Unique Addresses	20
IPv6 Address Formats	20
IPv6 Address Type: Unicast	21
Aggregatable Global Address	22
Site-Local Address	23
Link-Local Address	24
IPv4-Compatible IPv6 Address	24
IPv6 Address Type: Anycast	24
IPv6 Address Type: Multicast	25
IPv6 Address Output Display	27
Simplified IPv6 Packet Header	27
Cisco Express Forwarding and distributed Cisco Express Forwarding Switching for IPv6	31
Unicast Reverse Path Forwarding	32
DNS for IPv6	33
Path MTU Discovery for IPv6	33
Cisco Discovery Protocol IPv6 Address Support	34
ICMP for IPv6	34
IPv6 Neighbor Discovery	34
IPv6 Neighbor Solicitation Message	35
IPv6 Router Advertisement Message	36
IPv6 Neighbor Redirect Message	38
HSRP for IPv6	40
Link, Subnet, and Site Addressing Changes	40
IPv6 Stateless Autoconfiguration	40
Simplified Network Renumbering for IPv6 Hosts	41
IPv6 General Prefixes	42
DHCP for IPv6 Prefix Delegation	42
IPv6 Prefix Aggregation	42
IPv6 Site Multihoming	43
IPv6 Data Links	43
Routed Bridge Encapsulation for IPv6	44

Dual IPv4 and IPv6 Protocol Stacks	44
How to Implement IPv6 Addressing and Basic Connectivity	45
Configuring IPv6 Addressing and Enabling IPv6 Routing	45
IPv6 Multicast Groups	46
Restrictions	46
Enabling an HSRP Group for IPv6 Operation	48
Defining and Using IPv6 General Prefixes	50
Defining a General Prefix Manually	51
Defining a General Prefix Based on a 6to4 Interface	51
Defining a General Prefix with the DHCP for IPv6 Prefix Delegation Client Function	52
Using a General Prefix in IPv6	52
Configuring an Interface to Support the IPv4 and IPv6 Protocol Stacks	53
Configuring Syslog over IPv6	54
Configuring IPv6 ICMP Rate Limiting	55
IPv6 ICMP Rate Limiting	55
Configuring the DRP Extension for Traffic Engineering	56
Configuring Cisco Express Forwarding and distributed Cisco Express Forwarding Switching for IPv6	57
Configuring Cisco Express Forwarding Switching on Distributed and Nondistributed Architecture Platforms	57
Prerequisites	57
Restrictions	58
Configuring Unicast RPF	60
Mapping Hostnames to IPv6 Addresses	61
Hostname-to-Address Mappings	61
Mapping IPv6 Addresses to IPv6 ATM and Frame Relay Interfaces	63
IPv6 for Cisco IOS Software Support for Wide-Area Networking Technologies	63
IPv6 Addresses and PVCs	63
Displaying IPv6 Redirect Messages	66
IPv6 Redirect Messages	66
Examples	68
Configuration Examples for Implementing IPv6 Addressing and Basic Connectivity	72
IPv6 Addressing and IPv6 Routing Configuration: Example	73
Dual Protocol Stacks Configuration: Example	74
IPv6 ICMP Rate Limiting Configuration: Example	74
Cisco Express Forwarding and distributed Cisco Express Forwarding Configuration: Example	74
Hostname-to-Address Mappings Configuration: Example	75
IPv6 Address to ATM and Frame Relay PVC Mapping Configuration: Examples	75
IPv6 ATM PVC Mapping Configuration—Point-to-Point Interface: Example	75
IPv6 ATM PVC Mapping Configuration—Point-to-Multipoint Interface: Example	76

IPv6 Frame Relay PVC Mapping Configuration—Point-to-Point Interface: Example	76
IPv6 Frame Relay PVC Mapping Configuration—Point-to-Multipoint Interface: Example	77
Where to Go Next	78
Additional References	78
Related Documents	78
Standards	79
MIBs	79
RFCs	79
Technical Assistance	80
Feature Information for Implementing IPv6 Addressing and Basic Connectivity	81
Implementing ADSL and Deploying Dial Access for IPv6	89
Contents	89
Prerequisites for Implementing ADSL and Dial Access for IPv6	89
Restrictions for Implementing ADSL and Deploying Dial Access for IPv6	90
Information About Implementing ADSL and Deploying Dial Access for IPv6	90
Address Assignment for IPv6	90
Stateless Address Autoconfiguration	91
Prefix Delegation	91
AAA Attributes for IPv6	91
Prerequisites for Using AAA Attributes for IPv6	92
RADIUS Per-User Attributes for Virtual Access in IPv6 Environments	92
IPv6 Prefix Pools	94
How to Configure ADSL and Deploy Dial Access in IPv6	94
Configuring the NAS	94
Troubleshooting Tips	97
What to Do Next	97
Configuring the Remote CE Router	97
What to Do Next	99
Configuring the DHCP for IPv6 Server to Obtain Prefixes from RADIUS Servers	100
Prerequisites	100
Configuring DHCP for IPv6 AAA and SIP Options	101
Configuration Examples for Implementing ADSL and Deploying Dial Access for IPv6	102
Implementing ADSL and Deploying Dial Access for IPv6 Example	102
Where to Go Next	103
Additional References	103
Related Documents	103
Standards	104
MIBs	104

RFCs	104
Technical Assistance	104
Implementing Multiprotocol BGP for IPv6	105
Contents	105
Prerequisites for Implementing Multiprotocol BGP for IPv6	105
Information About Implementing Multiprotocol BGP for IPv6	106
Multiprotocol BGP Extensions for IPv6	106
Multiprotocol BGP for the IPv6 Multicast Address Family	107
6PE Multipath	107
How to Implement Multiprotocol BGP for IPv6	107
Configuring an IPv6 BGP Routing Process and BGP Router ID	108
Prerequisites	108
BGP Router ID for IPv6	108
Configuring an IPv6 Multiprotocol BGP Peer	109
Restrictions	109
Configuring an IPv6 Multiprotocol BGP Peer Using a Link-Local Address	111
Multiprotocol BGP Peering Using Link-Local Addresses	111
Restrictions	111
Troubleshooting Tips	114
Configuring an IPv6 Multiprotocol BGP Peer Group	114
Restrictions	115
What to Do Next	117
Advertising Routes into IPv6 Multiprotocol BGP	117
Restrictions	117
Configuring a Route Map for IPv6 Multiprotocol BGP Prefixes	118
Restrictions	118
Redistributing Prefixes into IPv6 Multiprotocol BGP	120
Redistribution for IPv6	121
Advertising IPv4 Routes Between IPv6 BGP Peers	122
Assigning a BGP Administrative Distance	124
Generating Translate Updates for IPv6 Multicast BGP	125
Resetting BGP Sessions	127
Clearing External BGP Peers	127
Clearing IPv6 BGP Route Dampening Information	128
Clearing IPv6 BGP Flap Statistics	129
Verifying IPv6 Multiprotocol BGP Configuration and Operation	129
Output Examples	130
Sample Output for the show bgp ipv6 Command	131
Sample Output for the show bgp ipv6 summary Command	131

Sample Output for the show bgp ipv6 dampened-paths Command	131
Sample Output for the debug bgp ipv6 dampening Command	132
Sample Output for the debug bgp ipv6 updates Command	132
Configuration Examples for Multiprotocol BGP for IPv6	133
Configuring a BGP Process, BGP Router ID, and IPv6 Multiprotocol BGP Peer Example	133
Configuring an IPv6 Multiprotocol BGP Peer Using a Link-Local Address Example	133
Configuring an IPv6 Multiprotocol BGP Peer Group Example	134
Advertising Routes into IPv6 Multiprotocol BGP Example	134
Configuring a Route Map for IPv6 Multiprotocol BGP Prefixes Example	134
Redistributing Prefixes into IPv6 Multiprotocol BGP Example	135
Advertising IPv4 Routes Between IPv6 Peers Example	135
Where to Go Next	135
Additional References	136
Related Documents	136
Standards	136
MIBs	136
RFCs	136
Technical Assistance	137
Implementing DHCP for IPv6	139
Contents	139
Prerequisites for Implementing DHCP for IPv6	139
Restrictions for Implementing DHCP for IPv6	140
Information About Implementing DHCP for IPv6	140
DHCP for IPv6 Prefix Delegation	140
Configuring Nodes Without Prefix Delegation	140
Client and Server Identification	140
Rapid Commit	141
DHCP for IPv6 Client, Server, and Relay Functions	141
Client Function	141
Server Function	141
DHCP Relay Agent	143
How to Implement DHCP for IPv6	144
Configuring the DHCP for IPv6 Server Function	144
Configuring the DHCP for IPv6 Client Function	145
Configuring the DHCP for IPv6 Relay Agent	146
Configuring a Database Agent for the Server Function	147
Configuring the Stateless DHCP for IPv6 Function	148
Defining a General Prefix with the DHCP for IPv6 Prefix Delegation Client Function	151

Restarting the DHCP for IPv6 Client on an Interface	152
Deleting Automatic Client Bindings from the DHCP for IPv6 Binding Table	152
Troubleshooting DHCP for IPv6	153
Verifying DHCP for IPv6 Configuration and Operation	154
Examples	155
Configuration Examples for Implementing DHCP for IPv6	157
Configuring the DHCP for IPv6 Server Function: Example	158
Configuring the DHCP for IPv6 Client Function: Example	158
Configuring a Database Agent for the Server Function: Example	158
Configuring the Stateless DHCP for IPv6 Function: Example	159
Additional References	159
Related Documents	159
Standards	160
MIBs	160
RFCs	160
Technical Assistance	160
Feature Information for Implementing DHCP for IPv6	161
Implementing EIGRP for IPv6	163
Contents	163
Prerequisites for Implementing EIGRP for IPv6	164
Restrictions for Implementing EIGRP for IPv6	164
Information About Implementing EIGRP for IPv6	164
Cisco EIGRP for IPv6 Implementation	164
How to Implement EIGRP for IPv6	166
Enabling EIGRP for IPv6 on an Interface	166
Configuring the Percentage of Link Bandwidth Used	168
Configuring Summary Aggregate Addresses	169
Configuring EIGRP Route Authentication	170
Changing the Next Hop in EIGRP	172
Adjusting the Interval Between Hello Packets in EIGRP for IPv6	173
Adjusting the Hold Time in EIGRP for IPv6	174
Disabling Split Horizon in EIGRP for IPv6	175
Configuring EIGRP Stub Routing for Greater Stability	176
Configuring a Router for EIGRP Stub Routing	176
Verifying EIGRP Stub Routing	177
Customizing an EIGRP for IPv6 Routing Process	178
Logging EIGRP Neighbor Adjacency Changes	178
Configuring Intervals Between Neighbor Warnings	179

- Adjusting the EIGRP for IPv6 Metric Weights 180
- Monitoring and Maintaining EIGRP 181
 - Deleting Entries from EIGRP for IPv6 Routing Tables 181
 - Using Debugging Commands to Troubleshoot an EIGRP for IPv6 Environment 182
- Configuration Examples for Implementing EIGRP for IPv6 183
 - Configuring EIGRP to Establish Adjacencies on an Interface 183
- Where to Go Next 184
- Additional References 184
 - Related Documents 184
 - Standards 184
 - MIBs 184
 - RFCs 185
 - Technical Assistance 185
- Feature Information for Implementing EIGRP for IPv6 186
- Configuring GLBP for IPv6 187**
 - Contents 187
 - Prerequisites for GLBP for IPv6 187
 - Information About GLBP for IPv6 188
 - GLBP Overview 188
 - GLBP Active Virtual Gateway 188
 - GLBP Virtual MAC Address Assignment 189
 - GLBP Virtual Gateway Redundancy 190
 - GLBP Virtual Forwarder Redundancy 190
 - GLBP Gateway Priority 190
 - GLBP Gateway Weighting and Tracking 191
 - GLBP Benefits 191
 - How to Configure GLBP for IPv6 191
 - Customizing GLBP 192
 - Configuring GLBP Authentication 194
 - How GLBP MD5 Authentication Works 194
 - Configuring GLBP MD5 Authentication Using a Key String 195
 - Configuring GLBP MD5 Authentication Using a Key Chain 197
 - Configuring GLBP Text Authentication 200
 - Configuring GLBP Weighting Values and Object Tracking 202
 - Enabling and Verifying GLBP 204
 - Prerequisites 204
 - Examples 206
 - Troubleshooting the Gateway Load Balancing Protocol 206

Prerequisites	207
Configuration Examples for GLBP for IPv6	208
Customizing GLBP Configuration: Example	208
GLBP MD5 Authentication Using Key Strings: Example	208
GLBP MD5 Authentication Using Key Chains: Example	209
GLBP Text Authentication: Example	209
GLBP Weighting: Example	209
Enabling GLBP Configuration: Example	209
Additional References	210
Related Documents	210
Standards	210
MIBs	210
RFCs	210
Technical Assistance	211
Glossary	212
Feature Information for GLBP for IPv6	213
Implementing IPsec in IPv6 Security	215
Contents	215
Prerequisites for Implementing IPsec for IPv6 Security	215
Information About Implementing IPsec for IPv6 Security	216
OSPF for IPv6 Authentication Support with IPsec	216
IPsec for IPv6	216
IPv6 IPsec Site-to-Site Protection Using Virtual Tunnel Interface	217
How to Implement IPsec for IPv6 Security	218
Configuring a VTI for Site-to-Site IPv6 IPsec Protection	218
Creating an IKE Policy and a Preshared Key in IPv6	218
Configuring ISAKMP Aggressive Mode	221
Configuring an IPsec Transform Set and IPsec Profile	222
Configuring an ISAKMP Profile in IPv6	223
Configuring IPv6 IPsec VTI	224
Verifying IPsec Tunnel Mode Configuration	226
Troubleshooting IPsec for IPv6 Configuration and Operation	228
Examples	229
Configuration Examples for IPsec for IPv6 Security	232
Configuring a VTI for Site-to-Site IPv6 IPsec Protection: Example	232
Additional References	233
Related Documents	233
Standards	233

MIBs	233
RFCs	234
Technical Assistance	234
Implementing IS-IS for IPv6	235
Contents	235
Prerequisites for Implementing IS-IS for IPv6	235
Restrictions for Implementing IS-IS for IPv6	236
Information About Implementing IS-IS for IPv6	236
IS-IS Enhancements for IPv6	237
IS-IS Single-Topology Support for IPv6	237
IS-IS Multitopology Support for IPv6	237
Transition from Single-Topology to Multitopology Support for IPv6	237
IPv6 IS-IS Local RIB	238
How to Implement IS-IS for IPv6	238
Configuring Single-Topology IS-IS for IPv6	238
Prerequisites	239
Restrictions	239
Configuring Multitopology IS-IS for IPv6	240
Prerequisites	240
Customizing IPv6 IS-IS	242
Redistributing Routes into an IPv6 IS-IS Routing Process	244
Redistributing IPv6 IS-IS Routes Between IS-IS Levels	245
Disabling IPv6 Protocol-Support Consistency Checks	246
Disabling IPv4 Subnet Consistency Checks	247
Verifying IPv6 IS-IS Configuration and Operation	248
Troubleshooting Tips	249
Examples	250
Sample Output for the show ipv6 protocols Command	250
Sample Output for the show isis topology Command	250
Sample Output for the show clns neighbors Command	251
Sample Output for the show clns is-neighbors Command	251
Sample Output for the show isis database Command	251
Sample Output for the show isis ipv6 rib Command	252
Configuration Examples for IPv6 IS-IS	253
Configuring Single-Topology IS-IS for IPv6 Example	253
Customizing IPv6 IS-IS Example	253
Redistributing Routes into an IPv6 IS-IS Routing Process Example	253
Redistributing IPv6 IS-IS Routes Between IS-IS Levels Example	254

Disabling IPv6 Protocol-Support Consistency Checks Example	254
Configuring Multitopology IS-IS for IPv6 Example	254
Configuring the IS-IS IPv6 Metric for Multitopology IS-IS Example	254
Where to Go Next	254
Additional References	255
Related Documents	255
Standards	255
MIBs	255
RFCs	255
Technical Assistance	256
Managing Cisco IOS Applications over IPv6	257
Contents	257
Prerequisites for Managing Cisco IOS Applications over IPv6	257
Information About Managing Cisco IOS Applications over IPv6	258
Telnet Access over IPv6	258
TFTP File Downloading, ping, and traceroute Commands for IPv6	258
SSH over an IPv6 Transport	259
SNMP over an IPv6 Transport	259
How to Manage Cisco IOS Applications over IPv6	260
Enabling Telnet Access to an IPv6 Router and Establishing a Telnet Session	260
What to Do Next	261
Enabling SSH on an IPv6 Router	262
Prerequisites	262
Restrictions	262
What to Do Next	263
Disabling HTTP Access to an IPv6 Router	264
What to Do Next	264
Configuring an SNMP Notification Server over IPv6	264
What to Do Next	266
Configuration Examples for Managing Cisco IOS Applications over IPv6	266
Enabling Telnet Access to an IPv6 Router Configuration: Examples	267
Disabling HTTP Access to the Router: Example	268
Configuring an SNMP Notification Server: Examples	268
Where to Go Next	269
Additional References	269
Related Documents	269
Standards	270
MIBs	270

RFCs	270
Technical Assistance	270
Implementing Mobile IPv6	271
Contents	271
Prerequisites for Implementing Mobile IPv6	271
Restrictions for Mobile IPv6	272
Information About Mobile IPv6	272
Mobile IPv6 Overview	272
Mobile IPv6 Benefits	272
Mobile IPv6 Home Agent	273
Binding Cache in Mobile IPv6 Home Agent	273
Binding Update List in Mobile IPv6 Home Agent	273
Home Agents List	273
How Mobile IPv6 Works	274
Packet Headers in Mobile IPv6	274
IPv6 Neighbor Discovery with Mobile IPv6	274
How to Implement Mobile IPv6	275
Enabling Mobile IPv6 on the Router	275
Configuring Binding Information for Mobile IPv6	276
Filtering Mobile IPv6 Protocol Headers and Options	278
Controlling ICMP Unreachable Messages	279
Monitoring and Maintaining Mobile IPv6 on the Router	281
Verifying Mobile IPv6 Configuration and Operation	283
Sample Output for the show ipv6 mobile binding Command	283
Sample Output for the show ipv6 mobile globals Command	283
Sample Output for the show ipv6 mobile home-agent Command	284
Sample Output for the show ipv6 mobile traffic Command	284
Configuration Examples for Mobile IPv6	284
Enabling Mobile IPv6 on the Router: Example	285
Additional References	285
Related Documents	285
Standards	285
MIBs	286
RFCs	286
Technical Assistance	286
Implementing IPv6 over MPLS	287
Contents	287
Prerequisites for Implementing IPv6 over MPLS	287

Information About Implementing IPv6 over MPLS	288
Benefits of Deploying IPv6 over MPLS Backbones	288
IPv6 over a Circuit Transport over MPLS	288
IPv6 Using Tunnels on the Customer Edge Routers	289
IPv6 on the Provider Edge Routers (6PE)	290
6PE Multipath	291
How to Implement IPv6 over MPLS	292
Deploying IPv6 over a Circuit Transport over MPLS	292
Deploying IPv6 on the Provider Edge Routers (6PE)	292
6PE Network Configuration	292
Prerequisites	293
Restrictions	293
Specifying the Source Address Interface on a 6PE Router	293
Binding and Advertising the 6PE Label to Advertise Prefixes	294
Configuring iBGP Multipath Load Sharing	296
Verifying 6PE Configuration and Operation	297
Output Examples	298
Sample Output for the show bgp ipv6 Command	299
Sample Output for the show bgp ipv6 neighbors Command	299
Sample Output for the show mpls forwarding-table Command	299
Sample Output for the show bgp ipv6 Command	300
Sample Output for the show ipv6 cef Command	300
Sample Output for the show ipv6 route Command	300
Configuration Examples for IPv6 over MPLS	300
6PE Configuration Example	301
Where to Go Next	302
Additional References	303
Related Documents	303
Standards	303
MIBs	303
RFCs	303
Technical Assistance	304
Implementing IPv6 Multicast	305
Contents	305
Prerequisites for IPv6 Multicast	305
Restrictions for IPv6 Multicast	307
Information About IPv6 Multicast	308
IPv6 Multicast Overview	309

IPv6 Multicast Addressing	309
IPv6 Multicast Groups	311
Scoped Address Architecture	311
IPv6 Multicast Routing Implementation	312
Multicast Listener Discovery Protocol for IPv6	312
MLD Access Group	314
Explicit Tracking of Receivers	314
Multicast User Authentication and Profile Support	314
Protocol Independent Multicast	314
PIM-Sparse Mode	315
PIM-Source Specific Multicast	318
Routable Address Hello Option	320
Bidirectional PIM	321
Static Mroutes	321
MRIB	321
MFIB	321
Distributed MFIB	322
IPv6 Multicast Process Switching and Fast Switching	322
Multiprotocol BGP for the IPv6 Multicast Address Family	323
How to Implement IPv6 Multicast	323
Enabling IPv6 Multicast Routing	324
Prerequisites	324
Configuring the MLD Protocol	324
Customizing and Verifying MLD on an Interface	325
Implementing MLD Group Limits	328
Configuring Explicit Tracking of Receivers to Track Host Behavior	330
Configuring Multicast User Authentication and Profile Support	331
Resetting the MLD Traffic Counters	334
Clearing the MLD Interface Counters	335
Configuring PIM	335
Configuring PIM-SM and Displaying PIM-SM Information for a Group Range	336
Configuring PIM Options	337
Configuring Bidirectional PIM and Displaying Bidirectional PIM Information	339
Resetting the PIM Traffic Counters	340
Clearing the PIM Topology Table to Reset the MRIB Connection	341
Configuring a BSR	342
Configuring a BSR and Verifying BSR Information	342
Sending PIM RP Advertisements to the BSR	343
Configuring BSR for Use Within Scoped Zones	344
Configuring BSR Routers to Announce Scope-to-RP Mappings	345

Configuring SSM Mapping	346
Restrictions	346
Configuring Static Mroutes	347
Configuring IPv6 Multiprotocol BGP	349
Configuring an IPv6 Peer Group to Perform Multicast BGP Routing	349
Advertising Routes into IPv6 Multiprotocol BGP	351
Redistributing Prefixes into IPv6 Multiprotocol BGP	352
Assigning a BGP Administrative Distance	354
Generating Translate Updates for IPv6 Multicast BGP	355
Resetting BGP Sessions	356
Clearing External BGP Peers	356
Clearing IPv6 BGP Route Dampening Information	357
Clearing IPv6 BGP Flap Statistics	358
Using MFIB in IPv6 Multicast	358
Verifying MFIB Operation in IPv6 Multicast	358
Resetting MFIB Traffic Counters	359
Disabling Default Features in IPv6 Multicast	360
Disabling Embedded RP Support in IPv6 PIM	360
Turning Off IPv6 PIM on a Specified Interface	361
Disabling MLD Router-Side Processing	362
Disabling MFIB on the Router	363
Disabling MFIB on a Distributed Platform	363
Disabling MFIB Interrupt-Level IPv6 Multicast Forwarding	364
Troubleshooting IPv6 Multicast	365
Examples	367
Configuration Examples for IPv6 Multicast	375
Enabling IPv6 Multicast Routing: Example	375
Configuring PIM: Examples	376
Configuring PIM Options: Example	376
Configuring the MLD Protocol: Examples	376
Configuring Explicit Tracking of Receivers: Example	376
Configuring Mroutes: Example	377
Configuring an IPv6 Multiprotocol BGP Peer Group: Example	377
Advertising Routes into IPv6 Multiprotocol BGP: Example	377
Redistributing Prefixes into IPv6 Multiprotocol BGP: Example	377
Generating Translate Updates for IPv6 Multicast BGP: Example	377
Disabling Embedded RP Support in IPv6 PIM: Example	378
Turning Off IPv6 PIM on a Specified Interface: Example	378
Disabling MLD Router-Side Processing: Example	378
Disabling and Reenabling MFIB: Example	378

Additional References	378
Related Documents	378
Standards and Drafts	379
MIBs	379
RFCs	380
Technical Assistance	380
Implementing NAT Protocol Translation	381
Contents	381
Prerequisites for Implementing NAT-PT	381
Restrictions for Implementing NAT-PT	382
Information About Implementing NAT-PT	382
NAT-PT	382
Static NAT-PT Operation	383
Dynamic NAT-PT Operation	384
Port Address Translation (PAT) or Overload	385
IPv4-Mapped Operation	385
How to Implement NAT-PT	385
Configuring Basic IPv6 to IPv4 Connectivity for NAT-PT	386
NAT-PT Prefix	386
Configuring IPv4-Mapped NAT-PT	387
Configuring Mappings for IPv6 Hosts Accessing IPv4 Hosts	388
What to Do Next	391
Configuring Mappings for IPv4 Hosts Accessing IPv6 Hosts	391
Configuring Port Address Translation	392
What to Do Next	394
Verifying NAT-PT Configuration and Operation	394
Output Examples	395
Sample Output for the show ipv6 nat translations Command	396
Sample Output for the show ipv6 nat statistics Command	397
Sample Output for the clear ipv6 nat translation Command	398
Sample Output for the debug ipv6 nat Command	398
Configuration Examples for NAT-PT	398
Static NAT-PT Configuration: Example	399
Enabling Traffic to be Sent from an IPv6 Network to an IPv4 Network without Using IPv6 Destination Address Mapping: Example	399
Dynamic NAT-PT Configuration for IPv6 Hosts Accessing IPv4 Hosts: Example	399
Dynamic NAT-PT Configuration for IPv4 Hosts Accessing IPv6 Hosts Example	400
Where to Go Next	400

Additional References	401
Related Documents	401
Standards	401
MIBs	401
RFCs	401
Technical Assistance	402
Implementing NetFlow for IPv6	403
Contents	403
Prerequisites for Implementing NetFlow for IPv6	403
Information About Implementing NetFlow for IPv6	404
NetFlow for IPv6 Environments	404
How to Implement NetFlow for IPv6	404
Exporting NetFlow Statistics	404
Customizing the NetFlow Cache	406
Customizing the NetFlow Cache	406
Managing NetFlow Statistics	407
Configuring an Aggregation Cache	408
Prerequisites	408
Configuring a NetFlow Minimum Prefix Mask for Router-Based Aggregation	410
Configuring the Minimum Mask of a Prefix Aggregation Scheme	410
Configuring the Minimum Mask of a Destination-Prefix Aggregation Scheme	411
Configuring the Minimum Mask of a Source-Prefix Aggregation Scheme	411
Configuration Examples for Implementing NetFlow for IPv6	412
Configuring NetFlow in IPv6 Environments: Example	412
Where to Go Next	413
Additional References	413
Related Documents	413
Standards	414
MIBs	414
RFCs	414
Technical Assistance	414
Feature Information for Implementing NetFlow for IPv6	415
Implementing OSPF for IPv6	417
Contents	417
Prerequisites for Implementing OSPF for IPv6	417
Restrictions for Implementing OSPF for IPv6	418
Information About Implementing OSPF for IPv6	418

- How OSPF for IPv6 Works 419
- Comparison of OSPF for IPv6 and OSPF Version 2 419
- LSA Types for IPv6 420
 - NBMA in OSPF for IPv6 421
- Force SPF in OSPF for IPv6 421
- Load Balancing in OSPF for IPv6 421
- Importing Addresses into OSPF for IPv6 422
- OSPF for IPv6 Customization 422
- OSPF for IPv6 Authentication Support with IPsec 422
 - OSPF for IPv6 Virtual Links 423
- How to Implement OSPF for IPv6 423
 - Enabling OSPF for IPv6 on an Interface 423
 - Defining an OSPF for IPv6 Area Range 424
 - Prerequisites 425
 - Configuring IPsec on OSPF for IPv6 425
 - Defining Authentication on an Interface 426
 - Defining Encryption on an Interface 426
 - Defining Authentication in an OSPF Area 427
 - Defining Encryption in an OSPF Area 428
 - Defining Authentication and Encryption for a Virtual Link in an OSPF Area 429
 - Configuring NBMA Interfaces 430
 - Prerequisites 430
 - Restrictions 430
 - Forcing an SPF Calculation 431
 - Verifying OSPF for IPv6 Configuration and Operation 432
 - Examples 433
 - What to Do Next 436
- Configuration Examples for Implementing OSPF for IPv6 436
 - Enabling OSPF for IPv6 on an Interface Configuration: Example 436
 - Defining an OSPF for IPv6 Area Range: Example 436
 - Defining Authentication on an Interface: Example 437
 - Defining Authentication in an OSPF Area: Example 437
 - Configuring NBMA Interfaces Configuration: Example 437
 - Forcing SPF Configuration: Example 437
- Additional References 438
 - Related Documents 438
 - Standards 438
 - MIBs 438
 - RFCs 439

Technical Assistance	439
Implementing Policy-Based Routing for IPv6	441
Contents	441
Prerequisites for Policy-Based Routing for IPv6	441
Restrictions for Policy-Based Routing for IPv6	442
Information About Policy-Based Routing	442
Policy-Based Routing Overview	442
How Policy-Based Routing Works	443
Packet Matching	443
Packet Forwarding Using Set Statements	443
When to Use Policy-Based Routing	444
How to Implement Policy-Based Routing for IPv6	444
Enabling PBR on an Interface	444
Enabling Local PBR for IPv6	447
Enabling Cisco Express Forwarding-Switched PBR for IPv6	447
Verifying Configuration and Operation of PBR for IPv6	448
Troubleshooting PBR for IPv6	448
Examples	449
Configuration Examples for Policy-Based Routing for IPv6	449
Enabling PBR on an Interface: Example	450
Enabling Local PBR for IPv6: Example	450
Additional References	450
Related Documents	450
MIBs	451
Technical Assistance	451
Implementing QoS for IPv6 for Cisco IOS Software	453
Contents	453
Prerequisites for QoS for IPv6	453
Restrictions for QoS for IPv6	454
Information About QoS in IPv6	454
Implementation Strategy for QoS for IPv6	455
Packet Classification in IPv6	455
Policies and Class-Based Packet Marking in IPv6 Networks	456
Congestion Management in IPv6 Networks	456
Congestion Avoidance for IPv6 Traffic	456
Traffic Policing in IPv6 Environments	456
How to Implement QoS for IPv6	457

Restrictions for Classifying Traffic in IPv6 Networks	457
Specifying Marking Criteria for IPv6 Packets	457
Troubleshooting Tips	458
Using the Match Criteria to Manage IPv6 Traffic Flows	458
Configuration Examples for Using the Match Criteria to Manage IPv6 Traffic Flows	460
Verifying Packet Marking Criteria	460
Interpreting Packet Counters in show policy-map interface Command Output	460
Confirming the Service Policy	465
Configuration Examples for Implementing QoS for IPv6	467
Verification of CEF Switching: Example	467
Matching DSCP Value: Example	467
Additional References	468
Related Documents	468
MIBs	468
RFCs	468
Technical Assistance	469
Implementing RIP for IPv6	471
Contents	471
Prerequisites for Implementing RIP for IPv6	471
Information About Implementing RIP for IPv6	472
RIP for IPv6	472
How to Implement RIP for IPv6	472
Enabling IPv6 RIP	473
Prerequisites	473
Customizing IPv6 RIP	474
Redistributing Routes into an IPv6 RIP Routing Process	475
Configuring Tags for RIP Routes	476
Filtering IPv6 RIP Routing Updates	477
IPv6 Distribute Lists	478
IPv6 Prefix List Operand Keywords	478
Verifying IPv6 RIP Configuration and Operation	479
Output Examples	480
Sample Output for the show ipv6 rip Command	481
Sample Output for the show ipv6 route Command	482
Sample Output for the debug ipv6 rip Command	482
Configuration Examples for IPv6 RIP	483
IPv6 RIP Configuration: Example	483
Where to Go Next	483

Additional References	484
Related Documents	484
Standards	484
MIBs	484
RFCs	484
Technical Assistance	485
Implementing Static Routes for IPv6	487
Contents	487
Prerequisites for Implementing Static Routes for IPv6	487
Restrictions for Implementing Static Routes for IPv6	488
Information About Implementing Static Routes for IPv6	488
Static Routes	488
Directly Attached Static Routes	489
Recursive Static Routes	489
Fully Specified Static Routes	490
Floating Static Routes	490
How to Implement Static Routes for IPv6	490
Configuring a Static IPv6 Route	490
Static Routes in IPv6	491
What to Do Next	492
Configuring a Floating Static IPv6 Route	492
Verifying Static IPv6 Route Configuration and Operation	494
Configuration Examples for Implementing Static Routes for IPv6	496
Configuring Manual Summarization Example	496
Configuring Traffic Discard Example	497
Configuring a Fixed Default Route Example	497
Configuring a Floating Static Route Example	498
Configuration Examples Using the show ipv6 static, show ipv6 route, and debug ipv6 routing Commands	498
Sample Output from the show ipv6 static Command when No Options Are Specified in the Command Syntax	499
Sample Output from the show ipv6 static Command with the IPv6 Address and Prefix Command	499
Sample Output from the show ipv6 static interface Command	500
Sample Output from the show ipv6 static recursive Command	500
Sample Output from the show ipv6 static detail Command	500
Sample Output from the show ipv6 route Command	500
Sample Output for the debug ipv6 routing Command	501
Where to Go Next	501

- Additional References **502**
 - Related Documents **502**
 - Standards **502**
 - MIBs **502**
 - RFCs **503**
 - Technical Assistance **503**

Implementing Traffic Filters and Firewalls for IPv6 Security 505

- Contents **505**
- Prerequisites for Implementing Traffic Filters and Firewalls for IPv6 Security **505**
- Information About Implementing Traffic Filters and Firewalls for IPv6 Security **506**
 - Access Control Lists for IPv6 Traffic Filtering **506**
 - Cisco IOS Firewall for IPv6 **506**
 - PAM in Cisco IOS Firewall for IPv6 **507**
 - Cisco IOS Firewall Alerts, Audit Trails, and System Logging **507**
 - IPv6 Packet Inspection **508**
 - Tunneling Support **508**
 - Virtual Fragment Reassembly **508**
 - Cisco IOS Firewall Restrictions **508**
- How to Implement Traffic Filters and Firewalls for IPv6 Security **508**
 - Configuring IPv6 Traffic Filtering **508**
 - Restrictions **508**
 - Creating and Configuring an IPv6 ACL for Traffic Filtering **509**
 - Prerequisites **509**
 - Restrictions **509**
 - Applying the IPv6 ACL to an Interface **511**
 - What to Do Next **511**
 - Creating an IPv6 ACL for Traffic Filtering for Older Releases **511**
 - Restrictions **512**
 - Applying the IPv6 ACL to an Interface in Older Releases **513**
 - Controlling Access to a vty **514**
 - Access Class Filtering in IPv6 **514**
 - Creating an IPv6 ACL for Access Class Filtering **514**
 - Applying an IPv6 ACL to the Virtual Terminal Line **516**
 - Configuring Cisco IOS Firewall for IPv6 **517**
 - Configuring PAM for IPv6 **520**
 - Verifying IPv6 Security Configuration and Operation **523**
 - Troubleshooting IPv6 Security Configuration and Operation **525**
 - Examples **526**
- Configuration Examples for Implementing Traffic Filters and Firewalls for IPv6 Security **530**

Create and Apply IPv6 ACL: Examples	530
Controlling Access to a vty: Example	532
Configuring Cisco IOS Firewall for IPv6: Example	532
Additional References	533
Related Documents	533
Standards	533
MIBs	533
RFCs	534
Technical Assistance	534
Implementing Tunneling for IPv6	535
Contents	535
Prerequisites for Implementing Tunneling for IPv6	535
Restrictions for Implementing Tunneling for IPv6	536
Information About Implementing Tunneling for IPv6	536
Overlay Tunnels for IPv6	537
IPv6 Manually Configured Tunnels	538
GRE/IPv4 Tunnel Support for IPv6 Traffic	539
GRE/CLNS Tunnel Support for IPv4 and IPv6 Packets	539
Automatic 6to4 Tunnels	539
Automatic IPv4-Compatible IPv6 Tunnels	540
ISATAP Tunnels	540
IPv6 IPsec Site-to-Site Protection Using Virtual Tunnel Interface	541
How to Implement Tunneling for IPv6	541
Configuring Manual IPv6 Tunnels	541
Prerequisites	541
What to Do Next	543
Configuring GRE IPv6 Tunnels	543
Prerequisites	543
What to Do Next	544
Configuring 6to4 Tunnels	544
Prerequisites	544
Restrictions	544
What to Do Next	546
Configuring IPv4-Compatible IPv6 Tunnels	546
Prerequisites	546
What to Do Next	547
Configuring ISATAP Tunnels	547
Prerequisites	547

What to Do Next	548
Verifying IPv6 Tunnel Configuration and Operation	549
Examples	549
Configuration Examples for Implementing Tunneling for IPv6	551
Configuring Manual IPv6 Tunnels: Example	551
Configuring GRE Tunnels: Examples	552
Tunnel Destination Address for IPv6 Tunnel Example	552
Configuring CTunnels in GRE mode to Carry IPv6 Packets in CLNS: Example	553
Configuring 6to4 Tunnels Example	554
Configuring IPv4-Compatible IPv6 Tunnels Example	554
Configuring ISATAP Tunnels Example	555
Where to Go Next	555
Additional References	555
Related Documents	555
Standards	556
MIBs	556
RFCs	556
Technical Assistance	556



About Cisco IOS Software Documentation for Release 12.4

This chapter describes the objectives, audience, organization, and conventions of Cisco IOS software documentation. It also provides sources for obtaining documentation, technical assistance, and additional publications and information from Cisco Systems. It contains the following sections:

- [Documentation Objectives, page xxvii](#)
- [Audience, page xxvii](#)
- [Documentation Organization for Cisco IOS Release 12.4, page xxviii](#)
- [Document Conventions, page xxxiv](#)
- [Obtaining Documentation, page xxxv](#)
- [Documentation Feedback, page xxxvi](#)
- [Cisco Product Security Overview, page xxxvii](#)
- [Obtaining Technical Assistance, page xxxviii](#)
- [Obtaining Additional Publications and Information, page xxxix](#)

Documentation Objectives

Cisco IOS software documentation describes the tasks and commands available to configure and maintain Cisco networking devices.

Audience

The Cisco IOS software documentation set is intended primarily for users who configure and maintain Cisco networking devices (such as routers and switches) but who may not be familiar with the configuration and maintenance tasks, the relationship among tasks, or the Cisco IOS software commands necessary to perform particular tasks. The Cisco IOS software documentation set is also intended for those users experienced with Cisco IOS software who need to know about new features, new configuration options, and new software characteristics in the current Cisco IOS software release.

Documentation Organization for Cisco IOS Release 12.4

The Cisco IOS Release 12.4 documentation set consists of the configuration guide and command reference pairs listed in [Table 1](#) and the supporting documents listed in [Table 2](#). The configuration guides and command references are organized by technology. For the configuration guides:

- Some technology documentation, such as that for DHCP, contains features introduced in Releases 12.2T and 12.3T and, in some cases, Release 12.2S. To assist you in finding a particular feature, a roadmap document is provided.
- Other technology documentation, such as that for OSPF, consists of a chapter and accompanying Release 12.2T and 12.3T feature documents.



Note

In some cases, information contained in Release 12.2T and 12.3T feature documents augments or supersedes content in the accompanying documentation. Therefore it is important to review all feature documents for a particular technology.

[Table 1](#) lists the Cisco IOS Release 12.4 configuration guides and command references.

Table 1 Cisco IOS Release 12.4 Configuration Guides and Command References

Configuration Guide and Command Reference Titles	Description
IP	
Cisco IOS IP Addressing Services Configuration Guide , Release 12.4 Cisco IOS IP Addressing Services Command Reference , Release 12.4	The configuration guide is a task-oriented guide to configuring IP addressing and services, including Network Address Translation (NAT), Domain Name System (DNS), and Dynamic Host Configuration Protocol (DHCP). The command reference provides detailed information about the commands used in the configuration guide.
Cisco IOS IP Application Services Configuration Guide , Release 12.4 Cisco IOS IP Application Services Command Reference , Release 12.4	The configuration guide is a task-oriented guide to configuring IP application services, including IP access lists, Web Cache Communication Protocol (WCCP), Gateway Load Balancing Protocol (GLBP), Server Load Balancing (SLB), Hot Standby Router Protocol (HSRP), and Virtual Router Redundancy Protocol (VRRP). The command reference provides detailed information about the commands used in the configuration guide.
Cisco IOS IP Mobility Configuration Guide , Release 12.4 Cisco IOS IP Mobility Command Reference , Release 12.4	The configuration guide is a task-oriented guide to configuring Mobile IP and Cisco Mobile Networks. The command reference provides detailed information about the commands used in the configuration guide.
Cisco IOS IP Multicast Configuration Guide , Release 12.4 Cisco IOS IP Multicast Command Reference , Release 12.4	The configuration guide is a task-oriented guide to configuring IP multicast, including Protocol Independent Multicast (PIM), Internet Group Management Protocol (IGMP), Distance Vector Multicast Routing Protocol (DVMRP), and Multicast Source Discovery Protocol (MSDP). The command reference provides detailed information about the commands used in the configuration guide.
Cisco IOS IP Routing Protocols Configuration Guide , Release 12.4 Cisco IOS IP Routing Protocols Command Reference , Release 12.4	The configuration guide is a task-oriented guide to configuring IP routing protocols, including Border Gateway Protocol (BGP), Intermediate System-to-Intermediate System (IS-IS), and Open Shortest Path First (OSPF). The command reference provides detailed information about the commands used in the configuration guide.

Table 1 Cisco IOS Release 12.4 Configuration Guides and Command References (continued)

Configuration Guide and Command Reference Titles	Description
Cisco IOS IP Switching Configuration Guide , Release 12.4 Cisco IOS IP Switching Command Reference , Release 12.4	The configuration guide is a task-oriented guide to configuring IP switching features, including Cisco Express Forwarding, fast switching, and Multicast Distributed Switching (MDS). The command reference provides detailed information about the commands used in the configuration guide.
Cisco IOS IPv6 Configuration Guide , Release 12.4 Cisco IOS IPv6 Command Reference , Release 12.4	The configuration guide is a task-oriented guide to configuring IP version 6 (IPv6), including IPv6 broadband access, IPv6 data-link layer, IPv6 multicast routing, IPv6 quality of service (QoS), IPv6 routing, IPv6 services and management, and IPv6 tunnel services. The command reference provides detailed information about the commands used in the configuration guide.
Cisco IOS Optimized Edge Routing Configuration Guide , Release 12.4 Cisco IOS Optimized Edge Routing Command Reference , Release 12.4	The configuration guide is a task-oriented guide to configuring Optimized Edge Routing (OER) features, including OER prefix learning, OER prefix monitoring, OER operational modes, and OER policy configuration. The command reference provides detailed information about the commands used in the configuration guide.
Security and VPN	
Cisco IOS Security Configuration Guide , Release 12.4 Cisco IOS Security Command Reference , Release 12.4	The configuration guide is a task-oriented guide to configuring various aspects of security, including terminal access security, network access security, accounting, traffic filters, router access, and network data encryption with router authentication. The command reference provides detailed information about the commands used in the configuration guide.
QoS	
Cisco IOS Quality of Service Solutions Configuration Guide , Release 12.4 Cisco IOS Quality of Service Solutions Command Reference , Release 12.4	The configuration guide is a task-oriented guide to configuring quality of service (QoS) features, including traffic classification and marking, traffic policing and shaping, congestion management, congestion avoidance, and signaling. The command reference provides detailed information about the commands used in the configuration guide.
LAN Switching	
Cisco IOS LAN Switching Configuration Guide , Release 12.4 Cisco IOS LAN Switching Command Reference , Release 12.4	The configuration guide is a task-oriented guide to local-area network (LAN) switching features, including configuring routing between virtual LANs (VLANs) using Inter-Switch Link (ISL) encapsulation, IEEE 802.10 encapsulation, and IEEE 802.1Q encapsulation. The command reference provides detailed information about the commands used in the configuration guide.
Multiprotocol Label Switching (MPLS)	
Cisco IOS Multiprotocol Label Switching Configuration Guide , Release 12.4 Cisco IOS Multiprotocol Label Switching Command Reference , Release 12.4	The configuration guide is a task-oriented guide to configuring Multiprotocol Label Switching (MPLS), including MPLS Label Distribution Protocol, MPLS traffic engineering, and MPLS Virtual Private Networks (VPNs). The command reference provides detailed information about the commands used in the configuration guide.
Network Management	
Cisco IOS IP SLAs Configuration Guide , Release 12.4 Cisco IOS IP SLAs Command Reference , Release 12.4	The configuration guide is a task-oriented guide to configuring the Cisco IOS IP Service Level Assurances (IP SLAs) feature. The command reference provides detailed information about the commands used in the configuration guide.

Table 1 Cisco IOS Release 12.4 Configuration Guides and Command References (continued)

Configuration Guide and Command Reference Titles	Description
<p>Cisco IOS NetFlow Configuration Guide, Release 12.4</p> <p>Cisco IOS NetFlow Command Reference, Release 12.4</p>	<p>The configuration guide is a task-oriented guide to NetFlow features, including configuring NetFlow to analyze network traffic data, configuring NetFlow aggregation caches and export features, and configuring Simple Network Management Protocol (SNMP) and NetFlow MIB features. The command reference provides detailed information about the commands used in the configuration guide.</p>
<p>Cisco IOS Network Management Configuration Guide, Release 12.4</p> <p>Cisco IOS Network Management Command Reference, Release 12.4</p>	<p>The configuration guide is a task-oriented guide to network management features, including performing basic system management, performing troubleshooting and fault management, configuring Cisco Discovery Protocol, configuring Cisco Networking Services (CNS), configuring DistributedDirector, and configuring Simple Network Management Protocol (SNMP). The command reference provides detailed information about the commands used in the configuration guide.</p>
Voice	
<p>Cisco IOS Voice Configuration Library, Release 12.4</p> <p>Cisco IOS Voice Command Reference, Release 12.4</p>	<p>The configuration library is a task-oriented collection of configuration guides, application guides, a troubleshooting guide, feature documents, a library preface, a voice glossary, and more. It also covers Cisco IOS support for voice call control protocols, interoperability, physical and virtual interface management, and troubleshooting. In addition, the library includes documentation for IP telephony applications. The command reference provides detailed information about the commands used in the configuration library.</p>
Wireless/Mobility	
<p>Cisco IOS Mobile Wireless Gateway GPRS Support Node Configuration Guide, Release 12.4</p> <p>Cisco IOS Mobile Wireless Gateway GPRS Support Node Command Reference, Release 12.4</p>	<p>The configuration guide is a task-oriented guide to understanding and configuring a Cisco IOS Gateway GPRS Support Node (GGSN) in a 2.5G General Packet Radio Service (GPRS) and 3G Universal Mobile Telecommunication System (UMTS) network. The command reference provides detailed information about the commands used in the configuration guide.</p>
<p>Cisco IOS Mobile Wireless Home Agent Configuration Guide, Release 12.4</p> <p>Cisco IOS Mobile Wireless Home Agent Command Reference, Release 12.4</p>	<p>The configuration guide is a task-oriented guide to understanding and configuring the Cisco Mobile Wireless Home Agent, which is an anchor point for mobile terminals for which Mobile IP or Proxy Mobile IP services are provided. The command reference provides detailed information about the commands used in the configuration guide.</p>
<p>Cisco IOS Mobile Wireless Packet Data Serving Node Configuration Guide, Release 12.4</p> <p>Cisco IOS Mobile Wireless Packet Data Serving Node Command Reference, Release 12.4</p>	<p>The configuration guide is a task-oriented guide to understanding and configuring the Cisco Packet Data Serving Node (PDSN), a wireless gateway between the mobile infrastructure and standard IP networks that enables packet data services in a Code Division Multiple Access (CDMA) environment. The command reference provides detailed information about the commands used in the configuration guide.</p>

Table 1 Cisco IOS Release 12.4 Configuration Guides and Command References (continued)

Configuration Guide and Command Reference Titles	Description
<p><i>Cisco IOS Mobile Wireless Radio Access Networking Configuration Guide</i>, Release 12.4</p> <p><i>Cisco IOS Mobile Wireless Radio Access Networking Command Reference</i>, Release 12.4</p>	The configuration guide is a task-oriented guide to understanding and configuring Cisco IOS Radio Access Network products. The command reference provides detailed information about the commands used in the configuration guide.
Long Reach Ethernet (LRE) and Digital Subscriber Line (xDSL)	
<p><i>Cisco IOS Broadband and DSL Configuration Guide</i>, Release 12.4</p> <p><i>Cisco IOS Broadband and DSL Command Reference</i>, Release 12.4</p>	The configuration guide is a task-oriented guide to configuring broadband access aggregation and digital subscriber line features. The command reference provides detailed information about the commands used in the configuration guide.
<p><i>Cisco IOS Service Selection Gateway Configuration Guide</i>, Release 12.4</p> <p><i>Cisco IOS Service Selection Gateway Command Reference</i>, Release 12.4</p>	The configuration guide is a task-oriented guide to configuring Service Selection Gateway (SSG) features, including subscriber authentication, service access, and accounting. The command reference provides detailed information about the commands used in the configuration guide.
Dial—Access	
<p><i>Cisco IOS Dial Technologies Configuration Guide</i>, Release 12.4</p> <p><i>Cisco IOS Dial Technologies Command Reference</i>, Release 12.4</p>	The configuration guide is a task-oriented guide to configuring lines, modems, and ISDN services. This guide also contains information about configuring dialup solutions, including solutions for remote sites dialing in to a central office, Internet service providers (ISPs), ISP customers at home offices, enterprise WAN system administrators implementing dial-on-demand routing, and other corporate environments. The command reference provides detailed information about the commands used in the configuration guide.
<p><i>Cisco IOS VPDN Configuration Guide</i>, Release 12.4</p> <p><i>Cisco IOS VPDN Command Reference</i>, Release 12.4</p>	The configuration guide is a task-oriented guide to configuring Virtual Private Dialup Networks (VPDNs), including information about Layer 2 tunneling protocols, client-initiated VPDN tunneling, NAS-initiated VPDN tunneling, and multihop VPDN. The command reference provides detailed information about the commands used in the configuration guide.
Asynchronous Transfer Mode (ATM)	
<p><i>Cisco IOS Asynchronous Transfer Mode Configuration Guide</i>, Release 12.4</p> <p><i>Cisco IOS Asynchronous Transfer Mode Command Reference</i>, Release 12.4</p>	The configuration guide is a task-oriented guide to configuring Asynchronous Transfer Mode (ATM), including WAN ATM, LAN ATM, and multiprotocol over ATM (MPOA). The command reference provides detailed information about the commands used in the configuration guide.
WAN	
<p><i>Cisco IOS Wide-Area Networking Configuration Guide</i>, Release 12.4</p> <p><i>Cisco IOS Wide-Area Networking Command Reference</i>, Release 12.4</p>	The configuration guide is a task-oriented guide to configuring wide-area network (WAN) features, including Layer 2 Tunneling Protocol Version 3 (L2TPv3); Frame Relay; Link Access Procedure, Balanced (LAPB); and X.25. The command reference provides detailed information about the commands used in the configuration guide.

Table 1 Cisco IOS Release 12.4 Configuration Guides and Command References (continued)

Configuration Guide and Command Reference Titles	Description
System Management	
<p><i>Cisco IOS Configuration Fundamentals Configuration Guide</i>, Release 12.4</p> <p><i>Cisco IOS Configuration Fundamentals Command Reference</i>, Release 12.4</p>	<p>The configuration guide is a task-oriented guide to using Cisco IOS software to configure and maintain Cisco routers and access servers, including information about using the Cisco IOS command-line interface (CLI), loading and maintaining system images, using the Cisco IOS file system, using the Cisco IOS Web browser user interface (UI), and configuring basic file transfer services. The command reference provides detailed information about the commands used in the configuration guide.</p>
<p><i>Cisco IOS Interface and Hardware Component Configuration Guide</i>, Release 12.4</p> <p><i>Cisco IOS Interface and Hardware Component Command Reference</i>, Release 12.4</p>	<p>The configuration guide is a task-oriented guide to configuring and managing interfaces and hardware components, including dial shelves, LAN interfaces, logical interfaces, serial interfaces, and virtual interfaces. The command reference provides detailed information about the commands used in the configuration guide.</p>
IBM Technologies	
<p><i>Cisco IOS Bridging and IBM Networking Configuration Guide</i>, Release 12.4</p> <p><i>Cisco IOS Bridging Command Reference</i>, Release 12.4</p> <p><i>Cisco IOS IBM Networking Command Reference</i>, Release 12.4</p>	<p>The configuration guide is a task-oriented guide to configuring:</p> <ul style="list-style-type: none"> • Bridging features, including transparent and source-route transparent (SRT) bridging, source-route bridging (SRB), Token Ring Inter-Switch Link (TRISL), and Token Ring Route Switch Module (TRRSM). • IBM network features, including data-link switching plus (DLSw+), serial tunnel (STUN), and block serial tunnel (BSTUN); Logical Link Control, type 2 (LLC2), and Synchronous Data Link Control (SDLC); IBM Network Media Translation, including SDLC Logical Link Control (SDLLC) and Qualified Logical Link Control (QLLC); downstream physical unit (DSPU), Systems Network Architecture (SNA) service point, SNA Frame Relay Access, Advanced Peer-to-Peer Networking (APPN), native client interface architecture (NCIA) client/server topologies, and IBM Channel Attach. <p>The two command references provide detailed information about the commands used in the configuration guide.</p>
Additional and Legacy Protocols	
<p><i>Cisco IOS AppleTalk Configuration Guide</i>, Release 12.4</p> <p><i>Cisco IOS AppleTalk Command Reference</i>, Release 12.4</p>	<p>The configuration guide is a task-oriented guide to configuring the AppleTalk protocol. The command reference provides detailed information about the commands used in the configuration guide.</p>
<p><i>Cisco IOS DECnet Configuration Guide</i>, Release 12.4</p> <p><i>Cisco IOS DECnet Command Reference</i>, Release 12.4</p>	<p>The configuration guide is a task-oriented guide to configuring the DECnet protocol. The command reference provides detailed information about the commands used in the configuration guide.</p>
<p><i>Cisco IOS ISO CLNS Configuration Guide</i>, Release 12.4</p> <p><i>Cisco IOS ISO CLNS Command Reference</i>, Release 12.4</p>	<p>The configuration guide is a task-oriented guide to configuring International Organization for Standardization (ISO) Connectionless Network Service (CLNS). The command reference provides detailed information about the commands used in the configuration guide.</p>

Table 1 Cisco IOS Release 12.4 Configuration Guides and Command References (continued)

Configuration Guide and Command Reference Titles	Description
<i>Cisco IOS Novell IPX Configuration Guide</i> , Release 12.4 <i>Cisco IOS Novell IPX Command Reference</i> , Release 12.4	The configuration guide is a task-oriented guide to configuring the Novell Internetwork Packet Exchange (IPX) protocol. The command reference provides detailed information about the commands used in the configuration guide.
<i>Cisco IOS Terminal Services Configuration Guide</i> , Release 12.4 <i>Cisco IOS Terminal Services Command Reference</i> , Release 12.4	The configuration guide is a task-oriented guide to configuring terminal services, including DEC, local-area transport (LAT), and X.25 packet assembler/disassembler (PAD). The command reference provides detailed information about the commands used in the configuration guide.

Table 2 lists the documents and resources that support the Cisco IOS Release 12.4 software configuration guides and command references.

Table 2 Cisco IOS Release 12.4 Supporting Documents and Resources

Document Title	Description
<i>Cisco IOS Master Commands List</i> , Release 12.4	An alphabetical listing of all the commands documented in the Cisco IOS Release 12.4 command references.
<i>Cisco IOS New, Modified, Replaced, and Removed Commands</i> , Release 12.4	A listing of all the new, modified, replaced and removed commands since Cisco IOS Release 12.3, grouped by Release 12.3T maintenance release and ordered alphabetically within each group.
<i>Cisco IOS New and Modified Commands</i> , Release 12.3	A listing of all the new, modified, and replaced commands since Cisco IOS Release 12.2, grouped by Release 12.2T maintenance release and ordered alphabetically within each group.
<i>Cisco IOS System Messages, Volume 1 of 2</i> <i>Cisco IOS System Messages, Volume 2 of 2</i>	Listings and descriptions of Cisco IOS system messages. Not all system messages indicate problems with your system. Some are purely informational, and others may help diagnose problems with communications lines, internal hardware, or the system software.
<i>Cisco IOS Debug Command Reference</i> , Release 12.4	An alphabetical listing of the debug commands and their descriptions. Documentation for each command includes a brief description of its use, command syntax, and usage guidelines.
<i>Release Notes</i> , Release 12.4	A description of general release information, including information about supported platforms, feature sets, platform-specific notes, and Cisco IOS software defects.
<i>Internetworking Terms and Acronyms</i>	Compilation and definitions of the terms and acronyms used in the internetworking industry.

Table 2 Cisco IOS Release 12.4 Supporting Documents and Resources (continued)

Document Title	Description
RFCs	RFCs are standards documents maintained by the Internet Engineering Task Force (IETF). Cisco IOS software documentation references supported RFCs when applicable. The full text of referenced RFCs may be obtained at the following URL: http://www.rfc-editor.org/
MIBs	MIBs are used for network monitoring. To locate and download MIBs for selected platforms, Cisco IOS releases, and feature sets, use Cisco MIB Locator found at the following URL: http://www.cisco.com/go/mibs

Document Conventions

Within Cisco IOS software documentation, the term *router* is generally used to refer to a variety of Cisco products (for example, routers, access servers, and switches). Routers, access servers, and other networking devices that support Cisco IOS software are shown interchangeably within examples. These products are used only for illustrative purposes; that is, an example that shows one product does not necessarily indicate that other products are not supported.

The Cisco IOS documentation set uses the following conventions:

Convention	Description
^ or Ctrl	The ^ and Ctrl symbols represent the Control key. For example, the key combination ^D or Ctrl-D means hold down the Control key while you press the D key. Keys are indicated in capital letters but are not case sensitive.
<i>string</i>	A string is a nonquoted set of characters shown in italics. For example, when setting an SNMP community string to <i>public</i> , do not use quotation marks around the string or the string will include the quotation marks.

Command syntax descriptions use the following conventions:

Convention	Description
bold	Bold text indicates commands and keywords that you enter literally as shown.
<i>italics</i>	Italic text indicates arguments for which you supply values.
[x]	Square brackets enclose an optional element (keyword or argument).
	A vertical line indicates a choice within an optional or required set of keywords or arguments.
[x y]	Square brackets enclosing keywords or arguments separated by a vertical line indicate an optional choice.
{x y}	Braces enclosing keywords or arguments separated by a vertical line indicate a required choice.

Nested sets of square brackets or braces indicate optional or required choices within optional or required elements. For example:

Convention	Description
[x {y z}]	Braces and a vertical line within square brackets indicate a required choice within an optional element.

Examples use the following conventions:

Convention	Description
screen	Examples of information displayed on the screen are set in Courier font.
bold screen	Examples of text that you must enter are set in Courier bold font.
< >	Angle brackets enclose text that is not printed to the screen, such as passwords, and are used in contexts in which the italic document convention is not available, such as ASCII text.
!	An exclamation point at the beginning of a line indicates a comment line. (Exclamation points are also displayed by the Cisco IOS software for certain processes.)
[]	Square brackets enclose default responses to system prompts.

The following conventions are used to attract the attention of the reader:



Caution

Means *reader be careful*. In this situation, you might do something that could result in equipment damage or loss of data.



Note

Means *reader take note*. Notes contain suggestions or references to material not covered in the manual.



Timesaver

Means the *described action saves time*. You can save time by performing the action described in the paragraph.

Obtaining Documentation

Cisco documentation and additional literature are available on Cisco.com. Cisco also provides several ways to obtain technical assistance and other technical resources. These sections explain how to obtain technical information from Cisco Systems.

Cisco.com

You can access the most current Cisco documentation and technical support at this URL:

<http://www.cisco.com/techsupport>

You can access the Cisco website at this URL:

<http://www.cisco.com>

You can access international Cisco websites at this URL:

http://www.cisco.com/public/countries_languages.shtml

Product Documentation DVD

Cisco documentation and additional literature are available in the Product Documentation DVD package, which may have shipped with your product. The Product Documentation DVD is updated regularly and may be more current than printed documentation.

The Product Documentation DVD is a comprehensive library of technical product documentation on portable media. The DVD enables you to access multiple versions of hardware and software installation, configuration, and command guides for Cisco products and to view technical documentation in HTML. With the DVD, you have access to the same documentation that is found on the Cisco website without being connected to the Internet. Certain products also have .pdf versions of the documentation available.

The Product Documentation DVD is available as a single unit or as a subscription. Registered Cisco.com users (Cisco direct customers) can order a Product Documentation DVD (product number DOC-DOCDVD=) from Cisco Marketplace at this URL:

<http://www.cisco.com/go/marketplace/>

Ordering Documentation

Beginning June 30, 2005, registered Cisco.com users may order Cisco documentation at the Product Documentation Store in the Cisco Marketplace at this URL:

<http://www.cisco.com/go/marketplace/>

Nonregistered Cisco.com users can order technical documentation from 8:00 a.m. to 5:00 p.m. (0800 to 1700) PDT by calling 1 866 463-3487 in the United States and Canada, or elsewhere by calling 011 408 519-5055. You can also order documentation by e-mail at tech-doc-store-mkpl@external.cisco.com or by fax at 1 408 519-5001 in the United States and Canada, or elsewhere at 011 408 519-5001.

Documentation Feedback

You can rate and provide feedback about Cisco technical documents by completing the online feedback form that appears with the technical documents on Cisco.com.

You can send comments about Cisco documentation to bug-doc@cisco.com.

You can submit comments by using the response card (if present) behind the front cover of your document or by writing to the following address:

Cisco Systems
Attn: Customer Document Ordering
170 West Tasman Drive
San Jose, CA 95134-9883

We appreciate your comments.

Cisco Product Security Overview

Cisco provides a free online Security Vulnerability Policy portal at this URL:

http://www.cisco.com/en/US/products/products_security_vulnerability_policy.html

From this site, you can perform these tasks:

- Report security vulnerabilities in Cisco products.
- Obtain assistance with security incidents that involve Cisco products.
- Register to receive security information from Cisco.

A current list of security advisories and notices for Cisco products is available at this URL:

<http://www.cisco.com/go/psirt>

If you prefer to see advisories and notices as they are updated in real time, you can access a Product Security Incident Response Team Really Simple Syndication (PSIRT RSS) feed from this URL:

http://www.cisco.com/en/US/products/products_psirt_rss_feed.html

Reporting Security Problems in Cisco Products

Cisco is committed to delivering secure products. We test our products internally before we release them, and we strive to correct all vulnerabilities quickly. If you think that you might have identified a vulnerability in a Cisco product, contact PSIRT:

- Emergencies—security-alert@cisco.com

An emergency is either a condition in which a system is under active attack or a condition for which a severe and urgent security vulnerability should be reported. All other conditions are considered nonemergencies.

- Nonemergencies—psirt@cisco.com

In an emergency, you can also reach PSIRT by telephone:

- 1 877 228-7302
- 1 408 525-6532



Tip

We encourage you to use Pretty Good Privacy (PGP) or a compatible product to encrypt any sensitive information that you send to Cisco. PSIRT can work from encrypted information that is compatible with PGP versions 2.x through 8.x.

Never use a revoked or an expired encryption key. The correct public key to use in your correspondence with PSIRT is the one linked in the Contact Summary section of the Security Vulnerability Policy page at this URL:

http://www.cisco.com/en/US/products/products_security_vulnerability_policy.html

The link on this page has the current PGP key ID in use.

Obtaining Technical Assistance

Cisco Technical Support provides 24-hour-a-day award-winning technical assistance. The Cisco Technical Support & Documentation website on Cisco.com features extensive online support resources. In addition, if you have a valid Cisco service contract, Cisco Technical Assistance Center (TAC) engineers provide telephone support. If you do not have a valid Cisco service contract, contact your reseller.

Cisco Technical Support & Documentation Website

The Cisco Technical Support & Documentation website provides online documents and tools for troubleshooting and resolving technical issues with Cisco products and technologies. The website is available 24 hours a day, at this URL:

<http://www.cisco.com/techsupport>

Access to all tools on the Cisco Technical Support & Documentation website requires a Cisco.com user ID and password. If you have a valid service contract but do not have a user ID or password, you can register at this URL:

<http://tools.cisco.com/RPF/register/register.do>



Note

Use the Cisco Product Identification (CPI) tool to locate your product serial number before submitting a web or phone request for service. You can access the CPI tool from the Cisco Technical Support & Documentation website by clicking the **Tools & Resources** link. Choose **Cisco Product Identification Tool** from the Alphabetical Index drop-down list, or click the **Cisco Product Identification Tool** link under Alerts & RMAs. The CPI tool offers three search options: by product ID or model name; by tree view; or for certain products, by copying and pasting **show** command output. Search results show an illustration of your product with the serial number label location highlighted. Locate the serial number label on your product and record the information before placing a service call.

Submitting a Service Request

Using the online TAC Service Request Tool is the fastest way to open S3 and S4 service requests. (S3 and S4 service requests are those in which your network is minimally impaired or for which you require product information.) After you describe your situation, the TAC Service Request Tool provides recommended solutions. If your issue is not resolved using the recommended resources, your service request is assigned to a Cisco engineer. The TAC Service Request Tool is located at this URL:

<http://www.cisco.com/techsupport/servicerequest>

For S1 or S2 service requests or if you do not have Internet access, contact the Cisco TAC by telephone. (S1 or S2 service requests are those in which your production network is down or severely degraded.) Cisco engineers are assigned immediately to S1 and S2 service requests to help keep your business operations running smoothly.

To open a service request by telephone, use one of the following numbers:

Asia-Pacific: +61 2 8446 7411 (Australia: 1 800 805 227)

EMEA: +32 2 704 55 55

USA: 1 800 553-2447

For a complete list of Cisco TAC contacts, go to this URL:

<http://www.cisco.com/techsupport/contacts>

Definitions of Service Request Severity

To ensure that all service requests are reported in a standard format, Cisco has established severity definitions.

Severity 1 (S1)—Your network is “down,” or there is a critical impact to your business operations. You and Cisco will commit all necessary resources around the clock to resolve the situation.

Severity 2 (S2)—Operation of an existing network is severely degraded, or significant aspects of your business operation are negatively affected by inadequate performance of Cisco products. You and Cisco will commit full-time resources during normal business hours to resolve the situation.

Severity 3 (S3)—Operational performance of your network is impaired, but most business operations remain functional. You and Cisco will commit resources during normal business hours to restore service to satisfactory levels.

Severity 4 (S4)—You require information or assistance with Cisco product capabilities, installation, or configuration. There is little or no effect on your business operations.

Obtaining Additional Publications and Information

Information about Cisco products, technologies, and network solutions is available from various online and printed sources.

- Cisco Marketplace provides a variety of Cisco books, reference guides, documentation, and logo merchandise. Visit Cisco Marketplace, the company store, at this URL:
<http://www.cisco.com/go/marketplace/>
- *Cisco Press* publishes a wide range of general networking, training and certification titles. Both new and experienced users will benefit from these publications. For current Cisco Press titles and other information, go to Cisco Press at this URL:
<http://www.ciscopress.com>
- *Packet* magazine is the Cisco Systems technical user magazine for maximizing Internet and networking investments. Each quarter, Packet delivers coverage of the latest industry trends, technology breakthroughs, and Cisco products and solutions, as well as network deployment and troubleshooting tips, configuration examples, customer case studies, certification and training information, and links to scores of in-depth online resources. You can access Packet magazine at this URL:
<http://www.cisco.com/packet>
- *iQ Magazine* is the quarterly publication from Cisco Systems designed to help growing companies learn how they can use technology to increase revenue, streamline their business, and expand services. The publication identifies the challenges facing these companies and the technologies to help solve them, using real-world case studies and business strategies to help readers make sound technology investment decisions. You can access iQ Magazine at this URL:

<http://www.cisco.com/go/iqmagazine>

or view the digital edition at this URL:

<http://ciscoiq.texterity.com/ciscoiq/sample/>

- *Internet Protocol Journal* is a quarterly journal published by Cisco Systems for engineering professionals involved in designing, developing, and operating public and private internets and intranets. You can access the *Internet Protocol Journal* at this URL:
<http://www.cisco.com/ipj>
- Networking products offered by Cisco Systems, as well as customer support services, can be obtained at this URL:
<http://www.cisco.com/en/US/products/index.html>
- Networking Professionals Connection is an interactive website for networking professionals to share questions, suggestions, and information about networking products and technologies with Cisco experts and other networking professionals. Join a discussion at this URL:
<http://www.cisco.com/discuss/networking>
- World-class networking training is available from Cisco. You can view current offerings at this URL:
<http://www.cisco.com/en/US/learning/index.html>



Using Cisco IOS Software for Release 12.4

This chapter provides tips for understanding and configuring Cisco IOS software using the command-line interface (CLI). It contains the following sections:

- [Understanding Command Modes, page xli](#)
- [Getting Help, page xlii](#)
- [Using the no and default Forms of Commands, page xlvi](#)
- [Saving Configuration Changes, page xlvi](#)
- [Filtering Output from the show and more Commands, page xlvii](#)
- [Finding Additional Feature Support Information, page xlvii](#)

For an overview of Cisco IOS software configuration, see the [Cisco IOS Configuration Fundamentals Configuration Guide](#).

For information on the conventions used in the Cisco IOS software documentation set, see the “[About Cisco IOS Software Documentation for Release 12.4](#)” chapter.

Understanding Command Modes

You use the CLI to access Cisco IOS software. Because the CLI is divided into many different modes, the commands available to you at any given time depend on the mode that you are currently in. Entering a question mark (?) at the CLI prompt allows you to obtain a list of commands available for each command mode.

When you log in to a Cisco device, the device is initially in user EXEC mode. User EXEC mode contains only a limited subset of commands. To have access to all commands, you must enter privileged EXEC mode by entering the **enable** command and a password (when required). From privileged EXEC mode you have access to both user EXEC and privileged EXEC commands. Most EXEC commands are used independently to observe status or to perform a specific function. For example, **show** commands are used to display important status information, and **clear** commands allow you to reset counters or interfaces. The EXEC commands are not saved when the software reboots.

Configuration modes allow you to make changes to the running configuration. If you later save the running configuration to the startup configuration, these changed commands are stored when the software is rebooted. To enter specific configuration modes, you must start at global configuration mode. From global configuration mode, you can enter interface configuration mode and a variety of other modes, such as protocol-specific modes.

ROM monitor mode is a separate mode used when the Cisco IOS software cannot load properly. If a valid software image is not found when the software boots or if the configuration file is corrupted at startup, the software might enter ROM monitor mode.

Table 1 describes how to access and exit various common command modes of the Cisco IOS software. It also shows examples of the prompts displayed for each mode.

Table 1 Accessing and Exiting Command Modes

Command Mode	Access Method	Prompt	Exit Method
User EXEC	Log in.	Router>	Use the logout command.
Privileged EXEC	From user EXEC mode, use the enable command.	Router#	To return to user EXEC mode, use the disable command.
Global configuration	From privileged EXEC mode, use the configure terminal command.	Router(config)#	To return to privileged EXEC mode from global configuration mode, use the exit or end command.
Interface configuration	From global configuration mode, specify an interface using an interface command.	Router(config-if)#	To return to global configuration mode, use the exit command. To return to privileged EXEC mode, use the end command.
ROM monitor	From privileged EXEC mode, use the reload command. Press the Break key during the first 60 seconds while the system is booting.	>	To exit ROM monitor mode, use the continue command.

For more information on command modes, see the “Using the Cisco IOS Command-Line Interface” chapter in the *Cisco IOS Configuration Fundamentals Configuration Guide*.

Getting Help

Entering a question mark (?) at the CLI prompt displays a list of commands available for each command mode. You can also get a list of keywords and arguments associated with any command by using the context-sensitive help feature.

To get help specific to a command mode, a command, a keyword, or an argument, use one of the following commands:

Command	Purpose
help	Provides a brief description of the help system in any command mode.
<i>abbreviated-command-entry?</i>	Provides a list of commands that begin with a particular character string. (No space between command and question mark.)
<i>abbreviated-command-entry<Tab></i>	Completes a partial command name.

Command	Purpose
?	Lists all commands available for a particular command mode.
<i>command</i> ?	Lists the keywords or arguments that you must enter next on the command line. (Space between command and question mark.)

Example: How to Find Command Options

This section provides an example of how to display syntax for a command. The syntax can consist of optional or required keywords and arguments. To display keywords and arguments for a command, enter a question mark (?) at the configuration prompt or after entering part of a command followed by a space. The Cisco IOS software displays a list and brief description of available keywords and arguments. For example, if you were in global configuration mode and wanted to see all the keywords or arguments for the **arap** command, you would type **arap ?**.

The <cr> symbol in command help output stands for “carriage return.” On older keyboards, the carriage return key is the Return key. On most modern keyboards, the carriage return key is the Enter key. The <cr> symbol at the end of command help output indicates that you have the option to press **Enter** to complete the command and that the arguments and keywords in the list preceding the <cr> symbol are optional. The <cr> symbol by itself indicates that no more arguments or keywords are available and that you must press **Enter** to complete the command.

[Table 2](#) shows examples of how you can use the question mark (?) to assist you in entering commands. The table steps you through configuring an IP address on a serial interface on a Cisco 7206 router that is running Cisco IOS Release 12.0(3).

Table 2 How to Find Command Options

Command	Comment
Router> enable Password: <password> Router#	Enter the enable command and password to access privileged EXEC commands. You are in privileged EXEC mode when the prompt changes to Router#.
Router# configure terminal Enter configuration commands, one per line. End with CNTL/Z. Router(config)#	Enter the configure terminal privileged EXEC command to enter global configuration mode. You are in global configuration mode when the prompt changes to Router(config)#.

Table 2 How to Find Command Options (continued)

Command	Comment
<pre>Router(config)# interface serial ? <0-6> Serial interface number Router(config)# interface serial 4 ? / Router(config)# interface serial 4/ ? <0-3> Serial interface number Router(config)# interface serial 4/0 ? <cr> Router(config)# interface serial 4/0 Router(config-if)#</pre>	<p>Enter interface configuration mode by specifying the serial interface that you want to configure using the interface serial global configuration command.</p> <p>Enter ? to display what you must enter next on the command line. In this example, you must enter the serial interface slot number and port number, separated by a forward slash.</p> <p>When the <cr> symbol is displayed, you can press Enter to complete the command.</p> <p>You are in interface configuration mode when the prompt changes to Router(config-if)#.</p>
<pre>Router(config-if)# ? Interface configuration commands: . . . ip Interface Internet Protocol config commands keepalive Enable keepalive lan-name LAN Name command llc2 LLC2 Interface Subcommands load-interval Specify interval for load calculation for an interface locaddr-priority Assign a priority group logging Configure logging for interface loopback Configure internal loopback on an interface mac-address Manually set interface MAC address mls mls router sub/interface commands mpoa MPOA interface configuration commands mtu Set the interface Maximum Transmission Unit (MTU) netbios Use a defined NETBIOS access list or enable name-caching no Negate a command or set its defaults nrzi-encoding Enable use of NRZI encoding ntp Configure NTP . . . Router(config-if)#</pre>	<p>Enter ? to display a list of all the interface configuration commands available for the serial interface. This example shows only some of the available interface configuration commands.</p>

Table 2 How to Find Command Options (continued)

Command	Comment
<pre>Router(config-if)# ip ? Interface IP configuration subcommands: access-group Specify access control for packets accounting Enable IP accounting on this interface address Set the IP address of an interface authentication authentication subcommands bandwidth-percent Set EIGRP bandwidth limit broadcast-address Set the broadcast address of an interface cgmp Enable/disable CGMP directed-broadcast Enable forwarding of directed broadcasts dvmrp DVMRP interface commands hello-interval Configures IP-EIGRP hello interval helper-address Specify a destination address for UDP broadcasts hold-time Configures IP-EIGRP hold time . . . Router(config-if)# ip</pre>	<p>Enter the command that you want to configure for the interface. This example uses the ip command.</p> <p>Enter ? to display what you must enter next on the command line. This example shows only some of the available interface IP configuration commands.</p>
<pre>Router(config-if)# ip address ? A.B.C.D IP address negotiated IP Address negotiated over PPP Router(config-if)# ip address</pre>	<p>Enter the command that you want to configure for the interface. This example uses the ip address command.</p> <p>Enter ? to display what you must enter next on the command line. In this example, you must enter an IP address or the negotiated keyword.</p> <p>A carriage return (<cr>) is not displayed; therefore, you must enter additional keywords or arguments to complete the command.</p>
<pre>Router(config-if)# ip address 172.16.0.1 ? A.B.C.D IP subnet mask Router(config-if)# ip address 172.16.0.1</pre>	<p>Enter the keyword or argument that you want to use. This example uses the 172.16.0.1 IP address.</p> <p>Enter ? to display what you must enter next on the command line. In this example, you must enter an IP subnet mask.</p> <p>A <cr> is not displayed; therefore, you must enter additional keywords or arguments to complete the command.</p>

Table 2 How to Find Command Options (continued)

Command	Comment
Router(config-if)# ip address 172.16.0.1 255.255.255.0 ? secondary Make this IP address a secondary address <cr>	Enter the IP subnet mask. This example uses the 255.255.255.0 IP subnet mask.
Router(config-if)# ip address 172.16.0.1 255.255.255.0	Enter ? to display what you must enter next on the command line. In this example, you can enter the secondary keyword, or you can press Enter . A <cr> is displayed; you can press Enter to complete the command, or you can enter another keyword.
Router(config-if)# ip address 172.16.0.1 255.255.255.0 Router(config-if)#	In this example, Enter is pressed to complete the command.

Using the no and default Forms of Commands

Almost every configuration command has a **no** form. In general, use the **no** form to disable a function. Use the command without the **no** keyword to reenable a disabled function or to enable a function that is disabled by default. For example, IP routing is enabled by default. To disable IP routing, use the **no ip routing** command; to reenable IP routing, use the **ip routing** command. The Cisco IOS software command reference publications provide the complete syntax for the configuration commands and describe what the **no** form of a command does.

Configuration commands can also have a **default** form, which returns the command settings to the default values. Most commands are disabled by default, so in such cases using the **default** form has the same result as using the **no** form of the command. However, some commands are enabled by default and have variables set to certain default values. In these cases, the **default** form of the command enables the command and sets the variables to their default values. The Cisco IOS software command reference publications describe the effect of the **default** form of a command if the command functions differently than the **no** form.

Saving Configuration Changes

Use the **copy system:running-config nvram:startup-config** command or the **copy running-config startup-config** command to save your configuration changes to the startup configuration so that the changes will not be lost if the software reloads or a power outage occurs. For example:

```
Router# copy system:running-config nvram:startup-config
Building configuration...
```

It might take a minute or two to save the configuration. After the configuration has been saved, the following output appears:

```
[OK]
Router#
```

On most platforms, this task saves the configuration to NVRAM. On the Class A flash file system platforms, this task saves the configuration to the location specified by the CONFIG_FILE environment variable. The CONFIG_FILE variable defaults to NVRAM.

Filtering Output from the show and more Commands

You can search and filter the output of **show** and **more** commands. This functionality is useful if you need to sort through large amounts of output or if you want to exclude output that you need not see.

To use this functionality, enter a **show** or **more** command followed by the “pipe” character (`|`); one of the keywords **begin**, **include**, or **exclude**; and a regular expression on which you want to search or filter (the expression is case-sensitive):

```
command | {begin | include | exclude} regular-expression
```

The output matches certain lines of information in the configuration file. The following example illustrates how to use output modifiers with the **show interface** command when you want the output to include only lines in which the expression “protocol” appears:

```
Router# show interface | include protocol

FastEthernet0/0 is up, line protocol is up
Serial4/0 is up, line protocol is up
Serial4/1 is up, line protocol is up
Serial4/2 is administratively down, line protocol is down
Serial4/3 is administratively down, line protocol is down
```

For more information on the search and filter functionality, see the “Using the Cisco IOS Command-Line Interface” chapter in the *Cisco IOS Configuration Fundamentals Configuration Guide*.

Finding Additional Feature Support Information

If you want to use a specific Cisco IOS software feature, you will need to determine in which Cisco IOS software images that feature is supported. Feature support in Cisco IOS software images depends on three main factors: the software version (called the “Release”), the hardware model (the “Platform” or “Series”), and the “Feature Set” (collection of specific features designed for a certain network environment). Although the Cisco IOS software documentation set documents feature support information for Release 12.4 as a whole, it does not generally provide specific hardware and feature set information.

To determine the correct combination of Release (software version), Platform (hardware version), and Feature Set needed to run a particular feature (or any combination of features), use Feature Navigator.

Use Cisco Feature Navigator to find information about platform support and software image support. Cisco Feature Navigator enables you to determine which Cisco IOS and Catalyst OS software images support a specific software release, feature set, or platform. To access Cisco Feature Navigator, go to <http://www.cisco.com/go/cfn>. An account on Cisco.com is not required.

Software features may also have additional limitations or restrictions. For example, a minimum amount of system memory may be required. Or there may be known issues for features on certain platforms that have not yet been resolved (called “Caveats”). For the latest information about these limitations, see the release notes for the appropriate Cisco IOS software release. Release notes provide detailed installation instructions, new feature descriptions, system requirements, limitations and restrictions, caveats, and troubleshooting information for a particular software release.



Start Here: Cisco IOS Software Release Specifics for IPv6 Features

This document lists the IP version 6 (IPv6) features supported in the 12.0S, 12.xT, 12.2S family, 12.3, and 12.4 Cisco IOS software release trains.

The IPv6 for Cisco IOS Software feature documentation provides implementation and command reference information for IPv6 features supported in the Cisco IOS software. This Start Here document details only the Cisco IOS software release specifics for IPv6 features. *Not all IPv6 features may be supported in your Cisco IOS software release.* We strongly recommend that you read this entire document before reading the other IPv6 for Cisco IOS software feature documentation.

The *Cisco IOS IPv6 Configuration Library*, which includes this document, is located at the following website:

http://www.cisco.com/univercd/cc/td/doc/product/software/ios124/hipv6_c/index.htm

The *Cisco IOS IPv6 Command Reference* is located at the following website:

http://www.cisco.com/univercd/cc/td/doc/product/software/ios124/hipv6_r/index.htm

The following sections are included in this document:

- [Cisco IOS Software Platform Dependencies and Restrictions, page 1](#)
- [Cisco IOS IPv6 Features and Supported Software Releases, page 2](#)
- [Cisco Platforms Supporting IPv6 Hardware Forwarding, page 11](#)
- [Supported RFCs, page 13](#)
- [Related Documents, page 15](#)

Cisco IOS Software Platform Dependencies and Restrictions

- IPv6 features are supported in the 12.0S, 12.xT, 12.2S, 12.2SB, 12.2SRA, 12.3, and 12.4 Cisco IOS software release trains, starting at Cisco IOS Release 12.0(22)S, 12.2(2)T, 12.2(14)S, 12.2(28)SB, 12.2(33)SRA, 12.3, and 12.4, respectively. See [Table 3](#) to determine which IPv6 features are supported in each release of the 12.0S, 12.xT, 12.2S, 12.2SB, 12.2SRA, 12.3, and 12.4 Cisco IOS software trains.
- IPv6 was introduced on the 12.0(21)ST Cisco IOS software release train, which was merged with the 12.0S Cisco IOS software release train starting at Cisco IOS Release 12.0(22)S. The 12.0S Cisco IOS software release train provides IPv6 support on Cisco 12000 series Internet routers and Cisco 10720 Internet routers only.

- The 12.2S Cisco IOS release train comprises a family of release trains, each supporting different platforms as follows:
 - The 12.2SB Cisco IOS release train comprises the Cisco 10000, 7304, 7301, and 7200 series.



Note Not all features for Cisco IOS Release 12.2(28)SB are supported on the Cisco 10000 series routers. For further information on Cisco IOS Release 12.2(28)SB, see the release notes at the following URL:
<http://www.cisco.com/univercd/cc/td/doc/product/software/ios122sb/122sbrln/122sbrln.htm>

- The 12.2SR Cisco IOS release train consists of the Cisco 7600 series.
- The 12.2SX Cisco IOS release train consists of the Cisco Catalyst 6500. Before the 12.2SR Cisco IOS release train, the 12.2SX release train also included the Cisco 7600 series.
- IPv6 is also supported in some special software release trains.

Cisco IOS IPv6 Features and Supported Software Releases

Table 3 lists the IPv6 features supported in the 12.0S, 12.xT, 12.2S, 12.2SB, 12.2SRA, 12.3, and 12.4 Cisco IOS software release trains.



Note Table 3 identifies the earliest release for each software release train in which the feature became available. Unless noted otherwise in Table 3, subsequent releases of that Cisco IOS software release train also support that feature.

Table 3 Supported IPv6 Feature

Feature	Where Documented	12.0S Release	12.xT Release	12.3 Release	12.4 Release	12.2S Release	12.2SB Release	12.2SRA Release
IPv6		12.0(22)S	12.2(2)T	12.3	12.4	12.2(14)S	12.2(28)SB	12.2(33)SRA
IPv6 address types: Unicast	Implementing IPv6 Addressing and Basic Connectivity	12.0(22)S	12.2(2)T	12.3	12.4	12.2(14)S	12.2(28)SB	12.2(33)SRA
IPv6: ICMPv6	Implementing IPv6 Addressing and Basic Connectivity	12.0(22)S	12.2(2)T	12.3	12.4	12.2(14)S	12.2(28)SB	12.2(33)SRA
IPv6: IPv6 neighbor discovery	Implementing IPv6 Addressing and Basic Connectivity	12.0(22)S	12.2(2)T	12.3	12.4	12.2(14)S	12.2(28)SB	12.2(33)SRA
IPv6: IPv6 stateless autoconfiguration	Implementing IPv6 Addressing and Basic Connectivity	12.0(22)S	12.2(2)T	12.3	12.4	12.2(14)S	12.2(28)SB	12.2(33)SRA
IPv6: IPv6 MTU path discovery	Implementing IPv6 Addressing and Basic Connectivity	12.0(22)S	12.2(2)T	12.3	12.4	12.2(14)S	12.2(28)SB	12.2(33)SRA

Feature	Where Documented	12.0S Release	12.xT Release	12.3 Release	12.4 Release	12.2S Release	12.2SB Release	12.2SRA Release
IPv6: ICMPv6 redirect	Implementing IPv6 Addressing and Basic Connectivity	12.0(22)S	12.2(4)T	12.3	12.4	12.2(14)S	12.2(28)SB	12.2(33)SRA
IPv6: neighbor discovery duplicate address detection	Implementing IPv6 Addressing and Basic Connectivity	12.0(22)S	12.2(4)T	12.3	12.4	12.2(14)S	12.2(28)SB	12.2(33)SRA
IPv6: IPv6 static cache entry for neighbor discovery	Implementing IPv6 Addressing and Basic Connectivity	12.0(22)S	12.2(8)T	12.3	12.4	12.2(14)S	12.2(28)SB	12.2(33)SRA
IPv6 address types: Anycast	Implementing IPv6 Addressing and Basic Connectivity	—	12.3(4)T	—	12.4	12.2(25)S	12.2(28)SB	12.2(33)SRA
IPv6: NetFlow for IPv6	Implementing NetFlow for IPv6	—	12.3(7)T	—	12.4	—	—	—
IPv6: Mobile IPv6 home agent	Implementing Mobile IPv6	—	12.3(14)T	—	12.4	—	—	—
IPv6: IPv6 default router preferences	Implementing IPv6 Addressing and Basic Connectivity	—	12.4(2)T	—	—	—	—	12.2(33)SRA
IPv6: IPv6 ACL extensions for Mobile IPv6	Implementing Mobile IPv6	—	12.4(2)T	—	—	—	—	—
IPv6: IP Receive ACL for IPv6 traffic	IP Receive ACL	12.0(32)S	—	—	—	—	—	—
IPv6: syslog over IPv6	Implementing IPv6 Addressing and Basic Connectivity	—	12.4(4)T	—	—	—	—	—
IPv6 Switching Services								
IPv6 switching: automatic 6to4 tunnels	Implementing Tunneling for IPv6	12.0(22)S ¹	12.2(2)T	12.3	12.4	12.2(14)S	12.2(28)SB	12.2(33)SRA
IPv6 switching: CEF/dCEF support	Implementing IPv6 Addressing and Basic Connectivity	12.0(22)S	12.2(13)T	12.3	12.4	12.2(14)S	12.2(28)SB	12.2(33)SRA
IPv6 switching: CEFv6 switched configured IPv6 over IPv4 tunnels	Implementing Tunneling for IPv6	—	12.2(13)T	—	12.4	12.2(14)S	12.2(28)SB	12.2(33)SRA
IPv6 switching: provider edge router over MPLS (6PE) ^{2 3}	Implementing IPv6 over MPLS	12.0(22)S	12.2(15)T	12.3	12.4	12.2(14)S	12.2(28)SB	12.2(33)SRA
IPv6 switching: CEFv6 switched ISATAP tunnels	Implementing Tunneling for IPv6	—	12.3(2)T	—	12.4	12.2(14)S	12.2(28)SB	12.2(33)SRA

Feature	Where Documented	12.0S Release	12.xT Release	12.3 Release	12.4 Release	12.2S Release	12.2SB Release	12.2SRA Release
IPv6 switching: CEFv6 switched automatic IPv4-compatible tunnels	Implementing Tunneling for IPv6	—	12.3(2)T	—	12.4	12.2(14)S	12.2(28)SB	12.2(33)SRA
IPv6 Routing								
IPv6 routing: RIP for IPv6 (RIPng)	Implementing RIP for IPv6	12.0(22)S	12.2(2)T ⁴	12.3	12.4	12.2(14)S	12.2(28)SB	12.2(33)SRA
IPv6 routing: static routing	Implementing Static Routes for IPv6	12.0(22)S	12.2(2)T	12.3	12.4	12.2(14)S	12.2(28)SB	12.2(33)SRA
IPv6 routing: route redistribution	Implementing IS-IS for IPv6, Implementing RIP for IPv6	12.0(22)S	12.2(2)T	12.3	12.4	12.2(14)S	12.2(28)SB	12.2(33)SRA
IPv6 routing: multiprotocol BGP extensions for IPv6	Implementing Multiprotocol BGP for IPv6	12.0(22)S	12.2(2)T ⁵	12.3	12.4	12.2(14)S	12.2(28)SB	12.2(33)SRA
IPv6 routing: multiprotocol BGP link-local address peering	Implementing Multiprotocol BGP for IPv6	12.0(22)S	12.2(4)T	12.3	12.4	12.2(14)S	12.2(28)SB	12.2(33)SRA
IPv6 routing: IS-IS support for IPv6	Implementing IS-IS for IPv6	12.0(22)S	12.2(8)T	12.3	12.4	12.2(14)S	12.2(28)SB	12.2(33)SRA
IPv6 routing: IS-IS multitopology support for IPv6	Implementing IS-IS for IPv6	12.0(26)S	12.2(15)T	12.3	12.4	12.2(18)S	12.2(28)SB	12.2(33)SRA
IPv6 routing: OSPF for IPv6 (OSPFv3)	Implementing OSPF for IPv6	12.0(24)S	12.2(15)T	12.3	12.4	12.2(18)S	12.2(28)SB	12.2(33)SRA
IPv6 routing: OSPF for IPv6 authentication support with IPsec	Implementing OSPF for IPv6	—	12.3(4)T	—	12.4	—	—	—
IPv6 Routing: OSPF IPv6 (OSPFv3) IPsec ESP Encryption and Authentication	Implementing OSPF for IPv6	—	12.4(9)T	—	—	—	—	—
IPv6 routing: IPv6 policy-based routing	Implementing Policy-Based Routing for IPv6	—	12.3(7)T	—	12.4	12.2(30)S	—	—
IPv6 routing: EIGRP support	Implementing EIGRP for IPv6	—	12.4(6)T	—	—	—	—	—
IPv6 Services and Management								

Feature	Where Documented	12.0S Release	12.xT Release	12.3 Release	12.4 Release	12.2S Release	12.2SB Release	12.2SRA Release
IPv6 services: AAAA DNS lookups over an IPv4 transport	Implementing IPv6 Addressing and Basic Connectivity	12.0(22)S	12.2(2)T	12.3	12.4	12.2(14)S	12.2(28)SB	12.2(33)SRA
IPv6 services: standard access control lists	Implementing Traffic Filters and Firewalls for IPv6 Security	12.0(22)S	12.2(2)T	12.3	12.4	12.2(14)S	12.2(28)SB	12.2(33)SRA
IPv6 services: DNS lookups over an IPv6 transport	Implementing IPv6 Addressing and Basic Connectivity	12.0(22)S	12.2(8)T	12.3	12.4	12.2(14)S	12.2(28)SB	12.2(33)SRA
IPv6 services: Secure Shell support over IPv6	Managing Cisco IOS Applications over IPv6	12.0(22)S	12.2(8)T	12.3	12.4	12.2(14)S	12.2(28)SB	12.2(33)SRA
IPv6 services: Cisco Discovery Protocol—IPv6 address family support for neighbor information	Implementing IPv6 Addressing and Basic Connectivity	—	12.2(8)T	12.3	12.4	12.2(14)S	12.2(28)SB	12.2(33)SRA
IPv6 services: CISCO-IP-MIB support	Implementing IPv6 Addressing and Basic Connectivity	12.0(22)S	12.2(15)T	12.3	12.4	12.2(14)S	12.2(28)SB	12.2(33)SRA
IPv6 services: CISCO-IP-FORWARDING-MIB support	Implementing IPv6 Addressing and Basic Connectivity	12.0(22)S	12.2(15)T	12.3	12.4	12.2(14)S	12.2(28)SB	12.2(33)SRA
IPv6 services: extended access control lists ³	Implementing Traffic Filters and Firewalls for IPv6 Security	12.0(23)S	12.2(13)T	12.3	12.4	12.2(14)S	12.2(28)SB	12.2(33)SRA
IPv6 services: generic prefix	Implementing IPv6 Addressing and Basic Connectivity	—	12.3(4)T	—	12.4	—	—	—
IPv6 services: SNMP over IPv6 ⁶	Managing Cisco IOS Applications over IPv6	12.0(27)S	12.3(14)T	—	12.4	—	—	—
IPv6 services: IPv6 IOS Firewall	Implementing Traffic Filters and Firewalls for IPv6 Security	—	12.3(7)T	—	12.4	—	—	—
IPv6 services: IPv6 IOS Firewall FTP application support	Implementing Traffic Filters and Firewalls for IPv6 Security	—	12.3(11)T	—	12.4	—	—	—
IPv6 services: IPv6 IPsec VPN	Implementing IPsec in IPv6 Security	—	12.4(4)T	—	—	—	—	—

Feature	Where Documented	12.0S Release	12.xT Release	12.3 Release	12.4 Release	12.2S Release	12.2SB Release	12.2SRA Release
IPv6 services: HSRP for IPv6	Implementing IPv6 Addressing and Basic Connectivity	—	12.4(4)T	—	—	—	—	—
IPv6 services: FHRP - GLBP for IPv6	Implementing GLBP for IPv6	—	12.4(6)T	—	—	—	—	—
IPv6 Broadband Access								
IPv6 access services: PPPoA	Implementing ADSL and Deploying Dial Access for IPv6	—	12.2(13)T	12.3	12.4	—	—	—
IPv6 access services: PPPoE	Implementing ADSL and Deploying Dial Access for IPv6	—	12.2(13)T	12.3	12.4	—	—	—
IPv6 access services: prefix pools	Implementing ADSL and Deploying Dial Access for IPv6	—	12.2(13)T	12.3	12.4	—	—	—
IPv6 access services: AAA support for Cisco VSA IPv6 attributes	Implementing ADSL and Deploying Dial Access for IPv6	—	12.2(13)T	12.3	12.4	—	—	—
IPv6 access services: remote bridged encapsulation	Implementing IPv6 Addressing and Basic Connectivity	—	12.3(4)T	—	12.4	—	—	—
IPv6 access services: AAA support for RFC 3162 IPv6 RADIUS attributes	Implementing ADSL and Deploying Dial Access for IPv6	—	12.3(4)T	—	12.4	—	—	—
IPv6 access services: stateless DHCPv6	Implementing DHCP for IPv6	12.0(32)S ⁷	12.3(4)T	—	12.4	—	12.2(28)SB	—
IPv6 access services: DHCPv6 prefix delegation	Implementing DHCP for IPv6, Implementing ADSL and Deploying Dial Access for IPv6	12.0(32)S ⁷	12.3(4)T	—	12.4	12.2(18)SXE ⁸	12.2(28)SB	12.2(33)SRA
IPv6 access services: DHCP for IPv6 relay agent	Implementing DHCP for IPv6	—	12.3(11)T	—	12.4	—	12.2(28)SB	—
IPv6 access services: DHCPv6 prefix delegation via AAA	Implementing ADSL and Deploying Dial Access for IPv6	—	12.3(14)T	—	12.4	—	12.2(28)SB	—
IPv6 Multicast		12.0(26)S ⁹	12.3(2)T	—	12.4	12.2(18)S	12.2(28)SB	12.2(33)SRA

Feature	Where Documented	12.0S Release	12.xT Release	12.3 Release	12.4 Release	12.2S Release	12.2SB Release	12.2SRA Release
IPv6 multicast: Multicast Listener Discovery (MLD) protocol, versions 1 and 2	Implementing IPv6 Multicast	12.0(26)S ⁹	12.3(2)T	—	12.4	12.2(18)S	12.2(28)SB	12.2(33)SRA
IPv6 multicast: PIM sparse mode (PIM-SM)	Implementing IPv6 Multicast	12.0(26)S ⁹	12.3(2)T	—	12.4	12.2(18)S	12.2(28)SB	12.2(33)SRA
IPv6 multicast: PIM Source Specific Multicast (PIM-SSM)	Implementing IPv6 Multicast	12.0(26)S ⁹	12.3(2)T	—	12.4	12.2(18)S	12.2(28)SB	12.2(33)SRA
IPv6 multicast: scope boundaries	Implementing IPv6 Multicast	12.0(26)S ⁹	12.3(2)T	—	12.4	12.2(18)S	12.2(28)SB	12.2(33)SRA
IPv6 multicast: MLD access group	Implementing IPv6 Multicast	12.0(26)S ⁹	12.3(4)T	—	12.4	12.2(25)S	12.2(28)SB	12.2(33)SRA
IPv6 multicast: PIM accept register	Implementing IPv6 Multicast	12.0(26)S ⁹	12.3(4)T	—	12.4	12.2(25)S	12.2(28)SB	12.2(33)SRA
IPv6 multicast: PIM embedded RP support	Implementing IPv6 Multicast	12.0(26)S ⁹	12.3(4)T	—	12.4	12.2(25)S	12.2(28)SB	12.2(33)SRA
IPv6 multicast: RPF flooding of bootstrap router (BSR) packets	Implementing IPv6 Multicast	12.0(26)S ⁹	12.3(4)T	—	12.4	12.2(25)S	12.2(28)SB	12.2(33)SRA
IPv6 multicast: routable address hello option	Implementing IPv6 Multicast	12.0(26)S ⁹	12.3(4)T	—	12.4	12.2(25)S	12.2(28)SB	12.2(33)SRA
IPv6 multicast: static multicast routing (mroute)	Implementing IPv6 Multicast	12.0(26)S ⁹	12.3(4)T	—	12.4	12.2(25)S	12.2(28)SB	12.2(33)SRA
IPv6 multicast: address family support for multiprotocol Border Gateway Protocol (MBGP)	Implementing IPv6 Multicast	12.0(26)S ⁹	12.3(4)T	—	12.4	12.2(25)S	12.2(28)SB	12.2(33)SRA
IPv6 multicast: Explicit tracking of receivers	Implementing IPv6 Multicast	—	12.3(7)T	—	12.4	12.2(25)S	12.2(28)SB	12.2(33)SRA
IPv6 multicast: IPv6 bidirectional PIM	Implementing IPv6 Multicast	—	12.3(7)T	—	12.4	12.2(25)S	12.2(28)SB	12.2(33)SRA
IPv6 multicast: MFIB display enhancements	Implementing IPv6 Multicast	—	12.3(7)T	—	12.4	—	—	—

Feature	Where Documented	12.0S Release	12.xT Release	12.3 Release	12.4 Release	12.2S Release	12.2SB Release	12.2SRA Release
IPv6 multicast: IPv6 BSR	Implementing IPv6 Multicast	12.0(28)S	12.3(11)T	—	12.4	12.2(25)S	12.2(28)SB	12.2(33)SRA
IPv6 multicast: IPv6 BSR bidirectional support	Implementing IPv6 Multicast	—	12.3(14)T	—	12.4	—	—	—
IPv6 multicast: IPv6 BSR scoped-zone support	Implementing IPv6 Multicast	—	—	—	—	12.2(18)SXE ⁸	—	—
IPv6 multicast: SSM mapping for MLDv1 SSM	Implementing IPv6 Multicast	—	12.4(2)T	—	—	12.2(18)SXE ⁸	—	12.2(33)SRA
IPv6 multicast: IPv6 BSR—ability to configure RP mapping	Implementing IPv6 Multicast	—	12.4(2)T	—	—	—	—	—
IPv6 multicast: MLD group limits	Implementing IPv6 Multicast	—	12.4(2)T	—	—	—	—	—
IPv6 multicast: multicast user authentication and profile support	Implementing IPv6 Multicast	—	12.4(4)T	—	—	—	—	—
NAT Protocol Translation (NAT-PT)		—	12.2(13)T	12.3	12.4	—	—	—
NAT-PT: support for DNS ALG	Implementing NAT Protocol Translation	—	12.2(13)T	12.3	12.4	—	—	—
NAT-PT: support for overload	Implementing NAT Protocol Translation	—	12.3(2)T	—	12.4	—	—	—
NAT-PT: support for FTP ALG	Implementing NAT Protocol Translation	—	12.3(2)T	—	12.4	—	—	—
NAT-PT: support for fragmentation	Implementing NAT Protocol Translation	—	12.3(2)T	—	12.4	—	—	—
NAT-PT: support for translations in CEF switching	Implementing NAT Protocol Translation	—	12.3(14)T	—	12.4	—	—	—
IPv6 Tunnel Services								
IPv6 tunneling: manually configured IPv6 over IPv4 tunnels	Implementing Tunneling for IPv6	12.0(23)S ¹	12.2(2)T	12.3	12.4	12.2(14)S	12.2(28)SB	12.2(33)SRA
IPv6 tunneling: automatic 6to4 tunnels	Implementing Tunneling for IPv6	12.0(22)S ¹	12.2(2)T	12.3	12.4	12.2(14)S	12.2(28)SB	12.2(33)SRA

Feature	Where Documented	12.0S Release	12.xT Release	12.3 Release	12.4 Release	12.2S Release	12.2SB Release	12.2SRA Release
IPv6 tunneling: automatic IPv4-compatible tunnels	Implementing Tunneling for IPv6	12.0(22)S	12.2(2)T	12.3	12.4	12.2(14)S	12.2(28)SB	12.2(33)SRA
IPv6 tunneling: IPv6 over IPv4 GRE tunnels	Implementing Tunneling for IPv6	12.0(22)S ¹⁰	12.2(4)T	12.3	12.4	12.2(14)S	12.2(28)SB	12.2(33)SRA
IPv6 tunneling: IPv6 over UTI using a tunnel line card ¹¹	Implementing Tunneling for IPv6	12.0(23)S	—	—	—	—	—	—
IPv6 tunneling: ISATAP tunnel support	Implementing Tunneling for IPv6	—	12.2(15)T	12.3	12.4	12.2(14)S	12.2(28)SB	12.2(33)SRA
IPv6 tunneling: IPv4 over IPv6 tunnels	Implementing Tunneling for IPv6	—	12.3(7)T	—	12.4	12.2(30)S	—	12.2(33)SRA
IPv6 tunneling: IPv6 over IPv6 tunnels	Implementing Tunneling for IPv6	—	12.3(7)T	—	12.4	12.2(30)S	—	12.2(33)SRA
IPv6 tunneling: IP over IPv6 GRE tunnels	Implementing Tunneling for IPv6	—	12.3(7)T	—	12.4	12.2(30)S	—	12.2(33)SRA
IPv6 tunneling: IPv6 GRE tunnels in CLNS networks	Implementing Tunneling for IPv6	—	12.3(7)T	—	12.4	12.2(25)S	12.2(28)SB	12.2(33)SRA
IPv6 QoS (Quality of Service)		12.0(28)S ¹²	12.2(13)T	12.3	12.4	12.2(18)SXE ⁸	—	12.2(33)SRA
IPv6 QoS: MQC packet classification	Implementing QoS for IPv6 for Cisco IOS Software	—	12.2(13)T	12.3	12.4	12.2(18)SXE ⁸	—	12.2(33)SRA
IPv6 QoS: MQC traffic shaping	Implementing QoS for IPv6 for Cisco IOS Software	12.0(28)S ¹²	12.2(13)T	12.3	12.4	12.2(18)SXE ⁸	—	12.2(33)SRA
IPv6 QoS: MQC traffic policing	Implementing QoS for IPv6 for Cisco IOS Software	12.0(28)S ¹²	12.2(13)T	12.3	12.4	12.2(18)SXE ⁸	—	12.2(33)SRA
IPv6 QoS: MQC packet marking/re-marking	Implementing QoS for IPv6 for Cisco IOS Software	12.0(28)S ¹²	12.2(13)T	12.3	12.4	12.2(18)SXE ⁸	—	12.2(33)SRA
IPv6 QoS: queueing	Implementing QoS for IPv6 for Cisco IOS Software	—	12.2(13)T	12.3	12.4	12.2(18)SXE ⁸	—	12.2(33)SRA
IPv6 QoS: MQC weighted random early detection (WRED)-based drop	Implementing QoS for IPv6 for Cisco IOS Software	12.0(28)S ¹²	12.2(13)T	12.3	12.4	12.2(18)SXE ⁸	—	12.2(33)SRA

Feature	Where Documented	12.0S Release	12.xT Release	12.3 Release	12.4 Release	12.2S Release	12.2SB Release	12.2SRA Release
IPv6 Data Link Layer								
IPv6 data link: ATM PVC and ATM LANE	Implementing IPv6 Addressing and Basic Connectivity	12.0(22)S ¹³	12.2(2)T	12.3	12.4	12.2(14)S	12.2(28)SB	12.2(33)SRA
IPv6 data link: Ethernet, Fast Ethernet, Gigabit Ethernet, and 10-Gigabit Ethernet	Implementing IPv6 Addressing and Basic Connectivity	12.0(22)S	12.2(2)T	12.3	12.4	12.2(14)S	12.2(28)SB	12.2(33)SRA
IPv6 data link: FDDI	Implementing IPv6 Addressing and Basic Connectivity	—	12.2(2)T	12.3	12.4	12.2(14)S	12.2(28)SB	12.2(33)SRA
IPv6 data link: Frame Relay PVC ¹⁴	Implementing IPv6 Addressing and Basic Connectivity	12.0(22)S	12.2(2)T	12.3	12.4	12.2(14)S	12.2(28)SB	12.2(33)SRA
IPv6 data link: Cisco High-Level Data Link Control	Implementing IPv6 Addressing and Basic Connectivity	12.0(22)S	12.2(2)T	12.3	12.4	12.2(14)S	12.2(28)SB	12.2(33)SRA
IPv6 data link: PPP service over packet over SONET, ISDN, and serial (synchronous and asynchronous) interfaces	Implementing IPv6 Addressing and Basic Connectivity	12.0(22)S	12.2(2)T	12.3	12.4	12.2(14)S	12.2(28)SB	12.2(33)SRA
IPv6 data link: VLANs using IEEE 802.1Q encapsulation	Implementing IPv6 Addressing and Basic Connectivity	12.0(22)S	12.2(2)T	12.3	12.4	12.2(14)S	12.2(28)SB	12.2(33)SRA
IPv6 data link: VLANs using Cisco Inter-Switch Link (ISL)	Implementing IPv6 Addressing and Basic Connectivity	12.0(22)S	12.2(2)T	12.3	12.4	12.2(14)S	12.2(28)SB	12.2(33)SRA
IPv6 data link: dynamic packet transport (DPT)	Implementing IPv6 Addressing and Basic Connectivity	12.0(23)S	—	—	—	—	—	—

1. In Cisco IOS Release 12.0(23)S, the Cisco 12000 series Internet router provides enhanced performance for IPv6 manually configured tunnels by processing traffic on the line card.
2. The Cisco 10720 Internet router is supported in Cisco IOS Release 12.0(26)S.
3. IPv6 extended access control lists and IPv6 provider edge routers over MPLS are implemented with IPv6 hardware acceleration on the Cisco 12000 series Internet router IP service engine (ISE) line cards in Cisco IOS routers in Cisco IOS Release 12.0(25)S and later releases.
4. The RIP for IPv6 feature was updated in Cisco IOS Release 12.2(13)T.
5. Enhancements were made to several multiprotocol BGP commands.
6. SNMP versions 1, 2, and 3 are supported over an IPv6 transport.
7. In Cisco IOS Release 12.0(32)S, the Dynamic Host Configuration Protocol (DHCP) for IPv6 prefix delegation is supported on shared port adaptors (SPAs) in the 10G Engine 5 SPA Interface Processor (SIP) on the Cisco 12000 series Internet router only for stateless address assignment.

8. Cisco IOS Release 12.2(18)SXE provides support for this feature. Cisco IOS Release 12.2(18)SXE is specific to Cisco Catalyst 6500 and Cisco 7600 series routers.
9. Feature is supported on Cisco 12000 series Internet routers in Cisco IOS Release 12.0(26)S.
10. IPv6 over IPv4 GRE tunnels are not supported on the Cisco 12000 series Internet router.
11. Feature is supported on the Cisco 12000 series Internet router only.
12. Feature is supported on Cisco 12000 series Internet routers in Cisco IOS Release 12.0(28)S.
13. Only ATM PVCs are supported in the Cisco IOS 12.0S software release train; ATM LANE is not supported.
14. Frame Relay PVCs are not supported by distributed CEF switching for IPv6 in the 12.0S Cisco IOS software train. In the Cisco 12000 series Internet routers, Frame Relay encapsulated IPv6 packets are process switched on the Route Processor.

Cisco Platforms Supporting IPv6 Hardware Forwarding

Finding Support Information for Platforms and Cisco IOS Software Images

Use Cisco Feature Navigator to find information about platform support and Cisco IOS software image support. Access Cisco Feature Navigator at <http://www.cisco.com/go/fn>. You must have an account on Cisco.com. If you do not have an account or have forgotten your username or password, click **Cancel** at the login dialog box and follow the instructions that appear.

Supported Platforms

Table 4 lists the Cisco platforms that have IPv6 hardware forwarding and the Cisco IOS software release trains that introduce the feature.



Note

Table 4 lists only the Cisco IOS software release that introduced support for a given feature in a given Cisco IOS software release train. Unless noted otherwise in Table 4, subsequent releases of that Cisco IOS software release train also support that feature.

Table 4 Minimum Required Release for Cisco Platforms Supporting IPv6 Hardware Forwarding

Hardware and Feature	Cisco IOS Software Release
Cisco 12000 Series	
IP ISE line card IPv6 forwarding	12.0(23)S
IP ISE line card extended ACLs	12.0(25)S
IP ISE line card IPv6 over MPLS (6PE)	12.0(25)S
IP ISE line card IPv6 Multicast assist	12.0(26)S
IP ISE line card IPv6 QoS	12.0(28)S
Engine 5 line card IPv6 hardware forwarding	12.0(31)S
IP Receive ACL for IPv6 traffic	12.0(32)S
Cisco 10720 Series	
Performance Routing Engine 2 (PRE-2) hardware forwarding	12.2(28)SB
PxF accelerated for IPv6 forwarding	12.0(26)S, 12.2(28)SB
PxF accelerated for IPv6 extended ACLs	12.0(26)S

Hardware and Feature	Cisco IOS Software Release
PxF accelerated for IPv6 over MPLS (6PE)	12.0(26)S
Cisco Catalyst 6500, Cisco Catalyst 3500, Cisco Catalyst 3700, and Cisco 7600 series	
Supervisor Engine 720 IPv6 forwarding	12.2(17a)SX1
Supervisor Engine 720 IPv6 extended ACLs	12.2(17a)SX1
Supervisor Engine 720 IPv6 over MPLS (6PE)	12.2(17b)SXA
Supervisor Engine 720 IPv6 multicast hardware forwarding	12.2(18)SXE
Supervisor Engine 32/MSFC2A	12.2(18)SXF
Cisco Catalyst 3560 series	12.2(25)SEA
Cisco Catalyst 3750 series	12.2(25)SEA
Supervisor Engines 720 and 720-3bx1	12.2(33)SRA

Additional 12.2S Release Trains

Several early-deployment Cisco IOS software Release 12.2S trains synchronize to the Cisco IOS software mainline Release 12.2S train. The following table lists information about the release trains on which IPv6 hardware is used.

Table 5 Minimum Required Release for IPv6 Hardware on Early-Deployment 12.2S Cisco IOS Software Release Trains

Early-Deployment Cisco IOS Software Release and Hardware	Release Description
12.2SX on Cisco Catalyst 6500	12.2(17)SX includes the entire Cisco IOS software Release 12.2(14)S feature set, plus OSPFv3.
12.2SX on Cisco 7600 series	12.2(17)SX includes the entire Cisco IOS software Release 12.2(14)S feature set, plus OSPFv3.
12.2(18)SXE on Cisco Catalyst 6500 and Cisco 7600 series	12.2(18)SXE supports IPv6 multicast hardware forwarding.
12.2(18)SXF on Supervisor Engine 32/MSFC2A	
12.2SG ¹ on Cisco Catalyst 4500	12.2SG includes the entire Cisco IOS software Release 12.2(18)S IPv6 feature set.
12.2(17d)SXB on Cisco Catalyst 6500 Supervisor Engine 2/MSFC2	IPv6 support provided on 12.2(17)SXB for Cisco Catalyst 6500 Supervisor Engine 2/MSFC2.
12.2(25)SEA on Cisco Catalyst 3560 and 3570 series	12.2(25)SEA supports a subset of the 12.2S IPv6 feature set. IPv6 multicast is not supported.
12.2(28)SB on Cisco 10000 series	Not all features for Cisco IOS Release 12.2(28)SB are supported on the Cisco 10000 series routers. For further information on Cisco IOS Release 12.2(28)SB, see the release notes at the following URL: http://www.cisco.com/univercd/cc/td/doc/product/software/ios122sb/122sbrln/122sbrln.htm
12.2(33)SRA on Cisco 7600 series	12.2(33)SRA includes all IPv6 features from Cisco IOS software releases 12.2S and 12.2SX.

1. This release was originally Cisco IOS Release 12.2(20)EW.

Supported RFCs

- RFC 1886, *DNS Extensions to Support IP version 6*
- RFC 1981, *Path MTU Discovery for IP version 6*
- RFC 2080, *RIPng for IPv6*
- RFC 2375, *IPv6 Multicast Address Assignments*
- RFC 2401, *Security Architecture for the Internet Protocol*
- RFC 2402, *IP Authentication Header*
- RFC 2404, *The Use of Hash Message Authentication Code Federal Information Processing Standard 180-1 within Encapsulating Security Payload and Authentication Header*
- RFC 2406, *IP Encapsulating Security Payload (ESP)*
- RFC 2407, *The Internet Security Domain of Interpretation for ISAKMP*
- RFC 2408, *Internet Security Association and Key Management Protocol*
- RFC 2409, *Internet Key Exchange (IKE)*
- RFC 2460, *Internet Protocol, Version 6 (IPv6) Specification*
- RFC 2461, *Neighbor Discovery for IP Version 6 (IPv6)*
- RFC 2462, *IPv6 Stateless Address Autoconfiguration*
- RFC 2463, *Internet Control Message Protocol (ICMPv6) for the Internet Protocol Version 6 (IPv6) Specification*
- RFC 2464, *Transmission of IPv6 Packets over Ethernet Networks*
- RFC 2467, *Transmission of IPv6 Packets over FDDI Networks*
- RFC 2472, *IP Version 6 over PPP*
- RFC 2474, *Definition of the Differentiated Services Field (DS Field) in the IPv4 and IPv6 Headers*
- RFC 2475, *An Architecture for Differentiated Services Framework*
- RFC 2492, *IPv6 over ATM Networks*
- RFC 2545, *Use of BGP-4 Multiprotocol Extensions for IPv6 Inter-Domain Routing*
- RFC 2590, *Transmission of IPv6 Packets over Frame Relay Networks Specification*
- RFC 2597, *Assured Forwarding PHB*
- RFC 2598, *An Expedited Forwarding PHB*
- RFC 2697, *A Single Rate Three Color Marker*
- RFC 2698, *A Two Rate Three Color Marker*
- RFC 2710, *Multicast Listener Discovery (MLD) for IPv6*
- RFC 2740, *OSPF for IPv6*
- RFC 2766, *Network Address Translation–Protocol Translation (NAT-PT)*
- RFC 2858, *Multiprotocol Extensions for BGP-4*
- RFC 2893, *Transition Mechanisms for IPv6 Hosts and Routers*
- RFC 3056, *Connection of IPv6 Domains via IPv4 Clouds*
- RFC 3068, *An Anycast Prefix for 6to4 Relay Routers*

- RFC 3147, *Generic Routing Encapsulation over CLNS Networks*
- RFC 3162, *RADIUS and IPv6*
- RFC 3315, *Dynamic Host Configuration Protocol for IPv6 (DHCPv6)*
- RFC 3319, *Dynamic Host Configuration Protocol (DHCPv6) Options for Session Initiated Protocol (SIP) Servers*
- RFC 3484, *Default Address Selection for Internet Protocol version 6 (IPv6)*
- RFC 3576, *Change of Authorization*
- RFC 3587, *IPv6 Global Unicast Address Format*
- RFC 3633, *DHCP IPv6 Prefix Delegation*
- RFC 3646, *DNS Configuration options for Dynamic Host Configuration Protocol for IPv6 (DHCPv6)*
- RFC 3736, *Stateless DHCP Service for IPv6*
- RFC 3775, *Mobility Support in IPv6*
- RFC 3810, *Multicast Listener Discovery Version 2 (MLDv2) for IPv6*, June 2003
- RFC 3954, *Cisco Systems NetFlow Services Export Version 9*
- RFC 3956, *Embedding the Rendezvous Point (RP) Address in an IPv6 Multicast Address*
- RFC 4007, *IPv6 Scoped Address Architecture*
- RFC 4191, *Default Router Preferences and More-Specific Routes*
- RFC 4193, *Unique Local IPv6 Unicast Addresses*
- RFC 4214, *Intra-Site Automatic Tunnel Addressing Protocol (ISATAP)*
- RFC 4291, *IP Version 6 Addressing Architecture*
- RFC 4443, *Internet Control Message Protocol (ICMPv6) for the Internet Protocol Version 6 (IPv6) Specification*

The draft RFCs supported are as follows:

- draft-ietf-isis-ipv6, *Routing IPv6 with IS-IS*
- draft-ietf-isis-wg-multi-topology, *M-ISIS: Multi-Topology (MT) Routing in IS-IS*
- draft-ietf-pim-sm-v2-new, *Protocol Independent Multicast - Sparse Mode PIM-SM: Protocol Specification (Revised)*, March 6, 2003
- draft-ietf-ospf-ospfv3-auth-03, *Authentication/Confidentiality for OSPFv3*, July 2003
- draft-ietf-pim-sm-bsr-03.txt, *Bootstrap Router (BSR) Mechanism for PIM Sparse Mode*, February 25, 2003
- draft-oops-v6ops-bgp-tunnel, *Connecting IPv6 Islands over IPv4 MPLS using IPv6 Provider Edge Routers (6PE)*
- draft-suz-pim-upstream-detection, *PIM Upstream Detection Among Multiple Addresses*, February 2003

MIBs

MIBs	MIBs Link
<ul style="list-style-type: none">• CISCO-CONFIG-COPY-MIB• CISCO-DATA-COLLECTION-MIB• CISCO-FLASH-MIB• CISCO-IETF-IP-FORWARD-MIB• CISCO-IETF-IP-MIB• ENTITY-MIB• NOTIFICATION-LOG-MIB• SNMP-TARGET-MIB	<p>To obtain lists of supported MIBs by platform and Cisco IOS release, and to download MIB modules, go to the Cisco MIB website on Cisco.com at the following URL:</p> <p>http://www.cisco.com/public/sw-center/netmgmt/cmtk/mibs.shtml</p>

Related Documents

- Refer to the configuration guide and command reference publications at the following website on Cisco.com for IPv4 configuration and command reference information:
<http://www.cisco.com/univercd/cc/td/doc/product/software/ios124cg/index.htm>
- Refer to the release notes at the following website for the specific release information:
<http://www.cisco.com/univercd/cc/td/doc/product/software/ios124/124relnt/index.htm>
- Refer to the following website on Cisco.com for more information on the Cisco implementation of and training for IPv6:
<http://www.cisco.com/warp/public/732/Tech/ipv6/>
- Refer to the IPv6 integration solutions documents (ISDs) at the following website on Cisco.com for information that will help you deploy IPv6 in your network:
http://www.cisco.com/univercd/cc/td/doc/solution/ip_sol/index.htm



Implementing IPv6 Addressing and Basic Connectivity

First Published: June 26, 2006

Last Updated: June 26, 2006

Implementing basic IPv6 connectivity in the Cisco IOS software consists of assigning IPv6 addresses to individual router interfaces. The forwarding of IPv6 traffic can be enabled globally, and Cisco Express Forwarding switching for IPv6 can also be enabled. Basic connectivity can be enhanced by configuring support for AAAA record types in the Domain Name System (DNS) name-to-address and address-to-name lookup processes, and by managing IPv6 neighbor discovery.

The *Implementing IPv6 Addressing and Basic Connectivity* module describes IPv6 addressing and basic IPv6 connectivity tasks.

Finding Feature Information in This Module

Your Cisco IOS software release may not support all of the features documented in this module. To reach links to specific feature documentation in this module and to see a list of the releases in which each feature is supported, use the “[Feature Information for Implementing IPv6 Addressing and Basic Connectivity](#)” section on page 81 or the *Start Here: Cisco IOS Software Release Specifics for IPv6 Features* in the *Cisco IOS IPv6 Configuration Library*.

Finding Support Information for Platforms and Cisco IOS and Catalyst OS Software Images

Use Cisco Feature Navigator to find information about platform support and Cisco IOS and Catalyst OS software image support. To access Cisco Feature Navigator, go to <http://www.cisco.com/go/cfn>. An account on Cisco.com is not required.

Contents

- [Prerequisites for Implementing IPv6 Addressing and Basic Connectivity](#), page 18
- [Restrictions for Implementing IPv6 Addressing and Basic Connectivity](#), page 18
- [Information About Implementing IPv6 Addressing and Basic Connectivity](#), page 19
- [How to Implement IPv6 Addressing and Basic Connectivity](#), page 45
- [Configuration Examples for Implementing IPv6 Addressing and Basic Connectivity](#), page 72
- [Where to Go Next](#), page 78

- [Additional References](#), page 78
- [Feature Information for Implementing IPv6 Addressing and Basic Connectivity](#), page 81

Prerequisites for Implementing IPv6 Addressing and Basic Connectivity

- This document assumes that you are familiar with IPv4. See the publications shown in the “[Additional References](#)” section for IPv4 configuration and command reference information.
- The following prerequisites apply to Cisco Express Forwarding and distributed Cisco Express Forwarding for IPv6:
 - To forward IPv6 traffic using Cisco Express Forwarding or distributed Cisco Express Forwarding, you must configure forwarding of IPv6 unicast datagrams globally on the router by using the **ipv6 unicast-routing** command, and you must configure an IPv6 address on an interface by using the **ipv6 address** command.
 - You must enable Cisco Express Forwarding for IPv4 globally on the router by using the **ip cef** command before enabling Cisco Express Forwarding for IPv6 globally on the router by using the **ipv6 cef** command.
 - On distributed architecture platforms that support both Cisco Express Forwarding and distributed Cisco Express Forwarding, such as the Cisco 7500 series routers, you must enable distributed Cisco Express Forwarding for IPv4 globally on the router by using the **ip cef distributed** command before enabling distributed Cisco Express Forwarding for IPv6 globally on the router by using the **ipv6 cef distributed** command.



Note

By default, the Cisco 12000 series Internet routers support only distributed Cisco Express Forwarding.

- To use Unicast Reverse Path Forwarding (RPF), enable Cisco Express Forwarding switching or distributed Cisco Express Forwarding switching in the router. There is no need to configure the input interface for Cisco Express Forwarding switching. As long as Cisco Express Forwarding is running on the router, individual interfaces can be configured with other switching modes.



Note

For Unicast RPF to work, Cisco Express Forwarding must be configured globally in the router. Unicast RPF will not work without Cisco Express Forwarding.

Restrictions for Implementing IPv6 Addressing and Basic Connectivity

- In Cisco IOS Release 12.2(11)T or earlier releases, IPv6 supports only process switching for packet forwarding. Cisco Express Forwarding switching and distributed Cisco Express Forwarding switching for IPv6 are supported in Cisco IOS Release 12.2(13)T. Distributed Cisco Express Forwarding switching for IPv6 is supported in Cisco IOS Release 12.0(21)ST.

- IPv6 packets are transparent to Layer 2 LAN switches because the switches do not examine Layer 3 packet information before forwarding IPv6 frames. Therefore, IPv6 hosts can be directly attached to Layer 2 LAN switches.
- In any Cisco IOS release with IPv6 support, multiple IPv6 global and site-local addresses within the same prefix can be configured on an interface. However, multiple IPv6 link-local addresses on an interface are not supported. See the “[IPv6 Addressing and IPv6 Routing Configuration: Example](#)” section for information on configuring multiple IPv6 global and site-local addresses within the same prefix on an interface.

Information About Implementing IPv6 Addressing and Basic Connectivity

To configure IPv6 addressing and basic connectivity for IPv6 for Cisco IOS, you must understand the following concepts:

- [IPv6 for Cisco IOS Software, page 19](#)
- [Large IPv6 Address Space for Unique Addresses, page 20](#)
- [IPv6 Address Formats, page 20](#)
- [IPv6 Address Type: Unicast, page 21](#)
- [IPv6 Address Type: Anycast, page 24](#)
- [IPv6 Address Type: Multicast, page 25](#)
- [IPv6 Address Output Display, page 27](#)
- [Simplified IPv6 Packet Header, page 27](#)
- [Cisco Express Forwarding and distributed Cisco Express Forwarding Switching for IPv6, page 31](#)
- [DNS for IPv6, page 33](#)
- [Path MTU Discovery for IPv6, page 33](#)
- [Cisco Discovery Protocol IPv6 Address Support, page 34](#)
- [ICMP for IPv6, page 34](#)
- [IPv6 Neighbor Discovery, page 34](#)
- [Link, Subnet, and Site Addressing Changes, page 40](#)
- [IPv6 Prefix Aggregation, page 42](#)
- [IPv6 Site Multihoming, page 43](#)
- [IPv6 Data Links, page 43](#)
- [Routed Bridge Encapsulation for IPv6, page 44](#)
- [Dual IPv4 and IPv6 Protocol Stacks, page 44](#)

IPv6 for Cisco IOS Software

IPv6, formerly named IPng (next generation), is the latest version of the Internet Protocol (IP). IP is a packet-based protocol used to exchange data, voice, and video traffic over digital networks. IPv6 was proposed when it became clear that the 32-bit addressing scheme of IP version 4 (IPv4) was inadequate

to meet the demands of Internet growth. After extensive discussion it was decided to base IPng on IP but add a much larger address space and improvements such as a simplified main header and extension headers. IPv6 is described initially in RFC 2460, *Internet Protocol, Version 6 (IPv6) Specification*, issued by the Internet Engineering Task Force (IETF). Further RFCs describe the architecture and services supported by IPv6.

The architecture of IPv6 has been designed to allow existing IPv4 users to transition easily to IPv6 while providing services such as end-to-end security, quality of service (QoS), and globally unique addresses. The larger IPv6 address space allows networks to scale and provide global reachability. The simplified IPv6 packet header format handles packets more efficiently. IPv6 prefix aggregation, simplified network renumbering, and IPv6 site multihoming capabilities provide an IPv6 addressing hierarchy that allows for more efficient routing. IPv6 supports widely deployed routing protocols such as Routing Information Protocol (RIP), Integrated Intermediate System-to-Intermediate System (IS-IS), Open Shortest Path First for IPv6, and multiprotocol Border Gateway Protocol (BGP). Other available features include stateless autoconfiguration, enhanced support for Mobile IPv6, and an increased number of multicast addresses.

Large IPv6 Address Space for Unique Addresses

The primary motivation for IPv6 is the need to meet the anticipated future demand for globally unique IP addresses. Applications such as mobile Internet-enabled devices (such as personal digital assistants [PDAs], telephones, and cars), home-area networks (HANs), and wireless data services are driving the demand for globally unique IP addresses. IPv6 quadruples the number of network address bits from 32 bits (in IPv4) to 128 bits, which provides more than enough globally unique IP addresses for every networked device on the planet. By being globally unique, IPv6 addresses inherently enable global reachability and end-to-end security for networked devices, functionality that is crucial to the applications and services that are driving the demand for the addresses. Additionally, the flexibility of the IPv6 address space reduces the need for private addresses and the use of Network Address Translation (NAT); therefore, IPv6 enables new application protocols that do not require special processing by border routers at the edge of networks.

IPv6 Address Formats

IPv6 addresses are represented as a series of 16-bit hexadecimal fields separated by colons (:) in the format: x:x:x:x:x:x:x:x. Following are two examples of IPv6 addresses:

```
2001:0DB8:7654:3210:FEDC:BA98:7654:3210
```

```
2001:0DB8:0:0:8:800:200C:417A
```

It is common for IPv6 addresses to contain successive hexadecimal fields of zeros. To make IPv6 addresses less cumbersome, two colons (::) may be used to compress successive hexadecimal fields of zeros at the beginning, middle, or end of an IPv6 address (the colons represent successive hexadecimal fields of zeros). [Table 6](#) lists compressed IPv6 address formats.

A double colon may be used as part of the *ipv6-address* argument when consecutive 16-bit values are denoted as zero. You can configure multiple IPv6 addresses per interfaces, but only one link-local address.

**Note**

Two colons (::) can be used only once in an IPv6 address to represent the longest successive hexadecimal fields of zeros.

The hexadecimal letters in IPv6 addresses are not case-sensitive.

Table 6 *Compressed IPv6 Address Formats*

IPv6 Address Type	Preferred Format	Compressed Format
Unicast	2001:0:0:0:0DB8:800:200C:417A	2001::0DB8:800:200C:417A
Multicast	FF01:0:0:0:0:0:101	FF01::101
Loopback	0:0:0:0:0:0:0:1	::1
Unspecified	0:0:0:0:0:0:0:0	::

The loopback address listed in [Table 6](#) may be used by a node to send an IPv6 packet to itself. The loopback address in IPv6 functions the same as the loopback address in IPv4 (127.0.0.1).

**Note**

The IPv6 loopback address cannot be assigned to a physical interface. A packet that has the IPv6 loopback address as its source or destination address must remain within the node that created the packet. IPv6 routers do not forward packets that have the IPv6 loopback address as their source or destination address.

The unspecified address listed in [Table 6](#) indicates the absence of an IPv6 address. For example, a newly initialized node on an IPv6 network may use the unspecified address as the source address in its packets until it receives its IPv6 address.

**Note**

The IPv6 unspecified address cannot be assigned to an interface. The unspecified IPv6 addresses must not be used as destination addresses in IPv6 packets or the IPv6 routing header.

An IPv6 address prefix, in the format *ipv6-prefix/prefix-length*, can be used to represent bit-wise contiguous blocks of the entire address space. The *ipv6-prefix* must be in the form documented in RFC 2373 where the address is specified in hexadecimal using 16-bit values between colons. The prefix length is a decimal value that indicates how many of the high-order contiguous bits of the address comprise the prefix (the network portion of the address). For example, 2001:0DB8:8086:6502::/32 is a valid IPv6 prefix.

IPv6 Address Type: Unicast

An IPv6 unicast address is an identifier for a single interface, on a single node. A packet that is sent to a unicast address is delivered to the interface identified by that address. The Cisco IOS software supports the following IPv6 unicast address types:

- [Aggregatable Global Address, page 22](#)
- [Site-Local Address, page 23](#)
- [Link-Local Address, page 24](#)
- [IPv4-Compatible IPv6 Address, page 24](#)

Aggregatable Global Address

An aggregatable global address is an IPv6 address from the aggregatable global unicast prefix. The structure of aggregatable global unicast addresses enables strict aggregation of routing prefixes that limits the number of routing table entries in the global routing table. Aggregatable global addresses are used on links that are aggregated upward through organizations, and eventually to the Internet service providers (ISPs).

Aggregatable global IPv6 addresses are defined by a global routing prefix, a subnet ID, and an interface ID. Except for addresses that start with binary 000, all global unicast addresses have a 64-bit interface ID. The IPv6 global unicast address allocation uses the range of addresses that start with binary value 001 (2000::/3). [Figure 1](#) shows the structure of an aggregatable global address.

Figure 1 Aggregatable Global Address Format

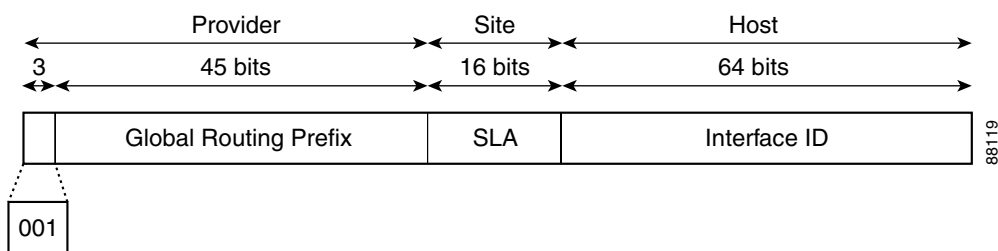

Addresses with a prefix of 2000::/3 (001) through E000::/3 (111) are required to have 64-bit interface identifiers in the extended universal identifier (EUI)-64 format. The Internet Assigned Numbers Authority (IANA) allocates the IPv6 address space in the range of 2000::/16 to regional registries.

The aggregatable global address typically consists of a 48-bit global routing prefix and a 16-bit subnet ID or Site-Level Aggregator (SLA). In the IPv6 aggregatable global unicast address format document (RFC 2374), the global routing prefix included two other hierarchically structured fields named Top-Level Aggregator (TLA) and Next-Level Aggregator (NLA). The IETF decided to remove the TLA and NLA fields from the RFCs because these fields are policy-based. Some existing IPv6 networks deployed before the change might still be using networks based on the older architecture.

A 16-bit subnet field called the subnet ID could be used by individual organizations to create their own local addressing hierarchy and to identify subnets. A subnet ID is similar to a subnet in IPv4, except that an organization with an IPv6 subnet ID can support up to 65,535 individual subnets.

An interface ID is used to identify interfaces on a link. The interface ID must be unique to the link. It may also be unique over a broader scope. In many cases, an interface ID will be the same as or based on the link-layer address of an interface. Interface IDs used in aggregatable global unicast and other IPv6 address types must be 64 bits long and constructed in the modified EUI-64 format.

Interface IDs are constructed in the modified EUI-64 format in one of the following ways:

- For all IEEE 802 interface types (for example, Ethernet, and FDDI interfaces), the first three octets (24 bits) are taken from the Organizationally Unique Identifier (OUI) of the 48-bit link-layer address (MAC address) of the interface, the fourth and fifth octets (16 bits) are a fixed hexadecimal value of FFFE, and the last three octets (24 bits) are taken from the last three octets of the MAC address. The construction of the interface ID is completed by setting the Universal/Local (U/L) bit—the seventh bit of the first octet—to a value of 0 or 1. A value of 0 indicates a locally administered identifier; a value of 1 indicates a globally unique IPv6 interface identifier.

- For all other interface types (for example, serial, loopback, ATM, Frame Relay, and tunnel interface types—except tunnel interfaces used with IPv6 overlay tunnels), the interface ID is constructed in the same way as the interface ID for IEEE 802 interface types; however, the first MAC address from the pool of MAC addresses in the router is used to construct the identifier (because the interface does not have a MAC address).
- For tunnel interface types that are used with IPv6 overlay tunnels, the interface ID is the IPv4 address assigned to the tunnel interface with all zeros in the high-order 32 bits of the identifier.



Note For interfaces using PPP, given that the interfaces at both ends of the connection might have the same MAC address, the interface identifiers used at both ends of the connection are negotiated (picked randomly and, if necessary, reconstructed) until both identifiers are unique. The first MAC address in the router is used to construct the identifier for interfaces using PPP.

If no IEEE 802 interface types are in the router, link-local IPv6 addresses are generated on the interfaces in the router in the following sequence:

1. The router is queried for MAC addresses (from the pool of MAC addresses in the router).
2. If no MAC addresses are available in the router, the serial number of the router is used to form the link-local addresses.
3. If the serial number of the router cannot be used to form the link-local addresses, the router uses a Message Digest 5 (MD5) hash to determine the MAC address of the router from the hostname of the router.

Site-Local Address

A site-local address is an IPv6 unicast address that uses the prefix FEC0::/10 (1111 1110 11) and concatenates the subnet identifier (the 16-bit SLA field) with the interface identifier in the modified EUI-64 format. Site-local addresses can be used to number a complete site without using a globally unique prefix. Site-local addresses can be considered private addresses because they can be used to restrict communication to a limited domain. Figure 2 shows the structure of a site-local address.

IPv6 routers must not forward packets that have site-local source or destination addresses outside of the site.

Figure 2 Site-Local Address Format

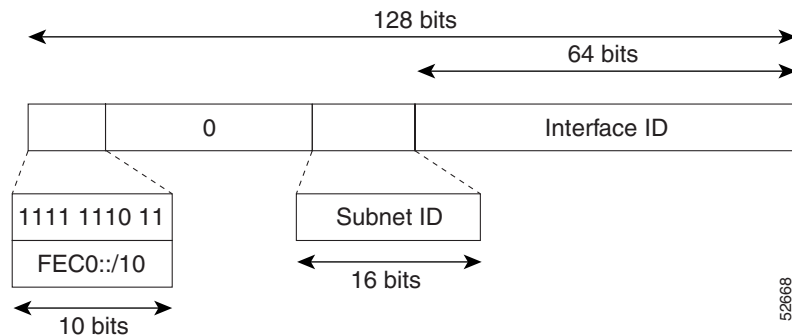

52668

Link-Local Address

A link-local address is an IPv6 unicast address that can be automatically configured on any interface using the link-local prefix FE80::/10 (1111 1110 10) and the interface identifier in the modified EUI-64 format. Link-local addresses are used in the neighbor discovery protocol and the stateless autoconfiguration process. Nodes on a local link can use link-local addresses to communicate; the nodes do not need site-local or globally unique addresses to communicate. [Figure 3](#) shows the structure of a link-local address.

IPv6 routers must not forward packets that have link-local source or destination addresses to other links.

Figure 3 Link-Local Address Format

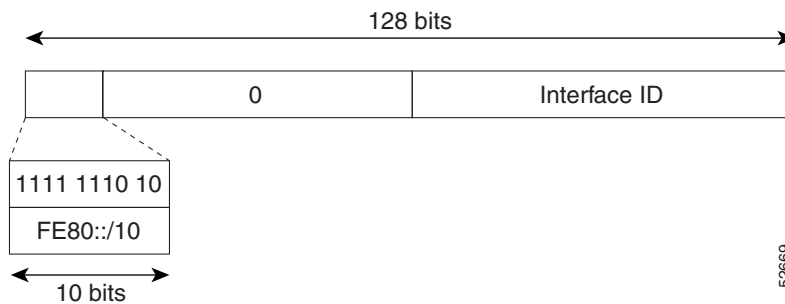

52669

IPv4-Compatible IPv6 Address

An IPv4-compatible IPv6 address is an IPv6 unicast address that has zeros in the high-order 96 bits of the address and an IPv4 address in the low-order 32 bits of the address. The format of an IPv4-compatible IPv6 address is 0:0:0:0:0:A.B.C.D or ::A.B.C.D. The entire 128-bit IPv4-compatible IPv6 address is used as the IPv6 address of a node and the IPv4 address embedded in the low-order 32 bits is used as the IPv4 address of the node. IPv4-compatible IPv6 addresses are assigned to nodes that support both the IPv4 and IPv6 protocol stacks and are used in automatic tunnels. [Figure 4](#) shows the structure of an IPv4-compatible IPv6 address and a few acceptable formats for the address.

Figure 4 IPv4-Compatible IPv6 Address Format

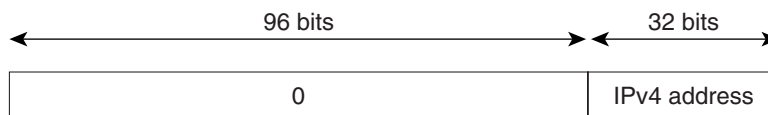

::192.168.30.1
= ::C0A8:1E01

52727

IPv6 Address Type: Anycast

An anycast address is an address that is assigned to a set of interfaces that typically belong to different nodes. A packet sent to an anycast address is delivered to the closest interface—as defined by the routing protocols in use—identified by the anycast address. Anycast addresses are syntactically indistinguishable from unicast addresses because anycast addresses are allocated from the unicast

address space. Assigning a unicast address to more than one interface makes a unicast address an anycast address. Nodes to which the anycast address is assigned must be explicitly configured to recognize that the address is an anycast address.

**Note**

Anycast addresses can be used only by a router, not a host, and anycast addresses must not be used as the source address of an IPv6 packet.

Figure 5 shows the format of the subnet router anycast address; the address has a prefix concatenated by a series of zeros (the interface ID). The subnet router anycast address can be used to reach a router on the link that is identified by the prefix in the subnet router anycast address.

Figure 5 Subnet Router Anycast Address Format

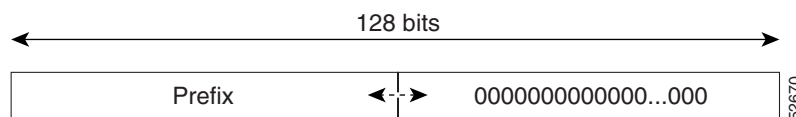

The following shows the configuration for an anycast prefix for 6to4 relay routers:

```
interface Tunnel0
no ip address
ipv6 address 2001:0DB8:A00:1::1/64
ipv6 address 2001:0DB8:c058:6301::/128 anycast
tunnel source Ethernet0
tunnel mode ipv6ip 6to4
!
interface Ethernet0
ip address 10.0.0.1 255.255.255.0
ip address 192.88.99.1 255.255.255.0 secondary
!
ipv6 route 2001:0DB8::/16 Tunnel0
!
```

IPv6 Address Type: Multicast

An IPv6 multicast address is an IPv6 address that has a prefix of FF00::/8 (1111 1111). An IPv6 multicast address is an identifier for a set of interfaces that typically belong to different nodes. A packet sent to a multicast address is delivered to all interfaces identified by the multicast address. The second octet following the prefix defines the lifetime and scope of the multicast address. A permanent multicast address has a lifetime parameter equal to 0; a temporary multicast address has a lifetime parameter equal to 1. A multicast address that has the scope of a node, link, site, or organization, or a global scope has a scope parameter of 1, 2, 5, 8, or E, respectively. For example, a multicast address with the prefix FF02::/16 is a permanent multicast address with a link scope. Figure 6 shows the format of the IPv6 multicast address.

Figure 6 IPv6 Multicast Address Format

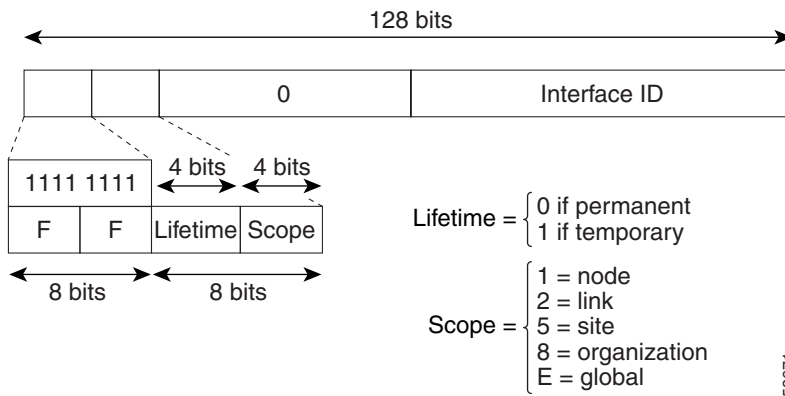

IPv6 nodes (hosts and routers) are required to join (receive packets destined for) the following multicast groups:

- All-nodes multicast group FF02:0:0:0:0:0:0:1 (scope is link-local)
- Solicited-node multicast group FF02:0:0:0:0:1:FF00:0000/104 for each of its assigned unicast and anycast addresses

IPv6 routers must also join the all-routers multicast group FF02:0:0:0:0:0:0:2 (scope is link-local).

The solicited-node multicast address is a multicast group that corresponds to an IPv6 unicast or anycast address. IPv6 nodes must join the associated solicited-node multicast group for every unicast and anycast address to which it is assigned. The IPv6 solicited-node multicast address has the prefix FF02:0:0:0:0:1:FF00:0000/104 concatenated with the 24 low-order bits of a corresponding IPv6 unicast or anycast address (see Figure 7). For example, the solicited-node multicast address corresponding to the IPv6 address 2037::01:800:200E:8C6C is FF02::1:FF0E:8C6C. Solicited-node addresses are used in neighbor solicitation messages.

Figure 7 IPv6 Solicited-Node Multicast Address Format

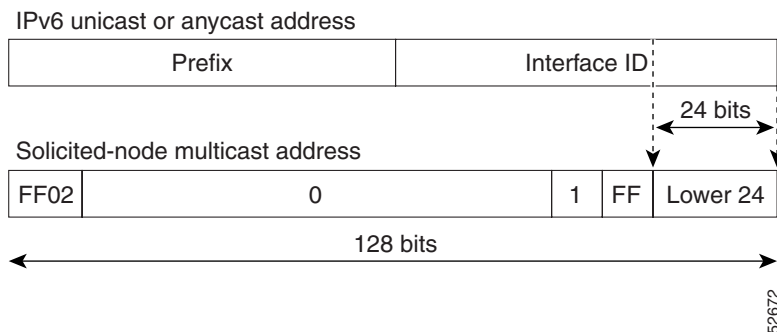

Note

There are no broadcast addresses in IPv6. IPv6 multicast addresses are used instead of broadcast addresses.

For further information on IPv6 multicast, see the *Implementing IPv6 Multicast* document in the Cisco IOS IPv6 Configuration Library.

IPv6 Address Output Display

When IPv6 or IPv4 command output displays an IPv6 address, a long IPv6 address can overflow into neighboring fields, causing the output to be difficult to read. The output fields were designed to work with the longest possible IPv4 address, which has 15 characters; IPv6 addresses can be up to 39 characters long. The following scheme has been adopted in IPv4 and IPv6 commands to allow the appropriate length of IPv6 address to be displayed and move the following fields to the next line, if necessary. The fields that are moved are kept in alignment with the header row.

Using the output display from the **where** command as an example, eight connections are displayed. The first six connections feature IPv6 addresses; the last two connections feature IPv4 addresses.

Router# **where**

Conn	Host	Address	Byte	Idle	Conn	Name
1	test5	2001:0DB8:3333:4::5	6	24	test5	
2	test4	2001:0DB8:3333:44::5				
			6	24	test4	
3	2001:0DB8:3333:4::5	2001:0DB8:3333:4::5	6	24	2001:0DB8:3333:4::5	
4	2001:0DB8:3333:44::5					
		2001:0DB8:3333:44::5				
			6	23	2001:0DB8:3333:44::5	
5	2001:0DB8:3000:4000:5000:6000:7000:8001					
		2001:0DB8:3000:4000:5000:6000:7000:8001				
			6	20	2001:0DB8:3000:4000:5000:6000:	
6	2001:0DB8:1::1	2001:0DB8:1::1	0	1	2001:0DB8:1::1	
7	10.1.9.1	10.1.9.1	0	0	10.1.9.1	
8	10.222.111.222	10.222.111.222	0	0	10.222.111.222	

Connection 1 contains an IPv6 address that uses the maximum address length in the address field. Connection 2 shows the IPv6 address overflowing the address field and the following fields moved to the next line, but in alignment with the appropriate headers. Connection 3 contains an IPv6 address that fills the maximum length of the hostname and address fields without wrapping any lines. Connection 4 shows the effect of both the hostname and address fields containing a long IPv6 address. The output is shown over three lines keeping the correct heading alignment. Connection 5 displays a similar effect as connection 4 with a very long IPv6 address in the hostname and address fields. Note that the connection name field is actually truncated. Connection 6 displays a very short IPv6 address that does not require any change in the display. Connections 7 and 8 display short and long IPv4 addresses.



Note

The IPv6 address output display applies to all commands that display IPv6 addresses.

Simplified IPv6 Packet Header

The basic IPv4 packet header has 12 fields with a total size of 20 octets (160 bits) (see [Figure 8](#)). The 12 fields may be followed by an Options field, which is followed by a data portion that is usually the transport-layer packet. The variable length of the Options field adds to the total size of the IPv4 packet header. The shaded fields of the IPv4 packet header shown in [Figure 8](#) are not included in the IPv6 packet header.

Figure 8 IPv4 Packet Header Format

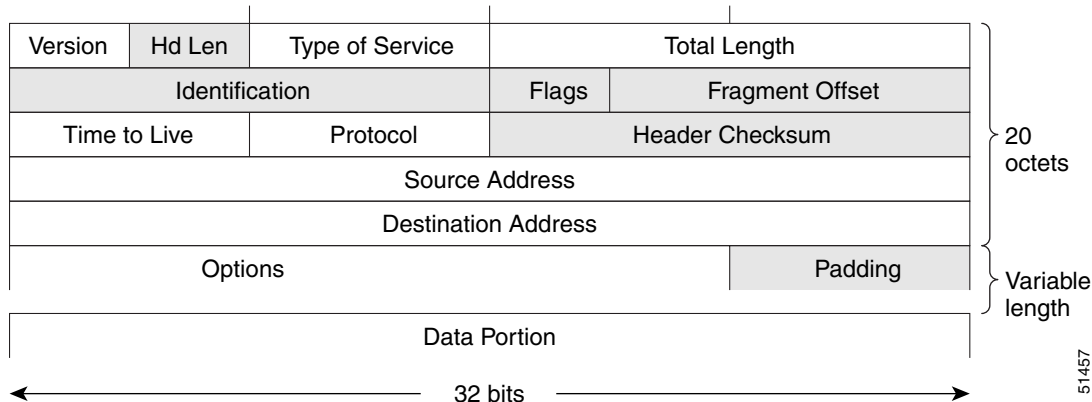

The basic IPv6 packet header has 8 fields with a total size of 40 octets (320 bits) (see Figure 9). Fields were removed from the IPv6 header because, in IPv6, fragmentation is not handled by routers and checksums at the network layer are not used. Instead, fragmentation in IPv6 is handled by the source of a packet and checksums at the data link layer and transport layer are used. (In IPv4, the User Datagram Protocol (UDP) transport layer uses an optional checksum. In IPv6, use of the UDP checksum is required to check the integrity of the inner packet.) Additionally, the basic IPv6 packet header and Options field are aligned to 64 bits, which can facilitate the processing of IPv6 packets.

Figure 9 IPv6 Packet Header Format

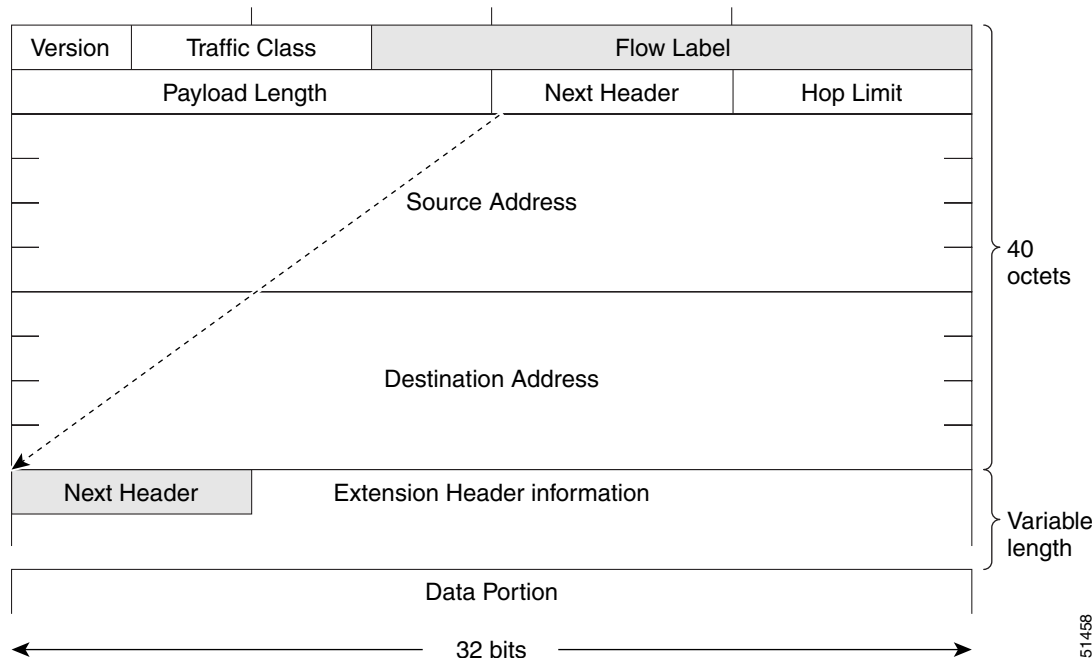

Table 7 lists the fields in the basic IPv6 packet header.

Table 7 Basic IPv6 Packet Header Fields

Field	Description
Version	Similar to the Version field in the IPv4 packet header, except that the field lists number 6 for IPv6 instead of number 4 for IPv4.
Traffic Class	Similar to the Type of Service field in the IPv4 packet header. The Traffic Class field tags packets with a traffic class that is used in differentiated services.
Flow Label	A new field in the IPv6 packet header. The Flow Label field tags packets with a specific flow that differentiates the packets at the network layer.
Payload Length	Similar to the Total Length field in the IPv4 packet header. The Payload Length field indicates the total length of the data portion of the packet.
Next Header	Similar to the Protocol field in the IPv4 packet header. The value of the Next Header field determines the type of information following the basic IPv6 header. The type of information following the basic IPv6 header can be a transport-layer packet, for example, a TCP or UDP packet, or an Extension Header, as shown in Figure 9 .
Hop Limit	Similar to the Time to Live field in the IPv4 packet header. The value of the Hop Limit field specifies the maximum number of routers that an IPv6 packet can pass through before the packet is considered invalid. Each router decrements the value by one. Because no checksum is in the IPv6 header, the router can decrement the value without needing to recalculate the checksum, which saves processing resources.
Source Address	Similar to the Source Address field in the IPv4 packet header, except that the field contains a 128-bit source address for IPv6 instead of a 32-bit source address for IPv4.
Destination Address	Similar to the Destination Address field in the IPv4 packet header, except that the field contains a 128-bit destination address for IPv6 instead of a 32-bit destination address for IPv4.

Following the eight fields of the basic IPv6 packet header are optional extension headers and the data portion of the packet. If present, each extension header is aligned to 64 bits. There is no fixed number of extension headers in an IPv6 packet. Together, the extension headers form a chain of headers. Each extension header is identified by the Next Header field of the previous header. Typically, the final extension header has a Next Header field of a transport-layer protocol, such as TCP or UDP. [Figure 10](#) shows the IPv6 extension header format.

Figure 10 IPv6 Extension Header Format

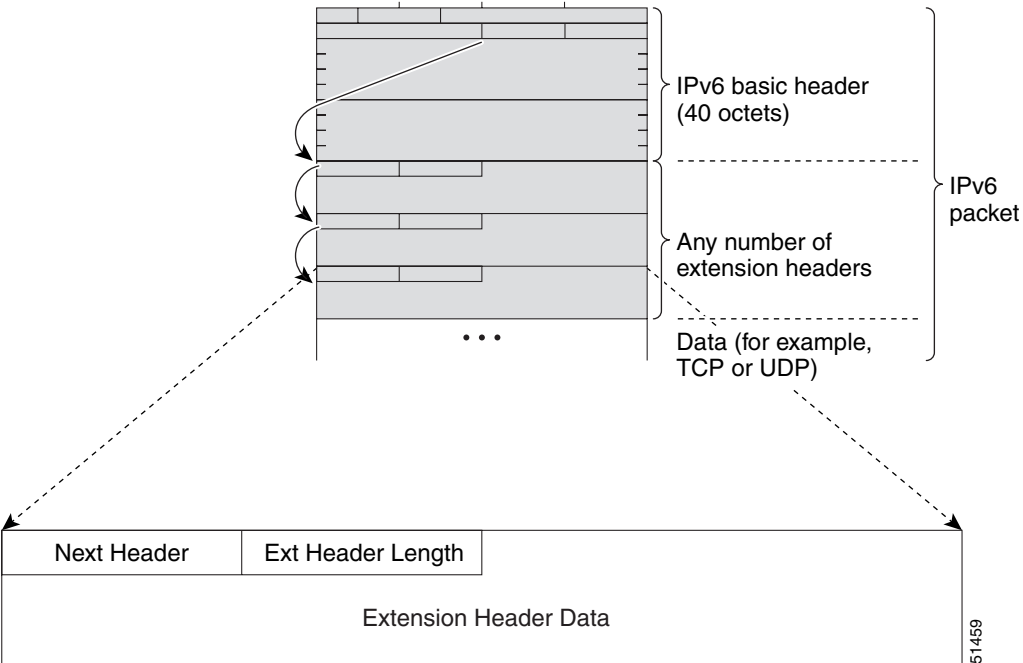

Table 8 lists the extension header types and their Next Header field values.

Table 8 IPv6 Extension Header Types

Header Type	Next Header Value	Description
Hop-by-hop options header	0	This header is processed by all hops in the path of a packet. When present, the hop-by-hop options header always follows immediately after the basic IPv6 packet header.
Destination options header	60	The destination options header can follow any hop-by-hop options header, in which case the destination options header is processed at the final destination and also at each visited address specified by a routing header. Alternatively, the destination options header can follow any Encapsulating Security Payload (ESP) header, in which case the destination options header is processed only at the final destination.
Routing header	43	The routing header is used for source routing.
Fragment header	44	The fragment header is used when a source must fragment a packet that is larger than the Maximum Transmission Unit (MTU) for the path between itself and a destination. The Fragment header is used in each fragmented packet.
Authentication header and ESP header	51 50	The Authentication header and the ESP header are used within IP Security Protocol (IPSec) to provide authentication, integrity, and confidentiality of a packet. These headers are identical for both IPv4 and IPv6.
Upper-layer headers	6 (TCP) 17 (UDP)	The upper-layer (transport) headers are the typical headers used inside a packet to transport the data. The two main transport protocols are TCP and UDP.
Mobility headers	135	Extension headers used by mobile nodes, correspondent nodes, and home agents in all messaging related to the creation and management of bindings.

The Cisco IOS system logging (syslog) process in IPv6 allows users to log syslog messages to external syslog servers and hosts with IPv6 addresses. This implementation allows user to specify an IPv4-based logging host (syslog server) by providing the host's IP address in IPv4 format (for example, 192.168.0.0) or IPv6 format (for example, 2001:0DB8:A00:1::1/64).

The feature is backward compatible with existing IPv4 and new IPv6 addresses and hostnames.

Cisco Express Forwarding and distributed Cisco Express Forwarding Switching for IPv6

Cisco Express Forwarding is advanced, Layer 3 IP switching technology for the forwarding of IPv6 packets. Distributed Cisco Express Forwarding performs the same functions as Cisco Express Forwarding but for distributed architecture platforms such as the Cisco 12000 series Internet routers and the Cisco 7500 series routers. Distributed Cisco Express Forwarding for IPv6 and Cisco Express Forwarding for IPv6 function the same and offer the same benefits as for distributed Cisco Express Forwarding for IPv4 and Cisco Express Forwarding for IPv4—network entries that are added, removed,

or modified in the IPv6 Routing Information Base (RIB), as dictated by the routing protocols in use, are reflected in the Forwarding Information Bases (FIBs), and the IPv6 adjacency tables maintain Layer 2 next-hop addresses for all entries in each FIB.

**Note**

By default, the Cisco 12000 series Internet routers support only distributed Cisco Express Forwarding (Cisco Express Forwarding switching is performed by the line cards). The Cisco 7500 series routers support both Cisco Express Forwarding and distributed Cisco Express Forwarding. When Cisco Express Forwarding is configured on Cisco 7500 series routers, Cisco Express Forwarding switching is performed by the Route Processor (RP); when distributed Cisco Express Forwarding is configured, Cisco Express Forwarding switching is performed by the line cards.

In Cisco IOS Release 12.0(21)ST, distributed Cisco Express Forwarding included support for IPv6 addresses and prefixes. In Cisco IOS Release 12.0(22)S or later releases and Cisco IOS Release 12.2(13)T or later releases, distributed Cisco Express Forwarding and Cisco Express Forwarding were enhanced to include support for separate FIBs for IPv6 global, site-local, and link-local addresses.

Each IPv6 router interface has an association to one IPv6 global FIB, one IPv6 site-local FIB, and one IPv6 link-local FIB (multiple interfaces can have an association to the same FIB). All IPv6 router interfaces that are attached to the same IPv6 link share the same IPv6 link-local FIB. IPv6 packets that have an IPv6 global destination address are processed by the IPv6 global FIB; however, packets that have an IPv6 global destination address and either an IPv6 site-local or link-local source address are sent to the RP for process switching and scope-error handling. IPv6 packets that have a site-local destination address are processed by the IPv6 site-local FIB; however, packets that have a link-local source address are not forwarded off of the local link and are sent to the RP for process switching and scope-error handling.

Unicast Reverse Path Forwarding

Use the Unicast RPF feature to mitigate problems caused by malformed or forged (spoofed) IPv6 source addresses that pass through an IPv6 router. Malformed or forged source addresses can indicate denial-of-service (DoS) attacks based on source IPv6 address spoofing.

When Unicast RPF is enabled on an interface, the router examines all packets received on that interface. The router verifies that the source address appears in the routing table and matches the interface on which the packet was received. This “look backward” ability is available only when Cisco Express Forwarding is enabled on the router, because the lookup relies on the presence of the FIB. Cisco Express Forwarding generates the FIB as part of its operation.

**Note**

Unicast RPF is an input function and is applied only on the input interface of a router at the upstream end of a connection.

The Unicast RPF feature verifies whether any packet received at a router interface arrives on one of the best return paths to the source of the packet. The feature performs a reverse lookup in the Cisco Express Forwarding table. If Unicast RPF does not find a reverse path for the packet, Unicast RPF can drop or forward the packet, depending on whether an access control list (ACL) is specified. If an ACL is specified, then when (and only when) a packet fails the Unicast RPF check, the ACL is checked to verify if the packet should be dropped (using a deny statement in the ACL) or forwarded (using a permit statement in the ACL). Whether a packet is dropped or forwarded, the packet is counted in the global IP traffic statistics for Unicast RPF drops and in the interface statistics for Unicast RPF.

If no ACL is specified, the router drops the forged or malformed packet immediately and no ACL logging occurs. The router and interface Unicast RPF counters are updated.

Unicast RPF events can be logged by specifying the logging option for the ACL entries. Log information can be used to gather information about the attack, such as source address and time.

**Note**

With Unicast RPF, all equal-cost “best” return paths are considered valid. Unicast RPF works in cases where multiple return paths exist, provided that each path is equal to the others in terms of the routing cost (number of hops, weights, and so on) and as long as the route is in the FIB.

DNS for IPv6

IPv6 supports DNS record types that are supported in the DNS name-to-address and address-to-name lookup processes. The DNS record types support IPv6 addresses. IPv6 also supports the reverse mapping of IPv6 addresses to DNS names.

**Note**

IP6.ARPA support was added in the Cisco IOS 12.3(11)T release. IP6.ARPA is not supported in releases prior to the Cisco IOS 12.3(11)T release.

[Table 9](#) lists the IPv6 DNS record types.

Table 9 IPv6 DNS Record Types

Record Type	Description	Format
AAAA	Maps a hostname to an IPv6 address. (Equivalent to an A record in IPv4.) Note Support for AAAA records and A records over an IPv6 transport or IPv4 transport is in Cisco IOS Release 12.2(8)T or later releases.	www.abc.test AAAA 3FFE:YYYY:C18:1::2
PTR	Maps an IPv6 address to a hostname. (Equivalent to a PTR record in IPv4.) Note The Cisco IOS software supports resolution of PTR records for the IP6.INT domain.	2.0.0.0.0.0.0.0.0.0.0.0.0.0.0.0.1.0.0.8.1.c.0.y.y.y.e.f.f.3.ip6.int PTR www.abc.test

Path MTU Discovery for IPv6

As in IPv4, path MTU discovery in IPv6 allows a host to dynamically discover and adjust to differences in the MTU size of every link along a given data path. In IPv6, however, fragmentation is handled by the source of a packet when the path MTU of one link along a given data path is not large enough to accommodate the size of the packets. Having IPv6 hosts handle packet fragmentation saves IPv6 router processing resources and helps IPv6 networks run more efficiently.

**Note**

In IPv6, the minimum link MTU is 1280 octets. We recommend using an MTU value of 1500 octets for IPv6 links.

Cisco Discovery Protocol IPv6 Address Support

The Cisco Discovery Protocol (formerly known as CDP) IPv6 address support for neighbor information feature adds the ability to transfer IPv6 addressing information between two Cisco devices.

Cisco Discovery Protocol support for IPv6 addresses provides IPv6 information to network management products and troubleshooting tools.

ICMP for IPv6

Internet Control Message Protocol (ICMP) in IPv6 functions the same as ICMP in IPv4—ICMP generates error messages, such as ICMP destination unreachable messages, and informational messages, such as ICMP echo request and reply messages. Additionally, ICMP packets in IPv6 are used in the IPv6 neighbor discovery process, path MTU discovery, and the Multicast Listener Discovery (MLD) protocol for IPv6. MLD is used by IPv6 routers to discover multicast listeners (nodes that want to receive multicast packets destined for specific multicast addresses) on directly attached links. MLD is based on version 2 of the Internet Group Management Protocol (IGMP) for IPv4.

A value of 58 in the Next Header field of the basic IPv6 packet header identifies an IPv6 ICMP packet. ICMP packets in IPv6 are like a transport-layer packet in the sense that the ICMP packet follows all the extension headers and is the last piece of information in the IPv6 packet. Within IPv6 ICMP packets, the ICMPv6 Type and ICMPv6 Code fields identify IPv6 ICMP packet specifics, such as the ICMP message type. The value in the Checksum field is derived (computed by the sender and checked by the receiver) from the fields in the IPv6 ICMP packet and the IPv6 pseudoheader. The ICMPv6 Data field contains error or diagnostic information relevant to IP packet processing. [Figure 11](#) shows the IPv6 ICMP packet header format.

Figure 11 IPv6 ICMP Packet Header Format

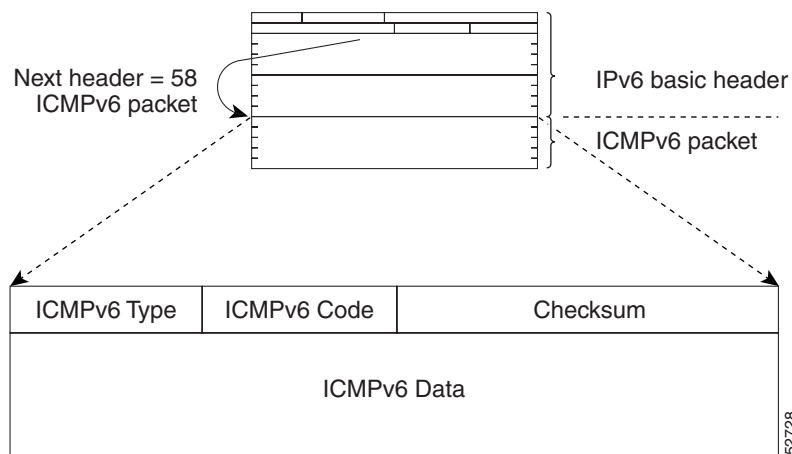

IPv6 Neighbor Discovery

The IPv6 neighbor discovery process uses ICMP messages and solicited-node multicast addresses to determine the link-layer address of a neighbor on the same network (local link), verify the reachability of a neighbor, and track neighboring routers.

The IPv6 static cache entry for neighbor discovery feature allows static entries to be made in the IPv6 neighbor cache. Static routing requires an administrator to manually enter IPv6 addresses, subnet masks, gateways, and corresponding MAC addresses for each interface of each router into a table. Static routing enables more control but requires more work to maintain the table. The table must be updated each time routes are added or changed.

IPv6 Neighbor Solicitation Message

A value of 135 in the Type field of the ICMP packet header identifies a neighbor solicitation message. Neighbor solicitation messages are sent on the local link when a node wants to determine the link-layer address of another node on the same local link (see Figure 12). When a node wants to determine the link-layer address of another node, the source address in a neighbor solicitation message is the IPv6 address of the node sending the neighbor solicitation message. The destination address in the neighbor solicitation message is the solicited-node multicast address that corresponds to the IPv6 address of the destination node. The neighbor solicitation message also includes the link-layer address of the source node.

Figure 12 IPv6 Neighbor Discovery—Neighbor Solicitation Message

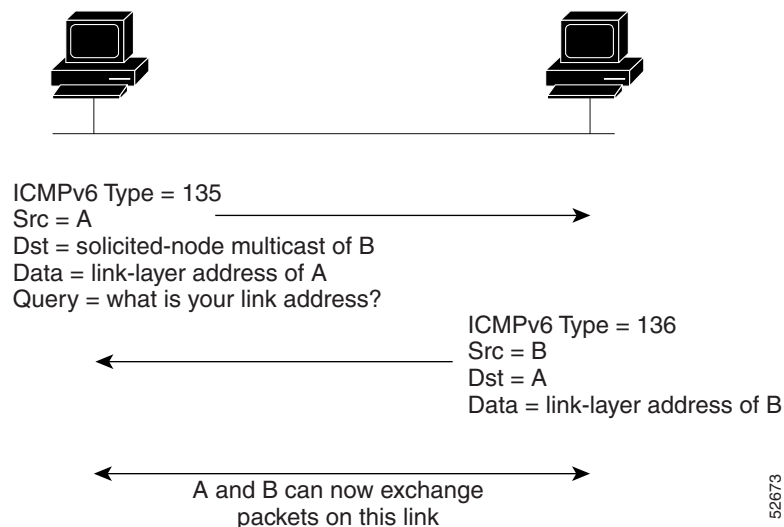

After receiving the neighbor solicitation message, the destination node replies by sending a neighbor advertisement message, which has a value of 136 in the Type field of the ICMP packet header, on the local link. The source address in the neighbor advertisement message is the IPv6 address of the node (more specifically, the IPv6 address of the node interface) sending the neighbor advertisement message. The destination address in the neighbor advertisement message is the IPv6 address of the node that sent the neighbor solicitation message. The data portion of the neighbor advertisement message includes the link-layer address of the node sending the neighbor advertisement message.

After the source node receives the neighbor advertisement, the source node and destination node can communicate.

Neighbor solicitation messages are also used to verify the reachability of a neighbor after the link-layer address of a neighbor is identified. When a node wants to verify the reachability of a neighbor, the destination address in a neighbor solicitation message is the unicast address of the neighbor.

Neighbor advertisement messages are also sent when there is a change in the link-layer address of a node on a local link. When there is such a change, the destination address for the neighbor advertisement is the all-nodes multicast address.

Neighbor solicitation messages are also used to verify the reachability of a neighbor after the link-layer address of a neighbor is identified. Neighbor unreachability detection identifies the failure of a neighbor or the failure of the forward path to the neighbor, and is used for all paths between hosts and neighboring nodes (hosts or routers). Neighbor unreachability detection is performed for neighbors to which only unicast packets are being sent and is not performed for neighbors to which multicast packets are being sent.

A neighbor is considered reachable when a positive acknowledgment is returned from the neighbor (indicating that packets previously sent to the neighbor have been received and processed). A positive acknowledgment—from an upper-layer protocol (such as TCP)—indicates that a connection is making forward progress (reaching its destination) or the receipt of a neighbor advertisement message in response to a neighbor solicitation message. If packets are reaching the peer, they are also reaching the next-hop neighbor of the source. Therefore, forward progress is also a confirmation that the next-hop neighbor is reachable.

For destinations that are not on the local link, forward progress implies that the first-hop router is reachable. When acknowledgments from an upper-layer protocol are not available, a node probes the neighbor using unicast neighbor solicitation messages to verify that the forward path is still working.

The return of a solicited neighbor advertisement message from the neighbor is a positive acknowledgment that the forward path is still working (neighbor advertisement messages that have the solicited flag set to a value of 1 are sent only in response to a neighbor solicitation message). Unsolicited messages confirm only the one-way path from the source to the destination node; solicited neighbor advertisement messages indicate that a path is working in both directions.

**Note**

A neighbor advertisement message that has the solicited flag set to a value of 0 must not be considered as a positive acknowledgment that the forward path is still working.

Neighbor solicitation messages are also used in the stateless autoconfiguration process to verify the uniqueness of unicast IPv6 addresses before the addresses are assigned to an interface. Duplicate address detection is performed first on a new, link-local IPv6 address before the address is assigned to an interface (the new address remains in a tentative state while duplicate address detection is performed). Specifically, a node sends a neighbor solicitation message with an unspecified source address and a tentative link-local address in the body of the message. If another node is already using that address, the node returns a neighbor advertisement message that contains the tentative link-local address. If another node is simultaneously verifying the uniqueness of the same address, that node also returns a neighbor solicitation message. If no neighbor advertisement messages are received in response to the neighbor solicitation message and no neighbor solicitation messages are received from other nodes that are attempting to verify the same tentative address, the node that sent the original neighbor solicitation message considers the tentative link-local address to be unique and assigns the address to the interface.

Every IPv6 unicast address (global or link-local) must be verified for uniqueness on the link; however, until the uniqueness of the link-local address is verified, duplicate address detection is not performed on any other IPv6 addresses associated with the link-local address. The Cisco implementation of duplicate address detection in the Cisco IOS software does not verify the uniqueness of anycast or global addresses that are generated from 64-bit interface identifiers.

IPv6 Router Advertisement Message

Router advertisement (RA) messages, which have a value of 134 in the Type field of the ICMP packet header, are periodically sent out each configured interface of an IPv6 router. For stateless autoconfiguration to work properly, the advertised prefix length in RA messages must always be 64 bits.

The RA messages are sent to the all-nodes multicast address (see [Figure 13](#)).

Figure 13 IPv6 Neighbor Discovery—RA Message

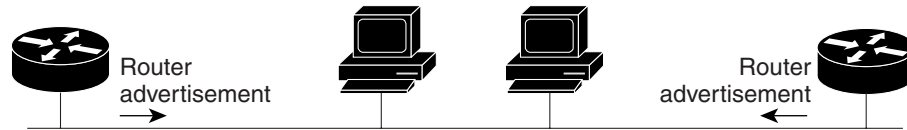

Router advertisement packet definitions:

ICMPv6 Type = 134

Src = router link-local address

Dst = all-nodes multicast address

Data = options, prefix, lifetime, autoconfig flag

52674

RA messages typically include the following information:

- One or more onlink IPv6 prefixes that nodes on the local link can use to automatically configure their IPv6 addresses
- Lifetime information for each prefix included in the advertisement
- Sets of flags that indicate the type of autoconfiguration (stateless or stateful) that can be completed
- Default router information (whether the router sending the advertisement should be used as a default router and, if so, the amount of time (in seconds) the router should be used as a default router)
- Additional information for hosts, such as the hop limit and MTU a host should use in packets that it originates

RAs are also sent in response to router solicitation messages. Router solicitation messages, which have a value of 133 in the Type field of the ICMP packet header, are sent by hosts at system startup so that the host can immediately autoconfigure without needing to wait for the next scheduled RA message. Given that router solicitation messages are usually sent by hosts at system startup (the host does not have a configured unicast address), the source address in router solicitation messages is usually the unspecified IPv6 address (0:0:0:0:0:0:0:0). If the host has a configured unicast address, the unicast address of the interface sending the router solicitation message is used as the source address in the message. The destination address in router solicitation messages is the all-routers multicast address with a scope of the link. When an RA is sent in response to a router solicitation, the destination address in the RA message is the unicast address of the source of the router solicitation message.

The following RA message parameters can be configured:

- The time interval between periodic RA messages
- The “router lifetime” value, which indicates the usefulness of a router as the default router (for use by all nodes on a given link)
- The network prefixes in use on a given link
- The time interval between neighbor solicitation message retransmissions (on a given link)
- The amount of time a node considers a neighbor reachable (for use by all nodes on a given link)

The configured parameters are specific to an interface. The sending of RA messages (with default values) is automatically enabled on Ethernet and FDDI interfaces when the **ipv6 unicast-routing** command is configured. For other interface types, the sending of RA messages must be manually configured by using the **no ipv6 nd ra suppress** command. The sending of RA messages can be disabled on individual interfaces by using the **ipv6 nd ra suppress** command.

**Note**

As of Cisco IOS Release 12.4(2)T, the **ipv6 nd ra suppress** and **no ipv6 nd ra suppress** commands replace the **ipv6 nd suppress-ra** and **no ipv6 nd suppress-ra** commands.

Default Router Preferences for Traffic Engineering

Hosts discover and select default routers by listening to RAs. Typical default router selection mechanisms are suboptimal in certain cases, such as when traffic engineering is needed. For example, two routers on a link may provide equivalent but not equal-cost routing, and policy may dictate that one of the routers is preferred. Some examples are as follows:

- Multiple routers that route to distinct sets of prefixes—Redirects (sent by nonoptimal routers for a destination) mean that hosts can choose any router and the system will work. However, traffic patterns may mean that choosing one of the routers would lead to considerably fewer redirects.
- Accidentally deploying a new router—Deploying a new router before it has been fully configured could lead to hosts adopting the new router as a default router and traffic disappearing. Network managers may want to indicate that some routers are more preferred than others.
- Multihomed situations—Multihomed situations may become more common, because of multiple physical links and because of the use of tunneling for IPv6 transport. Some of the routers may not provide full default routing because they route only to the 6-to-4 prefix or they route only to a corporate intranet. These situations cannot be resolved with redirects, which operate only over a single link.

The default router preference (DRP) extension provides a coarse preference metric (low, medium, or high) for default routers. The DRP of a default router is signaled in unused bits in RA messages. This extension is backward compatible, both for routers (setting the DRP bits) and hosts (interpreting the DRP bits). These bits are ignored by hosts that do not implement the DRP extension. Similarly, the values sent by routers that do not implement the DRP extension will be interpreted by hosts that do implement it as indicating a “medium” preference.

DRPs need to be configured manually. For information on configuring the optional DRP extension, see the “[Configuring the DRP Extension for Traffic Engineering](#)” section.

IPv6 Neighbor Redirect Message

A value of 137 in the Type field of the ICMP packet header identifies an IPv6 neighbor redirect message. Routers send neighbor redirect messages to inform hosts of better first-hop nodes on the path to a destination (see [Figure 14](#)).

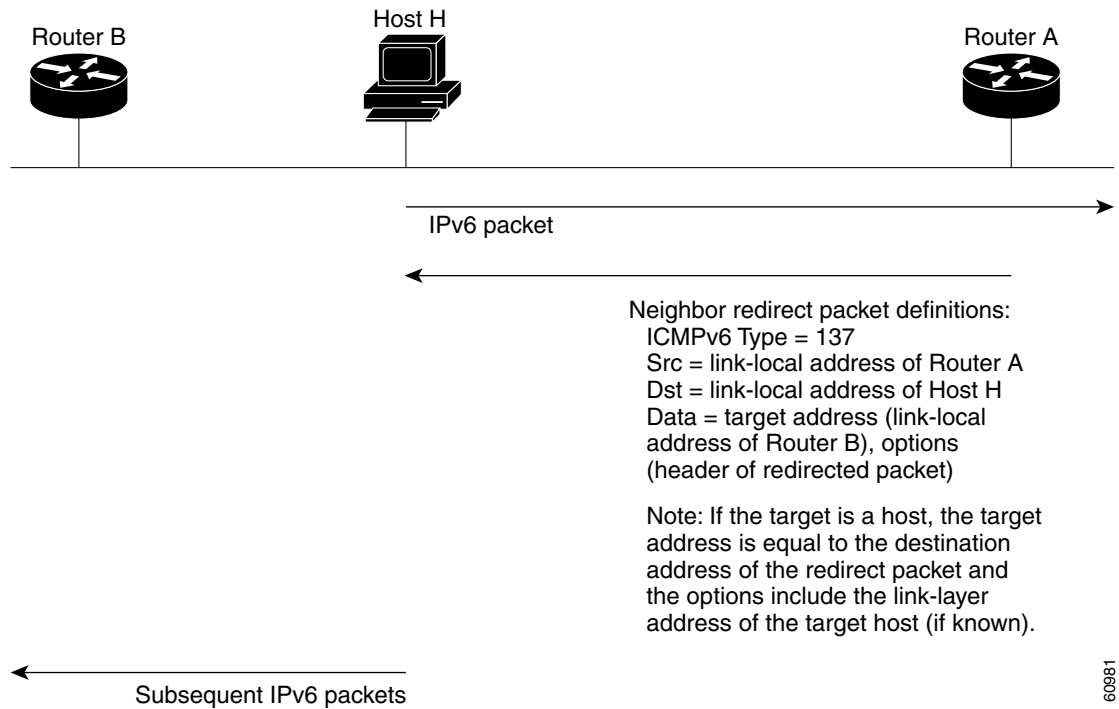
Figure 14 IPv6 Neighbor Discovery—Neighbor Redirect Message**Note**

A router must be able to determine the link-local address for each of its neighboring routers in order to ensure that the target address (the final destination) in a redirect message identifies the neighbor router by its link-local address. For static routing, the address of the next-hop router should be specified using the link-local address of the router; for dynamic routing, all IPv6 routing protocols must exchange the link-local addresses of neighboring routers.

After forwarding a packet, a router should send a redirect message to the source of the packet under the following circumstances:

- The destination address of the packet is not a multicast address.
- The packet was not addressed to the router.
- The packet is about to be sent out the interface on which it was received.
- The router determines that a better first-hop node for the packet resides on the same link as the source of the packet.
- The source address of the packet is a global IPv6 address of a neighbor on the same link, or a link-local address.

Use the **ipv6 icmp error-interval** command to limit the rate at which the router generates all IPv6 ICMP error messages, including neighbor redirect messages, which ultimately reduces link-layer congestion.

**Note**

A router must not update its routing tables after receiving a neighbor redirect message, and hosts must not originate neighbor redirect messages.

HSRP for IPv6

The Hot Standby Router Protocol (HSRP) is a first-hop routing protocol (FHRP) designed to allow for transparent failover of the first-hop IP router. HSRP provides high network availability by providing first-hop routing redundancy for IP hosts on Ethernet configured with a default gateway IP address. HSRP is used in a group of routers for selecting an active router and a standby router. In a group of router interfaces, the active router is the router of choice for routing packets; the standby router is the router that takes over when the active router fails or when preset conditions are met.

Most IPv4 hosts have a single router's IP address configured as the default gateway. When HSRP is used, then the HSRP virtual IP address is configured as the host's default gateway instead of the router's IP address. Simple load sharing may be achieved by using two HSRP groups and configuring half the hosts with one virtual IP address and half the hosts with the other virtual IP address.

In contrast, IPv6 hosts learn of available IPv6 routers through IPv6 neighbor discovery RA messages. These are multicast periodically, or may be solicited by hosts. HSRP is designed to provide only a virtual first hop for IPv6 hosts.

An HSRP IPv6 group has a virtual MAC address that is derived from the HSRP group number, and a virtual IPv6 link-local address that is, by default, derived from the HSRP virtual MAC address. Periodic RAs are sent for the HSRP virtual IPv6 link-local address when the HSRP group is active. These RAs stop after a final RA is sent when the group leaves the active state.

Periodic RAs for the interface link-local address stop after a final RA is sent while at least one virtual IPv6 link-local address is configured on the interface. No restrictions occur for the interface IPv6 link-local address other than that mentioned for the RAs. Other protocols continue to receive and send packets to this address.

HSRP IPv6 Virtual MAC Address Range

HSRP IPv6 uses a different virtual MAC address block than does HSRP for IP:

0005.73A0.0000 through 0005.73A0.0FFF (4096 addresses)

HSRP IPv6 UDP Port Number

Port number 2029 has been assigned to HSRP IPv6.

Link, Subnet, and Site Addressing Changes

This section describes the IPv6 stateless autoconfiguration and general prefix features, which can be used to manage link, subnet, and site addressing changes.

IPv6 Stateless Autoconfiguration

All interfaces on IPv6 nodes must have a link-local address, which is usually automatically configured from the identifier for an interface and the link-local prefix FE80::/10. A link-local address enables a node to communicate with other nodes on the link and can be used to further configure the node.

Nodes can connect to a network and automatically generate site-local and global IPv6 address without the need for manual configuration or help of a server, such as a Dynamic Host Configuration Protocol (DHCP) server. With IPv6, a router on the link advertises in RA messages any site-local and global prefixes, and its willingness to function as a default router for the link. RA messages are sent periodically and in response to router solicitation messages, which are sent by hosts at system startup (see [Figure 15](#)).

Figure 15 IPv6 Stateless Autoconfiguration

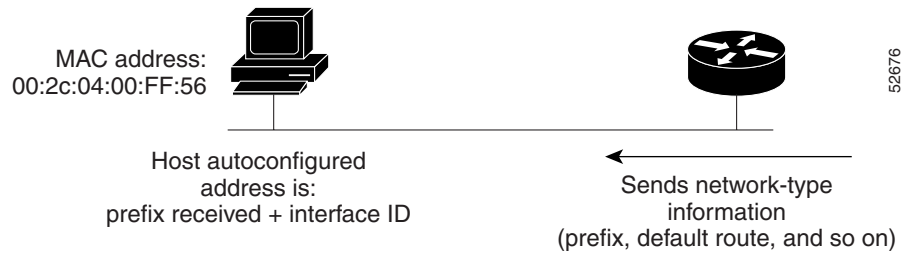

A node on the link can automatically configure site-local and global IPv6 addresses by appending its interface identifier (64 bits) to the prefixes (64 bits) included in the RA messages. The resulting 128-bit IPv6 addresses configured by the node are then subjected to duplicate address detection to ensure their uniqueness on the link. If the prefixes advertised in the RA messages are globally unique, then the IPv6 addresses configured by the node are also guaranteed to be globally unique. Router solicitation messages, which have a value of 133 in the Type field of the ICMP packet header, are sent by hosts at system startup so that the host can immediately autoconfigure without needing to wait for the next scheduled RA message.

Simplified Network Renumbering for IPv6 Hosts

The strict aggregation of the global routing table requires that networks be renumbered when the service provider for the network is changed. When the stateless autoconfiguration functionality in IPv6 is used to renumber a network, the prefix from a new service provider is added to RA messages that are sent on the link. (The RA messages contain both the prefix from the old service provider and the prefix from the new service provider.) Nodes on the link automatically configure additional addresses by using the prefix from the new service provider. The nodes can then use the addresses created from the new prefix and the existing addresses created from the old prefix on the link. Configuration of the lifetime parameters associated with the old and new prefixes means that nodes on the link can make the transition to using only addresses created from the new prefix. During a transition period, the old prefix is removed from RA messages and only addresses that contain the new prefix are used on the link (the renumbering is complete) (see [Figure 16](#)).

Figure 16 IPv6 Network Renumbering for Hosts Using Stateless Autoconfiguration

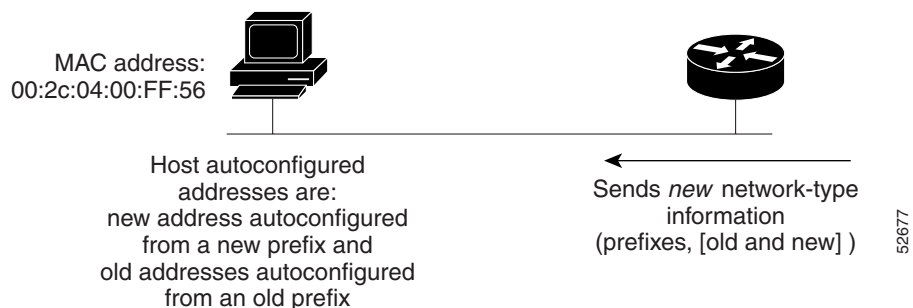

IPv6 General Prefixes

The upper 64 bits of an IPv6 address are composed from a global routing prefix plus a subnet ID, as defined in RFC 3513. A general prefix (for example, /48) holds a short prefix, based on which a number of longer, more specific prefixes (for example, /64) can be defined. When the general prefix is changed, all of the more specific prefixes based on it will change, too. This function greatly simplifies network renumbering and allows for automated prefix definition.

For example, a general prefix might be 48 bits long (“/48”) and the more specific prefixes generated from it might be 64 bits long (“/64”). In the following example, the leftmost 48 bits of all the specific prefixes will be the same—and the same as the general prefix itself. The next 16 bits are all different.

- General prefix: 2001:0DB8:2222::/48
- Specific prefix: 2001:0DB8:2222:0000::/64
- Specific prefix: 2001:0DB8:2222:0001::/64
- Specific prefix: 2001:0DB8:2222:4321::/64
- Specific prefix: 2001:0DB8:2222:7744::/64

General prefixes can be defined in several ways:

- Manually
- Based on a 6to4 interface
- Dynamically, from a prefix received by a DHCP for IPv6 prefix delegation client

More specific prefixes, based on a general prefix, can be used when configuring IPv6 on an interface.

DHCP for IPv6 Prefix Delegation

DHCP for IPv6 can be used in environments to deliver stateful and stateless information. For further information about this feature, see the *Implementing DHCP for IPv6* module in the Cisco IOS IPv6 Configuration Library.

IPv6 Prefix Aggregation

The aggregatable nature of the IPv6 address space enables an IPv6 addressing hierarchy. For example, an enterprise can subdivide a single IPv6 prefix from a service provider into multiple, longer prefixes for use within its internal network. Conversely, a service provider can aggregate all of the prefixes of its customers into a single, shorter prefix that the service provider can then advertise over the IPv6 internet (see [Figure 17](#)).

Figure 17 IPv6 Prefix Aggregation

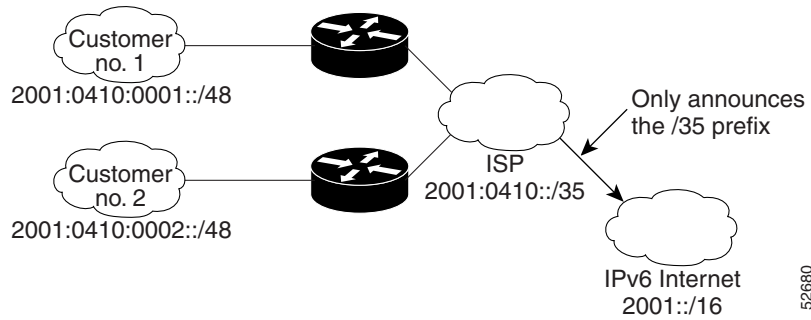

IPv6 Site Multihoming

Multiple IPv6 prefixes can be assigned to networks and hosts. Having multiple prefixes assigned to a network makes it easy for that network to connect to multiple ISPs without breaking the global routing table (see Figure 18).

Figure 18 IPv6 Site Multihoming

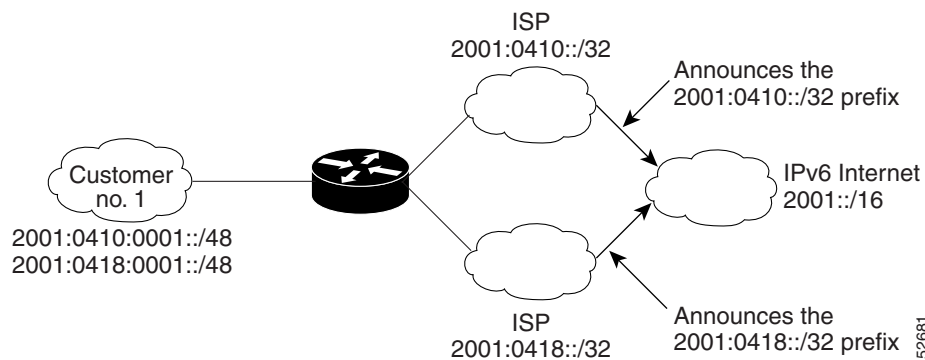

IPv6 Data Links

In IPv6 networks, a data link is a network sharing a particular link-local prefix. Data links are networks arbitrarily segmented by a network administrator in order to provide a multilevel, hierarchical routing structure while shielding the subnetwork from the addressing complexity of attached networks. The function of a subnetwork in IPv6 is similar to a subnetwork in IPv4. A subnetwork prefix is associated with one data link; multiple subnetwork prefixes may be assigned to the same data link.

The following data links are supported for IPv6: ATM permanent virtual circuit (PVC) and ATM LANE, Ethernet, Fast Ethernet, Gigabit Ethernet, FDDI, Frame Relay PVC, Cisco High-Level Data Link Control (HDLC), PPP over Packet Over SONET, ISDN, serial interfaces, and dynamic packet transport (DPT). See the *Start Here: Cisco IOS Software Release Specifics for IPv6 Features* for release details on supported data links.

Routed Bridge Encapsulation for IPv6

Routed bridge encapsulation (RBE) provides a mechanism for routing a protocol from a bridged interface to another routed or bridged interface. RBE for IPv6 can be used on ATM point-to-point subinterfaces that are configured for IPv6 half-bridging. Routing of IP packets and IPv6 half-bridging, bridging, PPP over Ethernet (PPPoE), or other Ethernet 802.3-encapsulated protocols can be configured on the same subinterface.

Dual IPv4 and IPv6 Protocol Stacks

The dual IPv4 and IPv6 protocol stack technique can be used to transition to IPv6. It enables gradual, one-by-one upgrades to applications running on nodes. Applications running on nodes are upgraded to make use of the IPv6 protocol stack. Applications that are not upgraded—they support only the IPv4 protocol stack—can coexist with upgraded applications on a node. New and upgraded applications make use of both the IPv4 and IPv6 protocol stacks (see Figure 19).

Figure 19 Dual IPv4 and IPv6 Protocol Stack Technique

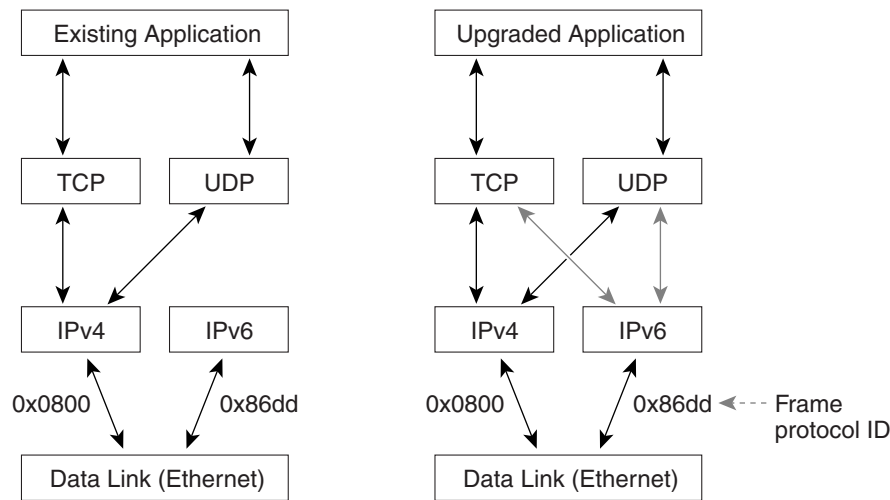

One application program interface (API) supports both IPv4 and IPv6 addresses and DNS requests. An application can be upgraded to the new API and still use only the IPv4 protocol stack. The Cisco IOS software supports the dual IPv4 and IPv6 protocol stack technique. When an interface is configured with both an IPv4 and an IPv6 address, the interface will forward both IPv4 and IPv6 traffic.

In Figure 20, an application that supports dual IPv4 and IPv6 protocol stacks requests all available addresses for the destination hostname `www.a.com` from a DNS server. The DNS server replies with all available addresses (both IPv4 and IPv6 addresses) for `www.a.com`. The application chooses an address—in most cases, IPv6 addresses are the default choice—and connects the source node to the destination using the IPv6 protocol stack.

Figure 20 Dual IPv4 and IPv6 Protocol Stack Applications

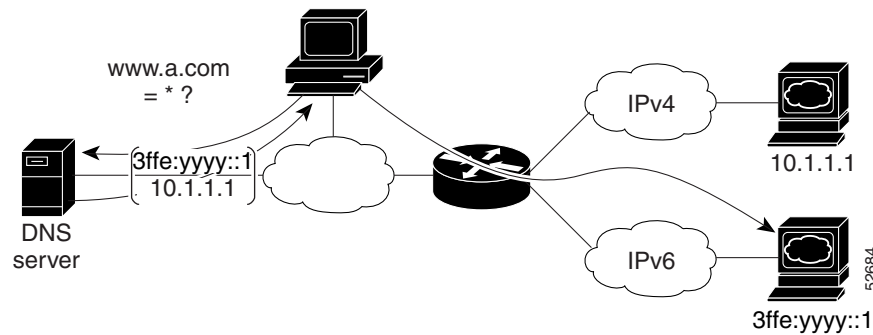

How to Implement IPv6 Addressing and Basic Connectivity

The tasks in the following sections explain how to implement IPv6 addressing and basic connectivity:

- [Configuring IPv6 Addressing and Enabling IPv6 Routing, page 45](#)
- [Defining and Using IPv6 General Prefixes, page 50](#)
- [Configuring an Interface to Support the IPv4 and IPv6 Protocol Stacks, page 53](#)
- [Configuring IPv6 ICMP Rate Limiting, page 55](#)
- [Configuring the DRP Extension for Traffic Engineering, page 56](#)
- [Configuring Cisco Express Forwarding and distributed Cisco Express Forwarding Switching for IPv6, page 57](#)
- [Mapping Hostnames to IPv6 Addresses, page 61](#)
- [Mapping IPv6 Addresses to IPv6 ATM and Frame Relay Interfaces, page 63](#)
- [Displaying IPv6 Redirect Messages, page 66](#)

Configuring IPv6 Addressing and Enabling IPv6 Routing

This task explains how to assign IPv6 addresses to individual router interfaces and enable the forwarding of IPv6 traffic globally on the router. By default, IPv6 addresses are not configured and IPv6 routing is disabled.



Note

The *ipv6-address* argument in the **ipv6 address** command must be in the form documented in RFC 2373 where the address is specified in hexadecimal using 16-bit values between colons.

The *ipv6-prefix* argument in the **ipv6 address** command must be in the form documented in RFC 2373 where the address is specified in hexadecimal using 16-bit values between colons.

The *prefix-length* keyword and argument in the **ipv6 address** command is a decimal value that indicates how many of the high-order contiguous bits of the address comprise the prefix (the network portion of the address) A slash mark must precede the decimal value.

IPv6 Multicast Groups

An IPv6 address must be configured on an interface for the interface to forward IPv6 traffic. Configuring a site-local or global IPv6 address on an interface automatically configures a link-local address and activates IPv6 for that interface. Additionally, the configured interface automatically joins the following required multicast groups for that link:

- Solicited-node multicast group FF02:0:0:0:1:FF00::/104 for each unicast and anycast address assigned to the interface
- All-nodes link-local multicast group FF02::1
- All-routers link-local multicast group FF02::2



Note The solicited-node multicast address is used in the neighbor discovery process.

Restrictions

In Cisco IOS Release 12.2(4)T or later releases, Cisco IOS Release 12.0(21)ST, and Cisco IOS Release 12.0(22)S or later releases, the **ipv6 address** or **ipv6 address eui-64** command can be used to configure multiple IPv6 global and site-local addresses within the same prefix on an interface. Multiple IPv6 link-local addresses on an interface are not supported.

Prior to Cisco IOS Releases 12.2(4)T, 12.0(21)ST, and 12.0(22)S, the Cisco IOS command-line interface (CLI) displays the following error message when multiple IPv6 addresses within the same prefix on an interface are configured:

```
Prefix <prefix-number> already assigned to <interface-type>
```

SUMMARY STEPS

1. **enable**
2. **configure terminal**
3. **interface** *type number*
4. **ipv6 address** *ipv6-prefix/prefix-length eui-64*
or
ipv6 address *ipv6-address/prefix-length link-local*
or
ipv6 address *ipv6-prefix/prefix-length anycast*
or
ipv6 enable
5. **exit**
6. **ipv6 unicast-routing**

DETAILED STEPS

	Command or Action	Purpose
Step 1	<p>enable</p> <p>Example: Router> enable</p>	<p>Enables privileged EXEC mode.</p> <ul style="list-style-type: none"> Enter your password if prompted.
Step 2	<p>configure terminal</p> <p>Example: Router# configure terminal</p>	<p>Enters global configuration mode.</p>
Step 3	<p>interface <i>type number</i></p> <p>Example: Router(config)# interface ethernet 0/0</p>	<p>Specifies an interface type and number, and places the router in interface configuration mode.</p>
Step 4	<p>ipv6 address <i>ipv6-prefix/prefix-length eui-64</i> or ipv6 address <i>ipv6-address/prefix-length link-local</i> or ipv6 address <i>ipv6-prefix/prefix-length anycast</i> or ipv6 enable</p> <p>Example: Router(config-if)# ipv6 address 2001:0DB8:0:1::/64 eui-64 or Example: Router(config-if)# ipv6 address FE80::260:3EFF:FE11:6770 link-local or Example: Router(config-if) ipv6 address 2001:0DB8:1:1:FFFF:FFFF:FFFF:FFFE/64 anycast or Example: Router(config-if)# ipv6 enable</p>	<p>Specifies an IPv6 network assigned to the interface and enables IPv6 processing on the interface.</p> <p>or</p> <p>Specifies an IPv6 address assigned to the interface and enables IPv6 processing on the interface.</p> <p>or</p> <p>Automatically configures an IPv6 link-local address on the interface while also enabling the interface for IPv6 processing. The link-local address can be used only to communicate with nodes on the same link.</p> <ul style="list-style-type: none"> Specifying the ipv6 address eui-64 command configures site-local and global IPv6 addresses with an interface identifier (ID) in the low-order 64 bits of the IPv6 address. Only the 64-bit network prefix for the address needs to be specified; the last 64 bits are automatically computed from the interface ID. Specifying the ipv6 address link-local command configures a link-local address on the interface that is used instead of the link-local address that is automatically configured when IPv6 is enabled on the interface. Specifying the ipv6 address anycast command adds an IPv6 anycast address.

	Command or Action	Purpose
Step 5	<code>exit</code> Example: Router(config-if)# <code>exit</code>	Exits interface configuration mode, and returns the router to global configuration mode.
Step 6	<code>ipv6 unicast-routing</code> Example: Router(config)# <code>ipv6 unicast-routing</code>	Enables the forwarding of IPv6 unicast datagrams.

Enabling an HSRP Group for IPv6 Operation

If an IPv6 address is entered, it must be link local. There are no HSRP IPv6 secondary addresses.

Prerequisites

HSRP version 2 must be enabled on an interface before HSRP IPv6 can be configured.

The following tasks describe how to enable and verify an HSRP group for IPv6:

- [Enabling HSRP Version 2, page 48](#)
- [Enabling and Verifying an HSRP Group for IPv6 Operation, page 49](#)

Enabling HSRP Version 2

The following task describes how to enable HSRP version 2 on an interface before HSRP IPv6 can be configured.

SUMMARY STEPS

1. `enable`
2. `configure terminal`
3. `interface type number`
4. `standby version {1 | 2}`

DETAILED STEPS

	Command or Action	Purpose
Step 1	<code>enable</code> Example: Router> <code>enable</code>	Enables privileged EXEC mode. <ul style="list-style-type: none"> • Enter your password if prompted.
Step 2	<code>configure terminal</code> Example: Router# <code>configure terminal</code>	Enters global configuration mode.

	Command or Action	Purpose
Step 3	interface <i>type number</i> Example: Router(config)# interface ethernet 0/0	Specifies an interface type and number, and places the router in interface configuration mode.
Step 4	standby version {1 2} Example: Router (config-if)# standby version 2	Changes the version of the HSRP. Version 1 is the default.

Enabling and Verifying an HSRP Group for IPv6 Operation

In this task, when you enter the **standby ipv6** command, a link-local address is generated from the link-local prefix, and a modified EUI-64 format interface identifier is generated in which the EUI-64 interface identifier is created from the relevant HSRP virtual MAC address.

The following task describes how to enable an HSRP group for IPv6 operation and verify HSRP information.

SUMMARY STEPS

1. **enable**
2. **configure terminal**
3. **interface** *type number*
4. **standby** [*group-number*] **ipv6** {*link-local-address* | **autoconfig**}
5. **standby** [*group-number*] **preempt** [**delay**{*minimum seconds* | **reload** *seconds* | **sync** *seconds*}]
6. **standby** [*group-number*] **priority** *priority*
7. **exit**
8. **exit**
9. **show standby** [*type number* [*group*]] [**all** | **brief**]
10. **show ipv6 interface** [**brief**] [*interface-type interface-number*] [**prefix**]

DETAILED STEPS

	Command or Action	Purpose
Step 1	enable Example: Router> enable	Enables privileged EXEC mode. <ul style="list-style-type: none"> • Enter your password if prompted.
Step 2	configure terminal Example: Router# configure terminal	Enters global configuration mode.

	Command or Action	Purpose
Step 3	interface <i>type number</i> Example: Router(config)# interface ethernet 0/0	Specifies an interface type and number, and places the router in interface configuration mode.
Step 4	standby [<i>group-number</i>] ipv6 { <i>link-local-address</i> autoconfig } Example: Router(config-if)# standby 1 ipv6 autoconfig	Activates the HSRP in IPv6.
Step 5	standby [<i>group-number</i>] preempt [delay { <i>minimum seconds</i> reload <i>seconds</i> sync <i>seconds</i> }] Example: Router(config-if)# standby 1 preempt	Configures HSRP preemption and preemption delay.
Step 6	standby [<i>group-number</i>] priority <i>priority</i> Example: Router(config-if)# standby 1 priority 110	Configures HSRP priority.
Step 7	exit Example: Router(config-if)# exit	Exits interface configuration mode, and returns the router to global configuration mode.
Step 8	exit Example: Router(config-if)# exit	Exits global configuration mode, and returns the router to privileged EXEC mode.
Step 9	show standby [<i>type number [group]</i>] [all brief] Example: Router# show standby	Displays HSRP information.
Step 10	show ipv6 interface [brief] [<i>interface-type interface-number</i>] [prefix] Example: Router# show ipv6 interface ethernet 0/0	Displays the usability status of interfaces configured for IPv6.

Defining and Using IPv6 General Prefixes

General prefixes can be defined in several ways:

- Manually
- Based on a 6to4 interface
- Dynamically, from a prefix received by a DHCP for IPv6 prefix delegation client

More specific prefixes, based on a general prefix, can be used when configuring IPv6 on an interface.

The following tasks describe how to define and use IPv6 general prefixes:

- [Defining a General Prefix Manually, page 51](#)
- [Defining a General Prefix Based on a 6to4 Interface, page 51](#)
- [Defining a General Prefix with the DHCP for IPv6 Prefix Delegation Client Function, page 52](#)
- [Using a General Prefix in IPv6, page 52](#)

Defining a General Prefix Manually

The following task describes how to define a general prefix manually.

SUMMARY STEPS

1. **enable**
2. **configure terminal**
3. **ipv6 general-prefix** *prefix-name* [*ipv6-prefix/prefix-length*] [**6to4** *interface-type interface-number*]

DETAILED STEPS

	Command or Action	Purpose
Step 1	enable Example: Router> enable	Enables privileged EXEC mode. <ul style="list-style-type: none"> • Enter your password if prompted.
Step 2	configure terminal Example: Router# configure terminal	Enters global configuration mode.
Step 3	ipv6 general-prefix <i>prefix-name</i> { <i>ipv6-prefix/prefix-length</i> 6to4 <i>interface-type interface-number</i> } Example: Router(config)# ipv6 general-prefix my-prefix 2001:0DB8:2222::/48	Defines a general prefix for an IPv6 address. When defining a general prefix manually, specify both the <i>ipv6-prefix</i> and <i>lprefix-length</i> arguments.

Defining a General Prefix Based on a 6to4 Interface

The following task describes how to define a general prefix based on a 6to4 interface.

SUMMARY STEPS

1. **enable**
2. **configure terminal**
3. **ipv6 general-prefix** *prefix-name* [*ipv6-prefix/prefix-length*] [**6to4** *interface-type interface-number*]

DETAILED STEPS

	Command or Action	Purpose
Step 1	enable Example: Router> enable	Enables privileged EXEC mode. <ul style="list-style-type: none"> Enter your password if prompted.
Step 2	configure terminal Example: Router# configure terminal	Enters global configuration mode.
Step 3	ipv6 general-prefix <i>prefix-name</i> { <i>ipv6-prefix/prefix-length</i> 6to4 <i>interface-type interface-number</i> } Example: Router(config)# ipv6 general-prefix my-prefix 6to4 ethernet 0	Defines a general prefix for an IPv6 address. When defining a general prefix based on a 6to4 interface, specify the 6to4 keyword and the <i>interface-type interface-number</i> arguments. When defining a general prefix based on an interface used for 6to4 tunneling, the general prefix will be of the form 2001:a.b.c.d::/48, where “a.b.c.d” is the IPv4 address of the interface referenced.

Defining a General Prefix with the DHCP for IPv6 Prefix Delegation Client Function

You can define a general prefix dynamically using the DHCP for IPv6 prefix delegation client function. For information on how to perform this task, see the *Implementing DHCP for IPv6* module.

Using a General Prefix in IPv6

The following task describes how to use a general prefix in IPv6.

SUMMARY STEPS

- enable**
- configure terminal**
- interface** *type number*
- ipv6 address** { *ipv6-address/prefix-length* | *prefix-name sub-bits/prefix-length* }

DETAILED STEPS

	Command or Action	Purpose
Step 1	<p>enable</p> <p>Example: Router> enable</p>	<p>Enables privileged EXEC mode.</p> <ul style="list-style-type: none"> • Enter your password if prompted.
Step 2	<p>configure terminal</p> <p>Example: Router# configure terminal</p>	<p>Enters global configuration mode.</p>
Step 3	<p>interface <i>type number</i></p> <p>Example: Router(config)# interface ethernet 0/0</p>	<p>Specifies an interface type and number, and places the router in interface configuration mode.</p>
Step 4	<p>ipv6 address {<i>ipv6-address/prefix-length</i> <i>prefix-name sub-bits/prefix-length</i>}</p> <p>Example: Router(config-if) ipv6 address my-prefix 2001:0DB8:0:7272::/64</p>	<p>Configures an IPv6 prefix name for an IPv6 address and enables IPv6 processing on the interface.</p>

Configuring an Interface to Support the IPv4 and IPv6 Protocol Stacks

When an interface in a Cisco networking device is configured with both an IPv4 and an IPv6 address, the interface forwards both IPv4 and IPv6 traffic—the interface can send and receive data on both IPv4 and IPv6 networks. To configure an interface in a Cisco networking device to support both the IPv4 and IPv6 protocol stacks, use the following commands.

SUMMARY STEPS

1. **enable**
2. **configure terminal**
3. **ipv6 unicast-routing**
4. **interface** *type number*
5. **ip address** *ip-address mask* [secondary]
6. **ipv6 address** *ipv6-prefix/prefix-length* [eui-64]

DETAILED STEPS

	Command	Purpose
Step 1	enable Example: Router> enable	Enables privileged EXEC mode. <ul style="list-style-type: none"> Enter your password if prompted.
Step 2	configure terminal Example: Router# configure terminal	Enters global configuration mode.
Step 3	ipv6 unicast-routing Example: Router(config)# ipv6 unicast routing	Enables the forwarding of IPv6 unicast datagrams.
Step 4	interface <i>type number</i> Example: Router(config)# interface ethernet 0	Specifies the interface type and number, and enters interface configuration mode.
Step 5	ip address <i>ip-address mask</i> [secondary] Example: Router(config-if)# ip address 192.168.99.1 255.255.255.0	Specifies a primary or secondary IPv4 address for an interface. See the “IP Addressing” section in the <i>Cisco IOS IP Addressing Services Configuration Guide</i> , Release 12.4, for information on configuring IPv4 addresses.
Step 6	ipv6 address <i>ipv6-prefix/prefix-length</i> [eui-64] Example: Router(config-if)# ipv6 address 2001:0DB8:c18:1::3/64	Specifies the IPv6 network assigned to the interface and enables IPv6 processing on the interface. Note See the “ Configuring IPv6 Addressing and Enabling IPv6 Routing ” section for more information on configuring IPv6 addresses.

Configuring Syslog over IPv6

This task explains how to configure syslog over IPv6.

SUMMARY STEPS

- enable**
- configure terminal**
- logging host** *{{ ip-address | hostname } | { ipv6 ipv6-address | hostname } }* [**transport** {**udp** [**port** *port-number*] | **tcp** [**port** *port-number*] [**audit**] }] [**xml** | **filtered** [**stream** *stream-id*]] [**alarm** [*severity*]]

DETAILED STEPS

	Command	Purpose
Step 1	enable Example: Router> enable	Enables privileged EXEC mode. • Enter your password if prompted.
Step 2	configure terminal Example: Router# configure terminal	Enters global configuration mode.
Step 3	logging host {{ip-address hostname} {ipv6 ipv6-address hostname}} [transport {udp [port port-number] tcp [port port-number] [audit]}] [xml filtered [stream stream-id]] [alarm [severity]] Example: Router(config)# logging host ipv6 AAAA:BBBB:CCCC:DDDD::FFFF	Logs system messages and debug output to a remote host.

Configuring IPv6 ICMP Rate Limiting

This task explains how to customize IPv6 ICMP rate limiting.

IPv6 ICMP Rate Limiting

In Cisco IOS Release 12.2(8)T or later releases, the IPv6 ICMP rate limiting feature implements a token bucket algorithm for limiting the rate at which IPv6 ICMP error messages are sent out on the network. The initial implementation of IPv6 ICMP rate limiting defined a fixed interval between error messages, but some applications, such as traceroute, often require replies to a group of requests sent in rapid succession. The fixed interval between error messages is not flexible enough to work with applications such as traceroute and can cause the application to fail. Implementing a token bucket scheme allows a number of tokens—representing the ability to send one error message each—to be stored in a virtual bucket. The maximum number of tokens allowed in the bucket can be specified, and for every error message to be sent, one token is removed from the bucket. If a series of error messages is generated, error messages can be sent until the bucket is empty. When the bucket is empty of tokens, IPv6 ICMP error messages are not sent until a new token is placed in the bucket. The token bucket algorithm does not increase the average rate limiting time interval, and it is more flexible than the fixed time interval scheme.

SUMMARY STEPS

1. **enable**
2. **configure terminal**
3. **ipv6 icmp error-interval** *milliseconds* [*bucketsize*]

DETAILED STEPS

	Command or Action	Purpose
Step 1	enable Example: Router> enable	Enables privileged EXEC mode. <ul style="list-style-type: none"> • Enter your password if prompted.
Step 2	configure terminal Example: Router# configure terminal	Enters global configuration mode.
Step 3	ipv6 icmp error-interval <i>milliseconds</i> [<i>bucketsize</i>] Example: Router(config)# ipv6 icmp error-interval 50 20	Configures the interval and bucket size for IPv6 ICMP error messages. <ul style="list-style-type: none"> • The <i>milliseconds</i> argument specifies the interval between tokens being added to the bucket. • The optional <i>bucketsize</i> argument defines the maximum number of tokens stored in the bucket.

Configuring the DRP Extension for Traffic Engineering

This task describes how to configure the DRP extension to RAs in order to signal the preference value of a default router.

SUMMARY STEPS

1. **enable**
2. **configure terminal**
3. **interface** *type number*
4. **ipv6 nd router-preference** {**high** | **medium** | **low**}

DETAILED STEPS

	Command or Action	Purpose
Step 1	enable Example: Router> enable	Enables privileged EXEC mode. <ul style="list-style-type: none"> • Enter your password if prompted.
Step 2	configure terminal Example: Router# configure terminal	Enters global configuration mode.

	Command or Action	Purpose
Step 3	<pre>interface <i>type number</i></pre> <p>Example: Router(config)# interface ethernet 0</p>	Specifies the interface type and number, and enters interface configuration mode.
Step 4	<pre>ipv6 nd router-preference {high medium low}</pre> <p>Example: Router(config-if)# ipv6 nd router-preference high</p>	Configures a DRP for a router on a specific interface

Configuring Cisco Express Forwarding and distributed Cisco Express Forwarding Switching for IPv6

The following tasks explain how to configure Cisco Express Forwarding and distributed Cisco Express Forwarding switching for IPv6:

- [Configuring Cisco Express Forwarding Switching on Distributed and Nondistributed Architecture Platforms, page 57](#)
- [Configuring Unicast RPF, page 60](#)

Configuring Cisco Express Forwarding Switching on Distributed and Nondistributed Architecture Platforms

Cisco Express Forwarding is designed for nondistributed architecture platforms, such as the Cisco 7200 series routers. Distributed Cisco Express Forwarding is designed for distributed architecture platforms, such as the Cisco 12000 series Internet routers or the Cisco 7500 series routers. Nondistributed platforms do not support distributed Cisco Express Forwarding; however, some distributed platforms, such as the Cisco 7500 series routers, support both Cisco Express Forwarding and distributed Cisco Express Forwarding.

When Cisco Express Forwarding is configured on Cisco 7500 series routers, Cisco Express Forwarding switching is performed by the RP; when distributed Cisco Express Forwarding is configured, Cisco Express Forwarding switching is performed by the line cards. By default, the Cisco 12000 series Internet routers support only distributed Cisco Express Forwarding (Cisco Express Forwarding switching is performed by the line cards).

Prerequisites

To enable the router to forward Cisco Express Forwarding and distributed Cisco Express Forwarding traffic, use the **ipv6 unicast-routing** command to configure the forwarding of IPv6 unicast datagrams globally on the router, and use the **ipv6 address** command to configure IPv6 address and IPv6 processing on an interface.

You must enable Cisco Express Forwarding for IPv4 globally on the router by using the **ip cef** command before enabling Cisco Express Forwarding for IPv6 globally on the router.

You must enable distributed Cisco Express Forwarding for IPv4 by using the **ip cef distributed** command before enabling distributed Cisco Express Forwarding for IPv6.

Restrictions

The **ipv6 cef** and **ipv6 cef distributed** commands are not supported on the Cisco 12000 series Internet routers because this distributed platform operates only in distributed Cisco Express Forwarding mode.

In Cisco IOS Release 12.0(22)S or later releases, the following restrictions apply to nondistributed and distributed architecture platforms configured for Cisco Express Forwarding and distributed Cisco Express Forwarding:



Note By default, the Cisco 12000 series Internet routers support only distributed Cisco Express Forwarding (Cisco Express Forwarding switching is performed by the line cards).

- IPv6 packets that have global or site-local source and destination addresses are Cisco Express Forwarding-switched or distributed Cisco Express Forwarding-switched.
- IPv6 packets that have link-local source and destination addresses are process-switched.
- IPv6 packets that are tunneled within manually configured IPv6 tunnels are Cisco Express Forwarding-switched.
- Only the following interface and encapsulation types are supported:
 - ATM PVC and ATM LANE
 - Cisco HDLC
 - Ethernet, Fast Ethernet, and Gigabit Ethernet
 - FDDI
 - Frame Relay PVC
 - PPP over Packet over SONET, ISDN, and serial (synchronous and asynchronous) interface types
- The following interface and encapsulation types are *not* supported:
 - HP 100VG-AnyLAN
 - Switched Multimegabit Data Service (SMDS)
 - Token Ring
 - X.25



Note Contact your local Cisco Systems account representative for specific Cisco Express Forwarding and distributed Cisco Express Forwarding hardware restrictions.

SUMMARY STEPS

1. **enable**
2. **configure terminal**
3. **ipv6 cef**
or
ipv6 cef distributed
4. **ipv6 cef accounting [non-recursive | per-prefix | prefix-length]**

DETAILED STEPS

	Command or Action	Purpose
Step 1	<p>enable</p> <p>Example: Router> enable</p>	<p>Enables privileged EXEC mode.</p> <ul style="list-style-type: none"> Enter your password if prompted.
Step 2	<p>configure terminal</p> <p>Example: Router# configure terminal</p>	<p>Enters global configuration mode.</p>
Step 3	<p>ipv6 cef OR ipv6 cef distributed</p> <p>Example: Router(config)# ipv6 cef OR</p> <p>Example: Router(config)# ipv6 cef distributed</p>	<p>Enables Cisco Express Forwarding globally on the router.</p> <p>OR</p> <p>Enables distributed Cisco Express Forwarding globally on the router.</p>
Step 4	<p>ipv6 cef accounting [non-recursive per-prefix prefix-length]</p> <p>Example: Router(config)# ipv6 cef accounting</p>	<p>Enables Cisco Express Forwarding and distributed Cisco Express Forwarding network accounting globally on the router.</p> <ul style="list-style-type: none"> Network accounting for Cisco Express Forwarding and distributed Cisco Express Forwarding enables you to better understand Cisco Express Forwarding traffic patterns within your network by collecting statistics specific to Cisco Express Forwarding and distributed Cisco Express Forwarding traffic. For example, network accounting for Cisco Express Forwarding and distributed Cisco Express Forwarding enables you to collect information such as the number of packets and bytes switched to a destination or the number of packets switched through a destination. The optional per-prefix keyword enables the collection of the number of packets and bytes express forwarded to an IPv6 destination (or IPv6 prefix). The optional prefix-length keyword enables the collection of the number of packets and bytes express forwarded to an IPv6 prefix length. <p>Note When Cisco Express Forwarding is enabled globally on the router, accounting information is collected at the RP; when distributed Cisco Express Forwarding is enabled globally on the router, accounting information is collected at the line cards.</p>

Configuring Unicast RPF

This task explains how to configure unicast RPF.

Prerequisites

To use Unicast RPF, enable Cisco Express Forwarding switching or distributed Cisco Express Forwarding switching in the router. There is no need to configure the input interface for Cisco Express Forwarding switching. As long as Cisco Express Forwarding is running on the router, individual interfaces can be configured with other switching modes.



Note It is very important for Cisco Express Forwarding to be configured globally in the router. Unicast RPF will not work without Cisco Express Forwarding.

Restrictions

Unicast RPF should not be used on interfaces that are internal to the network. Internal interfaces are likely to have routing asymmetry, meaning that there are multiple routes to the source of a packet. Unicast RPF should be applied only where there is natural or configured symmetry.

For example, routers at the edge of the network of an ISP are more likely to have symmetrical reverse paths than routers that are in the core of the ISP network. Routers that are in the core of the ISP network have no guarantee that the best forwarding path out of the router will be the path selected for packets returning to the router. Therefore, we do not recommend that you apply Unicast RPF where there is a chance of asymmetric routing. It is simplest to place Unicast RPF only at the edge of a network or, for an ISP, at the customer edge of the network.

SUMMARY STEPS

1. **enable**
2. **configure terminal**
3. **interface** *type number*
4. **ipv6 verify unicast source reachable-via** {rx | any} [**allow-default**] [**allow-self-ping**] [*access-list-name*]

DETAILED STEPS

	Command or Action	Purpose
Step 1	enable Example: Router> enable	Enables privileged EXEC mode. <ul style="list-style-type: none"> • Enter your password if prompted.
Step 2	configure terminal Example: Router# configure terminal	Enters global configuration mode.

	Command or Action	Purpose
Step 3	<code>interface type number</code> Example: Router(config)# interface atm 0	Specifies an interface type and number, and places the router in interface configuration mode.
Step 4	<code>ipv6 verify unicast source reachable-via {rx any} [allow-default] [allow-self-ping] [access-list-name]</code> Example: Router(config-if)# ipv6 verify unicast source reachable-via any	Verifies that a source address exists in the FIB table and enables Unicast RPF.

Mapping Hostnames to IPv6 Addresses

This task explains how to map hostnames with IPv6 addresses.

Hostname-to-Address Mappings

A *name server* is used to track information associated with domain names. A name server can maintain a database of hostname-to-address mappings. Each name can map to one or more IPv4 addresses, IPv6 addresses, or both address types. In order to use this service to map domain names to IPv6 addresses, you must specify a name server and enable the DNS—the global naming scheme of the Internet that uniquely identifies network devices.

The Cisco IOS software maintains a cache of hostname-to-address mappings for use by the **connect**, **telnet**, and **ping** commands, related Telnet support operations, and many other commands that generate command output. This cache speeds the conversion of names to addresses.

Similar to IPv4, IPv6 uses a naming scheme that allows a network device to be identified by its location within a hierarchical name space that provides for domains. Domain names are joined with periods (.) as the delimiting characters. For example, Cisco is a commercial organization that is identified by a *com* domain name, so its domain name is *cisco.com*. A specific device in this domain, the FTP server, for example, is identified as *ftp.cisco.com*.

SUMMARY STEPS

1. **enable**
2. **configure terminal**
3. **ipv6 host name [port] ipv6-address1 [ipv6-address2...ipv6-address4]**
4. **ip domain name [vrf vrf-name] name**
or
ip domain list [vrf vrf-name] name
5. **ip name-server [vrf vrf-name] server-address1 [server-address2...server-address6]**
6. **ip domain-lookup**

DETAILED STEPS

	Command or Action	Purpose
Step 1	<pre>enable</pre> <p>Example: Router> enable </p>	<p>Enables privileged EXEC mode.</p> <ul style="list-style-type: none"> Enter your password if prompted.
Step 2	<pre>configure terminal</pre> <p>Example: Router# configure terminal </p>	<p>Enters global configuration mode.</p>
Step 3	<pre>ipv6 host name [port] ipv6-address1 [ipv6-address2...ipv6-address4]</pre> <p>Example: Router(config)# ipv6 host cisco-sj 2001:0DB8:20:1::12 </p>	<p>Defines a static hostname-to-address mapping in the hostname cache.</p> <ul style="list-style-type: none"> Typically, it is easier to refer to network devices by symbolic names rather than numerical addresses (services such as Telnet can use hostnames or addresses). Hostnames and IPv6 addresses can be associated with one another through static or dynamic means. Manually assigning hostnames to addresses is useful when dynamic mapping is not available.
Step 4	<pre>ip domain name [vrf vrf-name] name</pre> <p>or</p> <pre>ip domain list [vrf vrf-name] name</pre> <p>Example: Router(config)# ip domain-name cisco.com</p> <p>or</p> <p>Example: Router(config)# ip domain list cisco1.com</p>	<p>(Optional) Defines a default domain name that the Cisco IOS software will use to complete unqualified hostnames.</p> <p>or</p> <p>(Optional) Defines a list of default domain names to complete unqualified hostnames.</p> <ul style="list-style-type: none"> You can specify a default domain name that the Cisco IOS software will use to complete domain name requests. You can specify either a single domain name or a list of domain names. Any hostname that does not contain a complete domain name will have the default domain name you specify appended to it before the name is looked up. <p>Note The ip domain name and ip domain list commands are used to specify default domain names that can be used by both IPv4 and IPv6.</p>

	Command or Action	Purpose
Step 5	<pre>ip name-server [vrf vrf-name] server-address1 [server-address2...server-address6]</pre> <p>Example:</p> <pre>Router(config)# ip name-server 2001:0DB8::250:8bff:fee8:f800 2001:0DB8:0:f004::1</pre>	<p>Specifies one or more hosts that supply name information.</p> <ul style="list-style-type: none"> Specifies one or more hosts (up to six) that can function as a name server to supply name information for DNS. <p>Note The <i>server-address</i> argument can be either an IPv4 or IPv6 address.</p>
Step 6	<pre>ip domain-lookup</pre> <p>Example:</p> <pre>Router(config)# ip domain-lookup</pre>	<p>Enables DNS-based address translation.</p> <ul style="list-style-type: none"> DNS is enabled by default.

Mapping IPv6 Addresses to IPv6 ATM and Frame Relay Interfaces

This task explains how to how to map IPv6 addresses to ATM and Frame Relay PVCs. Specifically, the steps in this section explain how to explicitly map IPv6 addresses to the ATM and Frame Relay PVCs used to reach the addresses.



Note

This task shows how to configure both ATM and Frame Relay PVCs. Many of the steps are labeled optional because many networks will require only one type of PVC to be configured. The steps in this section are not applicable to ATM LANE.

IPv6 for Cisco IOS Software Support for Wide-Area Networking Technologies

IPv6 for Cisco IOS software supports wide-area networking technologies such as Cisco HDLC, PPP over Packet over SONET (PoS), ISDN, and serial (synchronous and asynchronous) interface types, ATM PVCs, and Frame Relay PVCs. These technologies function the same in IPv6 as they do in IPv4—IPv6 does not enhance the technologies in any way. However, new commands for mapping protocol (network-layer) addresses to ATM and Frame Relay PVCs have been introduced for IPv6.

IPv6 Addresses and PVCs

Broadcast and multicast are used in LANs to map protocol (network-layer) addresses to the hardware addresses of remote nodes (hosts and routers). Because using broadcast and multicast to map network-layer addresses to hardware addresses in circuit-based WANs such as ATM and Frame Relay networks is difficult to implement, these networks utilize implicit, explicit, and dynamic mappings for the network-layer addresses of remote nodes and the PVCs used to reach the addresses.

Assigning an IPv6 address to an interface by using the **ipv6 address** command defines the IPv6 addresses for the interface and the network that is directly connected to the interface. If only one PVC is terminated on the interface (the interface is a point-to-point interface), there is an implicit mapping between all of the IPv6 addresses on the network and the PVC used to reach the addresses (no additional address mappings are needed). If several PVCs are terminated on the interface (the interface is a point-to-multipoint interface), the **protocol ipv6** command (for ATM networks) or the **frame-relay map ipv6** command (for Frame Relay networks) is used to configure explicit mappings between the IPv6 addresses of the remote nodes and the PVCs used to reach the addresses.

**Note**

Given that IPv6 supports multiple address types, and depending on which applications or protocols are configured on a point-to-multipoint interface, you may need to configure multiple explicit mappings between the IPv6 addresses of the interface and the PVC used to reach the addresses. For example, explicitly mapping both the link-local and global IPv6 address of a point-to-multipoint interface to the PVC that the interface terminates ensures that the Interior Gateway Protocol (IGP) configured on the interface forwards traffic to and from the PVC correctly.

SUMMARY STEPS

1. **enable**
2. **configure terminal**
3. **interface** *type number*
4. **pvc** [*name*] *vpi/vci* [**ces** | **ilmi** | **qsaal** | **smds** | **l2transport**]
5. **protocol ipv6** *ipv6-address* [[**no**] **broadcast**]]
6. **exit**
7. **ipv6 address** *ipv6-address/prefix-length* **link-local**
8. **exit**
9. **interface** *type number*
10. **frame-relay map ipv6** *ipv6-address dlc* [**broadcast**] [**cisco**] [**ietf**] [**payload-compression** {**packet-by-packet** | **frf9 stac** [*hardware-options*] | **data-stream stac** [*hardware-options*]}]
11. **ipv6 address** *ipv6-address/prefix-length* **link-local**

DETAILED STEPS

	Command or Action	Purpose
Step 1	enable Example: Router> enable	Enables privileged EXEC mode. <ul style="list-style-type: none"> • Enter your password if prompted.
Step 2	configure terminal Example: Router# configure terminal	Enters global configuration mode.
Step 3	interface <i>type number</i> Example: Router(config)# interface atm 0	Specifies an interface type and number, and places the router in interface configuration mode.
Step 4	pvc [<i>name</i>] <i>vpi/vci</i> [ces ilmi qsaal smds l2transport] Example: Router(config-if)# pvc 1/32	(Optional) Creates or assigns a name to an ATM PVC and places the router in ATM VC configuration mode.

	Command or Action	Purpose
Step 5	<p>protocol ipv6 <i>ipv6-address</i> [[no] broadcast]</p> <p>Example: Router(config-if-atm-vc)# protocol ipv6 2001:0DB8:2222:1003::45</p>	<p>(Optional) Maps the IPv6 address of a remote node to the PVC used to reach the address.</p> <ul style="list-style-type: none"> The <i>ipv6-address</i> argument must be in the form documented in RFC 2373 where the address is specified in hexadecimal using 16-bit values between colons. The optional [no] broadcast keywords indicate whether the map entry should be used when IPv6 multicast packets (not broadcast packets) are sent to the interface. Pseudobroadcasting is supported. The [no] broadcast keywords in the protocol ipv6 command take precedence over the broadcast command configured on the same ATM PVC.
Step 6	<p>exit</p> <p>Example: Router(config-if-atm-vc)# exit</p>	<p>Exits ATM VC configuration mode, and returns the router to interface configuration mode.</p>
Step 7	<p>ipv6 address <i>ipv6-address/prefix-length</i> link-local</p> <p>Example: Router(config-if)# ipv6 address 2001:0DB8:2222:1003::72/64 link-local</p>	<p>Specifies an IPv6 network assigned to the interface and enables IPv6 processing on the interface.</p> <ul style="list-style-type: none"> In the context of this task, a link-local address of the node at the other end of the link is required for the Interior Gateway Protocol (IGP) used in the network. Specifying the ipv6 address link-local command configures a link-local address on the interface that is used instead of the link-local address that is automatically configured when IPv6 is enabled on the interface.
Step 8	<p>exit</p> <p>Example: Router(config-if)# exit</p>	<p>Exits interface configuration mode, and returns the router to global configuration mode.</p>
Step 9	<p>interface <i>type number</i></p> <p>Example: Router(config)# interface serial 3</p>	<p>Specifies an interface type and number, and places the router in interface configuration mode.</p>

Command or Action	Purpose
<p>Step 10</p> <pre>frame-relay map ipv6 ipv6-address dlc1 [broadcast] [cisco] [ietf] [payload-compression {packet-by-packet frf9 stac [hardware-options] data-stream stac [hardware-options]}}</pre> <p>Example:</p> <pre>Router(config-if)# frame-relay map ipv6 FE80::E0:F727:E400:A 17 broadcast</pre>	<p>(Optional) Maps the IPv6 address of a remote node to the data-link connection identifier (DLCI) of the PVC used to reach the address.</p> <ul style="list-style-type: none"> The <i>ipv6-address</i> argument must be in the form documented in RFC 2373 where the address is specified in hexadecimal using 16-bit values between colons. The <i>dlci</i> argument specifies the DLCI number used to reach the specified IPv6 address on the interface. The acceptable range is from 16 to 1007. The optional broadcast keyword specifies that IPv6 multicast packets (not broadcast packets) should be forwarded to this IPv6 address when multicast is not enabled. (See the frame-relay multicast-dlci command for information on defining a multicast DLCI.) The optional cisco keyword specifies the Cisco form of Frame Relay encapsulation. The optional ietf keyword specifies the IETF form of Frame Relay encapsulation. The optional payload-compression keyword specifies payload compression. (See the frame-relay map ipv6 command for subordinate keywords and arguments related to the payload-compression keyword.)
<p>Step 11</p> <pre>ipv6 address ipv6-address/prefix-length link-local</pre> <p>Example:</p> <pre>Router(config-if)# ipv6 address 2001:0DB8:2222:1044::46/64 link-local</pre>	<p>Specifies an IPv6 network assigned to the interface and enables IPv6 processing on the interface.</p> <ul style="list-style-type: none"> In the context of this task, a link-local address of the node at the other end of the link is required for the IGP used in the network. Specifying the ipv6 address link-local command configures a link-local address on the interface that is used instead of the link-local address that is automatically configured when IPv6 is enabled on the interface.

Displaying IPv6 Redirect Messages

This task explains how to display IPv6 redirect messages. The commands shown are optional and can be entered in any order.

IPv6 Redirect Messages

The IPv6 Redirect Messages feature enables a router to send ICMP IPv6 neighbor redirect messages to inform hosts of better first hop nodes (routers or hosts) on the path to a destination.

There are no configuration tasks for the IPv6 Redirect Messages feature. The sending of IPv6 redirect messages is enabled by default. Use the **no ipv6 redirects** command to disable the sending of IPv6 redirect messages on an interface. Use the **ipv6 redirects** command to reenables the sending of IPv6 redirect messages if the Cisco IOS software is forced to resend a packet through the same interface on which the packet was received.

To verify whether the sending of IPv6 redirect messages is enabled on an interface, enter the **show ipv6 interface** command.

SUMMARY STEPS

1. **enable**
2. **show ipv6 interface [brief] [interface-type interface-number] [prefix]**
3. **show ipv6 neighbors [interface-type interface-number | ipv6-address | ipv6-hostname | statistics]**
4. **show ipv6 route [ipv6-address | ipv6-prefix/prefix-length | protocol | interface-type interface-number]**
5. **show ipv6 traffic**
6. **show frame-relay map [interface type number] [dlci]**
7. **show atm map**
8. **show hosts [vrf vrf-name | all | hostname | summary]**
9. **enable**
10. **show running-config**

DETAILED STEPS

	Command or Action	Purpose
Step 1	enable Example: Router# enable	Enables privileged EXEC mode. <ul style="list-style-type: none"> • Enter your password if prompted.
Step 2	show ipv6 interface [brief] [interface-type interface-number] [prefix] Example: Router# show ipv6 interface ethernet 0	Displays the usability status of interfaces configured for IPv6. <ul style="list-style-type: none"> • Displays information about the status of IPv6 neighbor redirect messages, IPv6 neighbor discovery messages, and stateless autoconfiguration.
Step 3	show ipv6 neighbors [interface-type interface-number ipv6-address ipv6-hostname statistics] Example: Router# show ipv6 neighbors ethernet 2	Displays IPv6 neighbor discovery cache information.

	Command or Action	Purpose
Step 4	<pre>show ipv6 route [ipv6-address ipv6-prefix/prefix-length protocol interface-type interface-number]</pre> <p>Example: Router# show ipv6 route</p>	(Optional) Displays the current contents of the IPv6 routing table.
Step 5	<pre>show ipv6 traffic</pre> <p>Example: Router# show ipv6 traffic</p>	(Optional) Displays statistics about IPv6 traffic.
Step 6	<pre>show frame-relay map [interface type number] [dlci]</pre> <p>Example: Router# show frame-relay map</p>	Displays the current map entries and information about the Frame Relay connections.
Step 7	<pre>show atm map</pre> <p>Example: Router# show atm map</p>	Displays the list of all configured ATM static maps to remote hosts on an ATM network and on ATM bundle maps.
Step 8	<pre>show hosts [vrf vrf-name all hostname summary]</pre> <p>Example: Router# show hosts</p>	Displays the default domain name, the style of name lookup service, a list of name server hosts, and the cached list of hostnames and addresses.
Step 9	<pre>enable</pre> <p>Example: Router> enable</p>	Enables privileged EXEC mode. <ul style="list-style-type: none"> Enter your password if prompted.
Step 10	<pre>show running-config</pre> <p>Example: Router# show running-config</p>	Displays the current configuration running on the router.

Examples

This section provides the following output examples:

- [Sample Output for the show ipv6 interface Command](#)
- [Sample Output for the show ipv6 neighbors Command](#)
- [Sample Output for the show ipv6 route Command](#)
- [Sample Output for the show ipv6 traffic Command](#)
- [Sample Output for the show frame-relay map Command](#)
- [Sample Output for the show atm map Command](#)
- [Sample Output for the show hosts Command](#)
- [Sample Output for the show running-config Command](#)

Sample Output for the show ipv6 interface Command

In the following example, the **show ipv6 interface** command is used to verify that IPv6 addresses are configured correctly for Ethernet interface 0. Information is also displayed about the status of IPv6 neighbor redirect messages, IPv6 neighbor discovery messages, and stateless autoconfiguration.

```
Router# show ipv6 interface ethernet 0
```

```
Ethernet0 is up, line protocol is up
 IPv6 is stalled, link-local address is FE80::1
 Global unicast address(es):
   2001:0DB8:2000::1, subnet is 2001:0DB8:2000::/64
   2001:0DB8:3000::1, subnet is 2001:0DB8:3000::/64
 Joined group address(es):
   FF02::1
   FF02::2
   FF02::1:FF00:1
 MTU is 1500 bytes
 ICMP error messages limited to one every 100 milliseconds
 ICMP redirects are enabled
 ND DAD is enabled, number of DAD attempts: 1
 ND reachable time is 30000 milliseconds
 ND advertised reachable time is 0 milliseconds
 ND advertised retransmit interval is 0 milliseconds
 ND router advertisements are sent every 200 seconds
 ND router advertisements live for 1800 seconds
 Hosts use stateless autoconfig for addresses.
```

Sample Output for the show ipv6 neighbors Command

In the following example, the **show ipv6 neighbors** command is used to display IPv6 neighbor discovery cache information. A hyphen (-) in the Age field of the command output indicates a static entry. The following example displays IPv6 neighbor discovery cache information for Ethernet interface 2:

```
Router# show ipv6 neighbors ethernet 2
```

IPv6 Address	Age	Link-layer Addr	State	Interface
2001:0DB8:0:4::2	0	0003.a0d6.141e	REACH	Ethernet2
FE80::XXXX:A0FF:FED6:141E	0	0003.a0d6.141e	REACH	Ethernet2
2001:0DB8:1::45a	-	0002.7d1a.9472	REACH	Ethernet2

Sample Output for the show ipv6 route Command

When the *ipv6-address* or *ipv6-prefix/prefix-length* argument is specified, only route information for that address or network is displayed. The following is sample output from the **show ipv6 route** command when entered with the IPv6 prefix 2001:0DB8::/35:

```
Router# show ipv6 route 2001:0DB8::/35
```

```
IPv6 Routing Table - 261 entries
Codes: C - Connected, L - Local, S - Static, R - RIP, B - BGP
I1 - ISIS L1, I2 - ISIS L2, IA - ISIS interarea

B 2001:0DB8::/35 [20/3]
  via FE80::60:5C59:9E00:16, Tunnel1
```

Sample Output for the show ipv6 traffic Command

In the following example, the **show ipv6 traffic** command is used to display ICMP rate-limited counters:

```
Router# show ipv6 traffic

ICMP statistics:
  Rcvd: 188 input, 0 checksum errors, 0 too short
        0 unknown info type, 0 unknown error type
  unreachable: 0 routing, 0 admin, 0 neighbor, 0 address, 0 port
  parameter: 0 error, 0 header, 0 option
  0 hopcount expired, 0 reassembly timeout, 0 too big
  0 echo request, 0 echo reply
  0 group query, 0 group report, 0 group reduce
  1 router solicit, 175 router advert, 0 redirects
  0 neighbor solicit, 12 neighbor advert
  Sent: 7376 output, 56 rate-limited
        unreachable: 0 routing, 15 admin, 0 neighbor, 0 address, 0 port
        parameter: 0 error, 0 header, 0 option
        0 hopcount expired, 0 reassembly timeout, 0 too big
        15 echo request, 0 echo reply
        0 group query, 0 group report, 0 group reduce
        0 router solicit, 7326 router advert, 0 redirects
        2 neighbor solicit, 22 neighbor advert
```

Sample Output for the show frame-relay map Command

In the following example, the **show frame-relay map** command is used to verify that the IPv6 address of a remote node is mapped to the DLCI of the PVC used to reach the address. The following example shows that the link-local and global IPv6 addresses (FE80::E0:F727:E400:A and 2001:0DB8:2222:1044::73; FE80::60:3E47:AC8:8 and 2001.0DB8:2222:1044::72) of two remote nodes are explicitly mapped to DLCI 17 and DLCI 19, respectively. Both DLCI 17 and DLCI 19 are terminated on interface serial 3 of this node; therefore, interface serial 3 of this node is a point-to-multipoint interface.

```
Router# show frame-relay map

Serial3 (up): ipv6 FE80::E0:F727:E400:A dlci 17(0x11,0x410), static,
              broadcast, CISCO, status defined, active
Serial3 (up): ipv6 2001:0DB8:2222:1044::72 dlci 19(0x13,0x430), static,
              CISCO, status defined, active
Serial3 (up): ipv6 2001:0DB8:2222:1044::73 dlci 17(0x11,0x410), static,
              CISCO, status defined, active
Serial3 (up): ipv6 FE80::60:3E47:AC8:8 dlci 19(0x13,0x430), static,
              broadcast, CISCO, status defined, active
```

Sample Output for the show atm map Command

In the following example, the **show atm map** command is used to verify that the IPv6 address of a remote node is mapped to the PVC used to reach the address. The following example shows that the link-local and global IPv6 addresses (FE80::60:3E47:AC8:C and 2001:0DB8:2222:1003::72, respectively) of a remote node are explicitly mapped to PVC 1/32 of ATM interface 0:

```
Router# show atm map

Map list ATM0pvc1 : PERMANENT
ipv6 FE80::60:3E47:AC8:C maps to VC 1, VPI 1, VCI 32, ATM0
, broadcast
ipv6 2001:0DB8:2222:1003::72 maps to VC 1, VPI 1, VCI 32, ATM0
```

Sample Output for the show hosts Command

The state of the name lookup system on the DHCP for IPv6 client can be displayed with the **show hosts** command:

```

Router# show hosts
Default domain is not set
Domain list:verybigcompany.com
Name/address lookup uses domain service
Name servers are 2001:0DB8:A:B::1, 2001:0DB8:3000:3000::42

Codes:UN - unknown, EX - expired, OK - OK, ?? - revalidate
      temp - temporary, perm - permanent
      NA - Not Applicable None - Not defined

Host          Port  Flags      Age Type  Address(es)
sdfasfd      None (temp, UN) 0 IPv6

```

Sample Output for the show running-config Command

In the following example, the **show running-config** command is used to verify that IPv6 processing of packets is enabled globally on the router and on applicable interfaces, and that an IPv6 address is configured on applicable interfaces:

```

Router# show running-config

Building configuration...

Current configuration : 22324 bytes
!
! Last configuration change at 14:59:38 PST Tue Jan 16 2001
! NVRAM config last updated at 04:25:39 PST Tue Jan 16 2001 by bird
!
hostname Router
!
ipv6 unicast-routing
!
interface Ethernet0
  no ip route-cache
  no ip mroute-cache
  no keepalive
  media-type 10BaseT
  ipv6 address 2001:0DB8:0:1::/64 eui-64
!

```

In the following example, the **show running-config** command is used to verify that Cisco Express Forwarding and network accounting for Cisco Express Forwarding have been enabled globally on a nondistributed architecture platform, and that Cisco Express Forwarding has been enabled on an IPv6 interface. The following output shows that both that Cisco Express Forwarding and network accounting for Cisco Express Forwarding have been enabled globally on the router, and that Cisco Express Forwarding has also been enabled on Ethernet interface 0:

```

Router# show running-config

Building configuration...

Current configuration : 22324 bytes
!
! Last configuration change at 14:59:38 PST Tue Jan 16 2001
! NVRAM config last updated at 04:25:39 PST Tue Jan 16 2001 by bird
!
hostname Router
!
ip cef
ipv6 unicast-routing
ipv6 cef
ipv6 cef accounting prefix-length
!

```

```
!
interface Ethernet0
 ip address 10.4.9.11 255.0.0.0
 media-type 10BaseT
 ipv6 address 2001:0DB8:C18:1::/64 eui-64
!
```

In the following example, the **show running-config** command is used to verify that distributed Cisco Express Forwarding and network accounting for distributed Cisco Express Forwarding have been enabled globally on a distributed architecture platform, such as the Cisco 7500 series routers. The following example shows that both distributed Cisco Express Forwarding and network accounting for Cisco Express Forwarding have been enabled globally on the router.

**Note**

Distributed Cisco Express Forwarding is enabled by default on the Cisco 12000 series Internet routers and disabled by default on the Cisco 7500 series routers. Therefore, output from the **show running-config** command on the Cisco 12000 series does not show whether distributed Cisco Express Forwarding is configured globally on the router. The following output is from a Cisco 7500 series router.

```
Router# show running-config
Building configuration...

Current configuration : 22324 bytes
!
! Last configuration change at 14:59:38 PST Tue Jan 16 2001
! NVRAM config last updated at 04:25:39 PST Tue Jan 16 2001 by bird
!
hostname Router
!
ip cef distributed
ipv6 unicast-routing
ipv6 cef distributed
ipv6 cef accounting prefix-length
```

In the following example, the **show running-config** command is used to verify static hostname-to-address mappings, default domain names, and name servers in the hostname cache, and to verify that the DNS service is enabled:

```
Router# show running-config
Building configuration...
!
ipv6 host cisco-sj 2001:0DB8:20:1::12
!
ip domain-name cisco.com
ip domain-lookup
ip name-server 2001:0DB8:C01F:768::1
```

Configuration Examples for Implementing IPv6 Addressing and Basic Connectivity

This section provides the following configuration examples:

- [IPv6 Addressing and IPv6 Routing Configuration: Example, page 73](#)
- [Dual Protocol Stacks Configuration: Example, page 74](#)

- [IPv6 ICMP Rate Limiting Configuration: Example, page 74](#)
- [Cisco Express Forwarding and distributed Cisco Express Forwarding Configuration: Example, page 74](#)
- [Hostname-to-Address Mappings Configuration: Example, page 75](#)
- [IPv6 Address to ATM and Frame Relay PVC Mapping Configuration: Examples, page 75](#)

IPv6 Addressing and IPv6 Routing Configuration: Example

In the following example, IPv6 is enabled on the router with both a link-local address and a global address based on the IPv6 prefix 2001:0DB8:c18:1::/64. The EUI-64 interface ID is used in the low-order 64 bits of both addresses. Output from the **show ipv6 interface** command is included to show how the interface ID (260:3EFF:FE47:1530) is appended to the link-local prefix FE80::/64 of Ethernet interface 0.

```
ipv6 unicast-routing

interface ethernet 0
  ipv6 address 2001:0DB8:c18:1::/64 eui-64

Router# show ipv6 interface ethernet 0

Ethernet0 is up, line protocol is up
IPv6 is enabled, link-local address is FE80::260:3EFF:FE47:1530
Global unicast address(es):
  2001:0DB8:C18:1:260:3EFF:FE47:1530, subnet is 2001:0DB8:C18:1::/64
Joined group address(es):
  FF02::1
  FF02::2
  FF02::1:FF47:1530
  FF02::9
MTU is 1500 bytes
ICMP error messages limited to one every 500 milliseconds
ND reachable time is 30000 milliseconds
ND advertised reachable time is 0 milliseconds
ND advertised retransmit interval is 0 milliseconds
ND router advertisements are sent every 200 seconds
ND router advertisements live for 1800 seconds
Hosts use stateless autoconfig for addresses.
```

In the following example, multiple IPv6 global addresses within the prefix 2001:0DB8::/64 are configured on Ethernet interface 0:

```
interface ethernet 0
  ipv6 address 2001:0DB8::1/64
  ipv6 address 2001:0DB8::/64 eui-64
```



Note

All site-local addresses must be within the same site.

Dual Protocol Stacks Configuration: Example

The following example enables the forwarding of IPv6 unicast datagrams globally on the router and configures Ethernet interface 0 with both an IPv4 address and an IPv6 address:

```
ipv6 unicast-routing

interface Ethernet0
 ip address 192.168.99.1 255.255.255.0
 ipv6 address 2001:0DB8:c18:1::3/64
```

IPv6 ICMP Rate Limiting Configuration: Example

The following example shows an interval of 50 milliseconds and a bucket size of 20 tokens being configured for IPv6 ICMP error messages:

```
ipv6 icmp error-interval 50 20
```

Cisco Express Forwarding and distributed Cisco Express Forwarding Configuration: Example

In the following example, both Cisco Express Forwarding for IPv6 and network accounting for Cisco Express Forwarding for IPv6 have been enabled globally on a nondistributed architecture router, and Cisco Express Forwarding for IPv6 has been enabled on Ethernet interface 0. The example also shows that the forwarding of IPv6 unicast datagrams has been configured globally on the router with the **ipv6 unicast-routing** command, an IPv6 address has been configured on Ethernet interface 0 with the **ipv6 address** command, and Cisco Express Forwarding for IPv4 has been configured globally on the router with the **ip cef** command.

```
ip cef
ipv6 unicast-routing
ipv6 cef
ipv6 cef accounting prefix-length

interface Ethernet0
 ip address 10.4.9.11 255.0.0.0
 media-type 10BaseT
 ipv6 address 2001:0DB8:C18:1::/64 eui-64
```

In the following example, both distributed Cisco Express Forwarding for IPv6 and network accounting for distributed Cisco Express Forwarding for IPv6 have been enabled globally on a distributed architecture router. The forwarding of IPv6 unicast datagrams has been configured globally on the router with the **ipv6 unicast-routing** command and distributed Cisco Express Forwarding for IPv4 has been configured globally on the router with the **ip cef distributed** command.

```
ip cef distributed
ipv6 unicast-routing
ipv6 cef distributed
ipv6 cef accounting prefix-length
```

Hostname-to-Address Mappings Configuration: Example

The following example defines two static hostname-to-address mappings in the hostname cache, establishes a domain list with several alternate domain names to complete unqualified hostnames, specifies host 2001:0DB8::250:8bff:fee8:f800 and host 2001:0DB8:0:f004::1 as the name servers, and reenables the DNS service:

```
ipv6 host cisco-sj 2001:0DB8:700:20:1::12
ipv6 host cisco-hq 2001:0DB8:768::1 2001:0DB8:20:1::22
ip domain list domain1-list.com
ip domain list serviceprovider2-name.com
ip domain list college2-name.edu
ip name-server 2001:0DB8::250:8bff:fee8:f800 2001:0DB8:0:f004::1
ip domain-lookup
```

IPv6 Address to ATM and Frame Relay PVC Mapping Configuration: Examples

This section provides the following IPv6 ATM and Frame Relay PVC mapping configuration examples:

- [IPv6 ATM PVC Mapping Configuration—Point-to-Point Interface: Example](#)
- [IPv6 ATM PVC Mapping Configuration—Point-to-Multipoint Interface: Example](#)
- [IPv6 Frame Relay PVC Mapping Configuration—Point-to-Point Interface: Example](#)
- [IPv6 Frame Relay PVC Mapping Configuration—Point-to-Multipoint Interface: Example](#)

IPv6 ATM PVC Mapping Configuration—Point-to-Point Interface: Example

In the following example, two nodes named Router 1 and Router 2 are connected by a single PVC. The point-to-point subinterface ATM0.132 is used on both nodes to terminate the PVC; therefore, the mapping between the IPv6 addresses of both nodes and the PVC is implicit (no additional mappings are required).

Router 1 Configuration

```
interface ATM 0
  no ip address
!
interface ATM 0.132 point-to-point
  pvc 1/32
  encapsulation aal5snap
!
  ipv6 address 2001:0DB8:2222:1003::72/64
```

Router 2 Configuration

```
interface ATM 0
  no ip address
!
interface ATM 0.132 point-to-point
  pvc 1/32
  encapsulation aal5snap
!
  ipv6 address 2001:0DB8:2222:1003::45/64
```

IPv6 ATM PVC Mapping Configuration—Point-to-Multipoint Interface: Example

In the following example, the same two nodes (Router 1 and Router 2) from the previous example are connected by the same PVC. In this example, however, the point-to-multipoint interface ATM0 is used on both nodes to terminate the PVC; therefore, explicit mappings are required between the link-local and global IPv6 addresses of interface ATM0 on both nodes and the PVC. Additionally, ATM pseudobroadcasts are enabled on the link-local address of interface ATM0 on both nodes. The link-local address specified here is the link-local address of the other end of the PVC.

Router 1 Configuration

```
interface ATM 0
  no ip address
  pvc 1/32
  protocol ipv6 2001:0DB8:2222:1003::45
  protocol ipv6 FE80::60:2FA4:8291:2 broadcast
  encapsulation aal5snap
  !
  ipv6 address 2001:0DB8:2222:1003::72/64
```

Router 2 Configuration

```
interface ATM 0
  no ip address
  pvc 1/32
  protocol ipv6 FE80::60:3E47:AC8:C broadcast
  protocol ipv6 2001:0DB8:2222:1003::72
  encapsulation aal5snap
  !
  ipv6 address 2001:0DB8:2222:1003::45/64
```

IPv6 Frame Relay PVC Mapping Configuration—Point-to-Point Interface: Example

In the following example, three nodes named Router A, Router B, and Router C make up a fully meshed network. Each node is configured with two PVCs, which provide an individual connection to each of the other two nodes. Each PVC is configured on a different point-to-point subinterface, which creates three unique IPv6 networks (2001:0DB8:2222:1017:/64, 2001:0DB8:2222:1018:/64, and 2001:0DB8:2222:1019:/64). Therefore, the mappings between the IPv6 addresses of each node and the DLCI (DLCI 17, 18, and 19) of the PVC used to reach the addresses are implicit (no additional mappings are required).



Note

Given that each PVC in the following example is configured on a different point-to-point subinterface, the configuration in the following example can also be used in a network that is not fully meshed. Additionally, configuring each PVC on a different point-to-point subinterface can help simplify your routing protocol configuration. However, the configuration in the following example requires more than one IPv6 network, whereas configuring each PVC on point-to-multipoint interfaces requires only one IPv6 network.

Router A Configuration

```
interface Serial 3
  encapsulation frame-relay
  !
  interface Serial3.17 point-to-point
  description to Router B
  ipv6 address 2001:0DB8:2222:1017::46/64
  frame-relay interface-dlci 17
```

```

!
interface Serial 3.19 point-to-point
description to Router C
ipv6 address 2001:0DB8:2222:1019::46/64
frame-relay interface-dlci 19

```

Router B Configuration

```

interface Serial 5
encapsulation frame-relay
!
interface Serial5.17 point-to-point
description to Router A
ipv6 address 2001:0DB8:2222:1017::73/64
frame-relay interface-dlci 17
!
interface Serial5.18 point-to-point
description to Router C
ipv6 address 2001:0DB8:2222:1018::73/64
frame-relay interface-dlci 18

```

Router C Configuration

```

interface Serial 0
encapsulation frame-relay
!
interface Serial0.18 point-to-point
description to Router B
ipv6 address 2001:0DB8:2222:1018::72/64
frame-relay interface-dlci 18
!
interface Serial0.19 point-to-point
description to Router A
ipv6 address 2001:0DB8:2222:1019::72/64
frame-relay interface-dlci 19

```

IPv6 Frame Relay PVC Mapping Configuration—Point-to-Multipoint Interface: Example

In the following example, the same three nodes (Router A, Router B, and Router C) from the previous example make up a fully meshed network and each node is configured with two PVCs (which provide an individual connection to each of the other two nodes). However, the two PVCs on each node in the following example are configured on a single interface (serial 3, serial 5, and serial 10, respectively), which makes each interface a point-to-multipoint interface. Therefore, explicit mappings are required between the link-local and global IPv6 addresses of each interface on all three nodes and the DLCI (DLCI 17, 18, and 19) of the PVC used to reach the addresses.

Router A Configuration

```

interface Serial 3
encapsulation frame-relay
ipv6 address 2001:0DB8:2222:1044::46/64
frame-relay map ipv6 FE80::E0:F727:E400:A 17 broadcast
frame-relay map ipv6 FE80::60:3E47:AC8:8 19 broadcast
frame-relay map ipv6 2001:0DB8:2222:1044::72 19
frame-relay map ipv6 2001:0DB8:2222:1044::73 17

```

Router B Configuration

```

interface Serial 5
encapsulation frame-relay
ipv6 address 2001:0DB8:2222:1044::73/64
frame-relay map ipv6 FE80::60:3E59:DA78:C 17 broadcast
frame-relay map ipv6 FE80::60:3E47:AC8:8 18 broadcast
frame-relay map ipv6 2001:0DB8:2222:1044::46 17

```

```
frame-relay map ipv6 2001:0DB8:2222:1044::72 18
```

Router C Configuration

```
interface Serial 10
encapsulation frame-relay
ipv6 address 2001:0DB8:2222:1044::72/64
frame-relay map ipv6 FE80::60:3E59:DA78:C 19 broadcast
frame-relay map ipv6 FE80::E0:F727:E400:A 18 broadcast
frame-relay map ipv6 2001:0DB8:2222:1044::46 19
frame-relay map ipv6 2001:0DB8:2222:1044::73 18
```

Where to Go Next

If you want to implement IPv6 routing protocols, see the *Implementing RIP for IPv6*, *Implementing IS-IS for IPv6*, or *Implementing Multiprotocol BGP for IPv6* module.

Additional References

The following sections provide references related to implementing IPv6 addressing and basic connectivity:

Related Documents

Related Topic	Document Title
IPv6 supported feature list	<i>Start Here: Cisco IOS Software Release Specifics for IPv6 Features</i>
IPv6 commands: complete command syntax, command mode, defaults, usage guidelines, and examples	<i>Cisco IOS IPv6 Command Reference</i>
IPv6 DHCP description and configuration	<i>Implementing DHCP for IPv6</i>
IPv4 addressing configuration tasks	“IP Addressing” section in the <i>Cisco IOS IP Addressing Services Configuration Guide</i> , Release 12.4
IPv4 services configuration tasks	“Configuring IP Services” section in the <i>Cisco IOS IP Application Services Configuration Guide</i> , Release 12.4
IPv4 addressing commands: complete command syntax, command mode, defaults, usage guidelines, and examples	<i>Cisco IOS IP Addressing Services Command Reference</i> , Release 12.4
IPv4 IP services commands: complete command syntax, command mode, defaults, usage guidelines, and examples	<i>Cisco IOS IP Application Services Command Reference, Volume 1 of 4: Addressing and Services</i> , Release 12.4
Configuring HSRP in IPv4	“Configuring HSRP,” <i>Cisco IOS IP Application Services Configuration Guide</i> , Release 12.4
Switching configuration tasks	<i>Cisco IOS Switching Services Configuration Guide</i> , Release 12.4
Switching commands: complete command syntax, command mode, defaults, usage guidelines, and examples	<i>Cisco IOS Switching Services Command Reference</i> , Release 12.4

Related Topic	Document Title
WAN configuration tasks	<i>Cisco IOS Wide-Area Networking Configuration Guide</i> , Release 12.4
WAN commands: complete command syntax, command mode, defaults, usage guidelines, and examples	<i>Cisco IOS Wide-Area Networking Command Reference</i> , Release 12.4

Standards

Standards	Title
No new or modified standards are supported by this feature, and support for existing standards has not been modified by this feature.	—

MIBs

MIBs	MIBs Link
<ul style="list-style-type: none"> CISCO-IP-FORWARD-MIB CISCO-IP-MIB 	To locate and download MIBs for selected platforms, Cisco IOS releases, and feature sets, use Cisco MIB Locator found at the following URL: http://www.cisco.com/go/mibs

RFCs

RFCs	Title
RFC 1981	<i>Path MTU Discovery for IP version 6</i>
RFC 2281	<i>Cisco Hot Standby Router Protocol (HSRP)</i>
RFC 2373	<i>IP Version 6 Addressing Architecture</i>
RFC 2374	<i>An Aggregatable Global Unicast Address Format</i>
RFC 2460	<i>Internet Protocol, Version 6 (IPv6) Specification</i>
RFC 2461	<i>Neighbor Discovery for IP Version 6 (IPv6)</i>
RFC 2462	<i>IPv6 Stateless Address Autoconfiguration</i>
RFC 2463	<i>Internet Control Message Protocol (ICMPv6) for the Internet Protocol Version 6 (IPv6) Specification</i>
RFC 2464	<i>Transmission of IPv6 Packets over Ethernet Networks</i>
RFC 2467	<i>Transmission of IPv6 Packets over FDDI Networks</i>
RFC 2472	<i>IP Version 6 over PPP</i>
RFC 2492	<i>IPv6 over ATM Networks</i>
RFC 2590	<i>Transmission of IPv6 Packets over Frame Relay Networks Specification</i>
RFC 3152	<i>Delegation of IP6.ARPA</i>

■ Additional References

RFCs	Title
RFC 3162	<i>RADIUS and IPv6</i>
RFC 3513	<i>Internet Protocol Version 6 (IPv6) Addressing Architecture</i>
RFC 3596	<i>DNS Extensions to Support IP version 6</i>

Technical Assistance

Description	Link
The Cisco Technical Support & Documentation website contains thousands of pages of searchable technical content, including links to products, technologies, solutions, technical tips, and tools. Registered Cisco.com users can log in from this page to access even more content.	http://www.cisco.com/techsupport

Feature Information for Implementing IPv6 Addressing and Basic Connectivity

[Table 10](#) lists the features in this module and provides links to specific configuration information. Only features that were introduced or modified in Cisco IOS Release 12.2(2)T or a later release appear in the table.

For information on a feature in this technology that is not documented here, see “Start Here: Cisco IOS Software Release Specifies for IPv6 Features.”

Not all commands may be available in your Cisco IOS software release. For release information about a specific command, see the command reference documentation.

Cisco IOS software images are specific to a Cisco IOS software release, a feature set, and a platform. Use Cisco Feature Navigator to find information about platform support and Cisco IOS software image support. Access Cisco Feature Navigator at <http://www.cisco.com/go/fn>. You must have an account on Cisco.com. If you do not have an account or have forgotten your username or password, click **Cancel** at the login dialog box and follow the instructions that appear.

**Note**

[Table 10](#) lists only the Cisco IOS software release that introduced support for a given feature in a given Cisco IOS software release train. Unless noted otherwise, subsequent releases of that Cisco IOS software release train also support that feature.

Table 10 Feature Information for Implementing IPv6 Addressing and Basic Connectivity

Feature Name	Releases	Feature Information
IPv6: ICMPv6	12.0(22)S, 12.0(21)ST, 12.2(14)S, 12.2(28)SB, 12.2(33)SRA, 12.2(2)T, 12.3, 12.3(2)T, 12.4, 12.4(2)T	<p>ICMP for IPv6 generates error messages, such as ICMP destination unreachable messages, and informational messages, such as ICMP echo request and reply messages. Additionally, ICMP packets in IPv6 are used in the IPv6 neighbor discovery process, path MTU discovery, and the MLD protocol for IPv6.</p> <p>The following sections provide information about this feature:</p> <ul style="list-style-type: none"> • ICMP for IPv6, page 34 • IPv6 Neighbor Discovery, page 34 • IPv6 Neighbor Solicitation Message, page 35 • IPv6 Router Advertisement Message, page 36 • IPv6 Stateless Autoconfiguration, page 40 • Configuring IPv6 ICMP Rate Limiting, page 55 • IPv6 ICMP Rate Limiting Configuration: Example, page 74
IPv6: ICMPv6 redirect	12.0(22)S, 12.0(21)ST, 12.2(14)S, 12.2(28)SB, 12.2(33)SRA, 12.2(4)T, 12.3, 12.3(2)T, 12.4, 12.4(2)T	<p>A value of 137 in the Type field of the ICMP packet header identifies an IPv6 neighbor redirect message. Routers send neighbor redirect messages to inform hosts of better first-hop nodes on the path to a destination.</p> <p>The following sections provide information about this feature:</p> <ul style="list-style-type: none"> • IPv6 Neighbor Redirect Message, page 38 • IPv6 Redirect Messages, page 66
IPv6: IPv6 default router preferences	12.2(33)SRA, 12.4(2)T	<p>The DRP extension provides a coarse preference metric (low, medium, or high) for default routers.</p> <p>The following sections provide information about this feature:</p> <ul style="list-style-type: none"> • Default Router Preferences for Traffic Engineering, page 38 • Configuring the DRP Extension for Traffic Engineering, page 56
IPv6: IPv6 MTU path discovery	12.0(22)S, 12.0(21)ST, 12.2(14)S, 12.2(28)SB, 12.2(33)SRA, 12.2(2)T, 12.3, 12.3(2)T, 12.4, 12.4(2)T	<p>Path MTU discovery in IPv6 allows a host to dynamically discover and adjust to differences in the MTU size of every link along a given data path.</p> <p>The following sections provide information about this feature:</p> <ul style="list-style-type: none"> • Path MTU Discovery for IPv6, page 33 • ICMP for IPv6, page 34

Table 10 Feature Information for Implementing IPv6 Addressing and Basic Connectivity

Feature Name	Releases	Feature Information
IPv6: IPv6 neighbor discovery	12.0(22)S, 12.0(21)ST, 12.2(14)S, 12.2(28)SB, 12.2(33)SRA, 12.2(2)T, 12.3, 12.3(2)T, 12.4, 12.4(2)T	<p>The IPv6 neighbor discovery process uses ICMP messages and solicited-node multicast addresses to determine the link-layer address of a neighbor on the same network (local link), verify the reachability of a neighbor, and track neighboring routers.</p> <p>The following sections provide information about this feature:</p> <ul style="list-style-type: none"> • Link-Local Address, page 24 • ICMP for IPv6, page 34 • IPv6 Neighbor Discovery, page 34 • HSRP for IPv6, page 40 • IPv6 Multicast Groups, page 46
IPv6: IPv6 neighbor discovery duplicate address detection	12.0(22)S, 12.0(21)ST, 12.2(14)S, 12.2(28)SB, 12.2(33)SRA, 12.2(4)T, 12.3, 12.3(2)T, 12.4, 12.4(2)T	<p>IPv6 neighbor discovery duplicate address detection is performed first on a new, link-local IPv6 address before the address is assigned to an interface (the new address remains in a tentative state while duplicate address detection is performed).</p> <p>The following sections provide information about this feature:</p> <ul style="list-style-type: none"> • IPv6 Neighbor Solicitation Message, page 35 • IPv6 Stateless Autoconfiguration, page 40
IPv6: IPv6 stateless autoconfiguration	12.0(22)S, 12.0(21)ST, 12.2(14)S, 12.2(28)SB, 12.2(33)SRA, 12.2(2)T, 12.3, 12.3(2)T, 12.4, 12.4(2)T	<p>The IPv6 stateless autoconfiguration feature can be used to manage link, subnet, and site addressing changes.</p> <p>The following sections provide information about this feature:</p> <ul style="list-style-type: none"> • Link-Local Address, page 24 • IPv6 Neighbor Solicitation Message, page 35 • IPv6 Router Advertisement Message, page 36 • IPv6 Stateless Autoconfiguration, page 40 • Simplified Network Renumbering for IPv6 Hosts, page 41
IPv6: IPv6 static cache entry for neighbor discovery	12.0(22)S, 12.2(14)S, 12.2(28)SB, 12.2(33)SRA, 12.2(8)T, 12.3, 12.3(2)T, 12.4, 12.4(2)T	<p>The IPv6 static cache entry for neighbor discovery feature allows static entries to be made in the IPv6 neighbor cache.</p> <p>The following section provides information about this feature:</p> <ul style="list-style-type: none"> • IPv6 Neighbor Discovery, page 34

Table 10 Feature Information for Implementing IPv6 Addressing and Basic Connectivity

Feature Name	Releases	Feature Information
IPv6: syslog over IPv6	12.4(4)T	<p>The Cisco IOS syslog process in IPv6 allows users to log syslog messages to external syslog servers and hosts with IPv6 addresses.</p> <p>The following sections provide information about this feature:</p> <ul style="list-style-type: none"> • Simplified IPv6 Packet Header, page 27 • Configuring Syslog over IPv6, page 54
IPv6 access services: Remote bridged encapsulation (RBE)	12.3(4)T, 12.4, 12.4(2)T	<p>RBE provides a mechanism for routing a protocol from a bridged interface to another routed or bridged interface.</p> <p>The following section provides information about this feature:</p> <ul style="list-style-type: none"> • Routed Bridge Encapsulation for IPv6, page 44
IPv6 address types: Anycast	12.2(25)S, 12.2(28)SB, 12.2(33)SRA, 12.3(4)T, 12.4, 12.4(2)T	<p>An anycast address is an address that is assigned to a set of interfaces that typically belong to different nodes.</p> <p>The following sections provide information about this feature:</p> <ul style="list-style-type: none"> • IPv6 Address Type: Anycast, page 24 • IPv6 Address Type: Multicast, page 25 • IPv6 Multicast Groups, page 46 • Configuring IPv6 Addressing and Enabling IPv6 Routing, page 45
IPv6 address types: Unicast	12.0(22)S, 12.0(21)ST, 12.2(14)S, 12.2(28)SB, 12.2(33)SRA, 12.2(2)T, 12.3, 12.3(2)T, 12.4, 12.4(2)T	<p>An IPv6 unicast address is an identifier for a single interface, on a single node.</p> <p>The following sections provide information about this feature:</p> <ul style="list-style-type: none"> • IPv6 Address Formats, page 20 • IPv6 Address Type: Unicast, page 21 • IPv6 Address Type: Anycast, page 24 • IPv6 Address Type: Multicast, page 25 • IPv6 Neighbor Solicitation Message, page 35 • IPv6 Router Advertisement Message, page 36 • Configuring IPv6 Addressing and Enabling IPv6 Routing, page 45

Table 10 Feature Information for Implementing IPv6 Addressing and Basic Connectivity

Feature Name	Releases	Feature Information
IPv6 data link: ATM PVC and ATM LANE	12.0(22)S, 12.0(21)ST, 12.2(14)S, 12.2(28)SB, 12.2(33)SRA, 12.2(2)T, 12.3, 12.3(2)T, 12.4, 12.4(2)T	In IPv6 networks, a data link is a network sharing a particular link-local prefix. ATM PVC and ATM LANE are data links supported for IPv6. The following sections provide information about this feature: <ul style="list-style-type: none"> • IPv6 Data Links, page 43 • Configuring Cisco Express Forwarding and distributed Cisco Express Forwarding Switching for IPv6, page 57 • Mapping IPv6 Addresses to IPv6 ATM and Frame Relay Interfaces, page 63
IPv6 data link: Cisco High-Level Data Link Control (HDLC)	12.0(22)S, 12.0(21)ST, 12.2(14)S, 12.2(28)SB, 12.2(33)SRA, 12.2(2)T, 12.3, 12.3(2)T, 12.4, 12.4(2)T	In IPv6 networks, a data link is a network sharing a particular link-local prefix. HDLC is a type of data link supported for IPv6. The following sections provide information about this feature: <ul style="list-style-type: none"> • IPv6 Data Links, page 43 • Configuring Cisco Express Forwarding and distributed Cisco Express Forwarding Switching for IPv6, page 57 • Mapping IPv6 Addresses to IPv6 ATM and Frame Relay Interfaces, page 63
IPv6 data link: Dynamic packet transport (DPT)	12.0(23)S	In IPv6 networks, a data link is a network sharing a particular link-local prefix. DPT is a type of data link supported for IPv6. The following section provides information about this feature: <ul style="list-style-type: none"> • IPv6 Data Links, page 43
IPv6 data link: Ethernet, Fast Ethernet, Gigabit Ethernet, and 10-Gigabit Ethernet	12.0(22)S, 12.0(21)ST, 12.2(14)S, 12.2(28)SB, 12.2(33)SRA, 12.2(2)T, 12.3, 12.3(2)T, 12.4, 12.4(2)T	In IPv6 networks, a data link is a network sharing a particular link-local prefix. Ethernet, Fast Ethernet, Gigabit Ethernet, and 10-Gigabit Ethernet are data links supported for IPv6. The following sections provide information about this feature: <ul style="list-style-type: none"> • IPv6 Data Links, page 43 • Configuring Cisco Express Forwarding and distributed Cisco Express Forwarding Switching for IPv6, page 57

Table 10 Feature Information for Implementing IPv6 Addressing and Basic Connectivity

Feature Name	Releases	Feature Information
IPv6 data link: FDDI	12.2(14)S, 12.2(28)SB, 12.2(33)SRA, 12.2(2)T, 12.3, 12.3(2)T, 12.4, 12.4(2)T	In IPv6 networks, a data link is a network sharing a particular link-local prefix. FDDI is a type of data link supported for IPv6. The following sections provide information about this feature: <ul style="list-style-type: none"> • IPv6 Data Links, page 43 • Configuring Cisco Express Forwarding and distributed Cisco Express Forwarding Switching for IPv6, page 57
IPv6 data link: Frame Relay PVC	12.0(22)S, 12.0(21)ST, 12.2(14)S, 12.2(28)SB, 12.2(33)SRA, 12.2(2)T, 12.3, 12.3(2)T, 12.4, 12.4(2)T	In IPv6 networks, a data link is a network sharing a particular link-local prefix. Frame relay PVC is a type of data link supported for IPv6. The following sections provide information about this feature: <ul style="list-style-type: none"> • IPv6 Data Links, page 43 • Configuring Cisco Express Forwarding and distributed Cisco Express Forwarding Switching for IPv6, page 57 • Mapping IPv6 Addresses to IPv6 ATM and Frame Relay Interfaces, page 63
IPv6 data link: PPP service over Packet over SONET, ISDN, and serial (synchronous and asynchronous) interfaces	12.0(22)S, 12.0(21)ST, 12.2(14)S, 12.2(28)SB, 12.2(33)SRA, 12.2(2)T, 12.3, 12.3(2)T, 12.4, 12.4(2)T	In IPv6 networks, a data link is a network sharing a particular link-local prefix. PPP service over Packet over SONET, ISDN, and serial interfaces is a type of data link supported for IPv6. The following sections provide information about this feature: <ul style="list-style-type: none"> • IPv6 Data Links, page 43 • Configuring Cisco Express Forwarding and distributed Cisco Express Forwarding Switching for IPv6, page 57 • Mapping IPv6 Addresses to IPv6 ATM and Frame Relay Interfaces, page 63
IPv6 data link: VLANs using Cisco Inter-Switch Link (ISL)	12.0(22)S, 12.2(14)S, 12.2(28)SB, 12.2(33)SRA, 12.2(2)T, 12.3, 12.3(2)T, 12.4, 12.4(2)T	In IPv6 networks, a data link is a network sharing a particular link-local prefix. VLANs using Cisco ISL is a type of data link supported for IPv6. The following section provides information about this feature: <ul style="list-style-type: none"> • IPv6 Data Links, page 43

Table 10 Feature Information for Implementing IPv6 Addressing and Basic Connectivity

Feature Name	Releases	Feature Information
IPv6 data link: VLANs using IEEE 802.1Q encapsulation	12.0(22)S, 12.2(28)SB, 12.2(33)SRA, 12.2(14)S, 12.2(2)T, 12.3, 12.3(2)T, 12.4, 12.4(2)T	In IPv6 networks, a data link is a network sharing a particular link-local prefix. VLANs using IEEE 802.1Q encapsulation is a type of data link supported for IPv6. The following section provides information about this feature: <ul style="list-style-type: none"> • IPv6 Data Links, page 43
IPv6 services: AAAA DNS lookups over an IPv4 transport	12.0(22)S, 12.0(21)ST, 12.2(14)S, 12.2(28)SB, 12.2(33)SRA, 12.2(2)T, 12.3, 12.3(2)T, 12.4, 12.4(2)T	IPv6 basic connectivity can be enhanced by configuring support for AAAA record types in the DNS name-to-address and address-to-name lookup processes. The following section provides information about this feature: <ul style="list-style-type: none"> • DNS for IPv6, page 33
IPv6 services: Cisco Discovery Protocol—IPv6 address family support for neighbor information	12.2(14)S, 12.2(28)SB, 12.2(33)SRA, 12.2(8)T, 12.3, 12.3(2)T, 12.4, 12.4(2)T	The Cisco Discovery Protocol IPv6 address support for neighbor information feature adds the ability to transfer IPv6 addressing information between two Cisco devices. The following section provides information about this feature: <ul style="list-style-type: none"> • Cisco Discovery Protocol IPv6 Address Support, page 34
IPv6 services: CISCO-IP-FORWARD-MIB support	12.0(22)S, 12.2(14)S, 12.2(28)SB, 12.2(33)SRA, 12.2(15)T, 12.3, 12.3(2)T, 12.4, 12.4(2)T	A MIB is a database of the objects that can be managed on a device. The managed objects, or variables, can be set or read to provide information on the network devices and interfaces.
IPv6 services: CISCO-IP-MIB support	12.0(22)S, 12.2(14)S, 12.2(28)SB, 12.2(33)SRA, 12.2(15)T, 12.3, 12.3(2)T, 12.4, 12.4(2)T	A MIB is a database of the objects that can be managed on a device. The managed objects, or variables, can be set or read to provide information on the network devices and interfaces.

Table 10 Feature Information for Implementing IPv6 Addressing and Basic Connectivity

Feature Name	Releases	Feature Information
IPv6 services: DNS lookups over an IPv6 transport	12.0(22)S, 12.0(21)ST, 12.2(14)S, 12.2(28)SB, 12.2(8)T, 12.3, 12.3(2)T, 12.4, 12.4(2)T	IPv6 supports DNS record types that are supported in the DNS name-to-address and address-to-name lookup processes. The following section provides information about this feature: <ul style="list-style-type: none"> • DNS for IPv6, page 33
IPv6 services: generic prefix	12.3(4)T, 12.4, 12.4(2)T	The upper 64 bits of an IPv6 address are composed from a global routing prefix plus a subnet ID. A general prefix (for example, /48) holds a short prefix, based on which a number of longer, more specific, prefixes (for example, /64) can be defined. The following sections provide information about this feature: <ul style="list-style-type: none"> • IPv6 General Prefixes, page 42 • Defining and Using IPv6 General Prefixes, page 50
IPv6 services: HSRP for IPv6	12.4(4)T	The HSRP is an FHRP designed to allow for transparent failover of the first-hop IP router. The following sections provide information about this feature: <ul style="list-style-type: none"> • HSRP for IPv6, page 40 • Enabling an HSRP Group for IPv6 Operation, page 48
IPv6 switching: Cisco Express Forwarding and distributed Cisco Express Forwarding support	12.0(21)ST, 12.0(22)S, 12.2(13)T, 12.2(14)S, 12.3, 12.3(2)T, 12.4, 12.4(2)T, 12.2(28)SB, 12.2(33)SRA	Cisco Express Forwarding for IPv6 is advanced, Layer 3 IP switching technology for the forwarding of IPv6 packets. Distributed Cisco Express Forwarding for IPv6 performs the same functions as CEFv6 but for distributed architecture platforms such as the Cisco 12000 series Internet routers and the Cisco 7500 series routers. The following sections provide information about this feature: <ul style="list-style-type: none"> • Cisco Express Forwarding and distributed Cisco Express Forwarding Switching for IPv6, page 31 • Configuring Cisco Express Forwarding and distributed Cisco Express Forwarding Switching for IPv6, page 57



Implementing ADSL and Deploying Dial Access for IPv6

This module describes the implementation of prefix pools and per-user Remote Access Dial-In User Service (RADIUS) attributes in IPv6. It also describes the deployment of IPv6 in Digital Subscriber Line (DSL) and dial-access environments. Asymmetric Digital Subscriber Line (ADSL) and dial deployment provide the extensions that make large-scale access possible for IPv6 environments, including IPv6 RADIUS attributes, stateless address configuration on Point-to-Point Protocol (PPP) links, per-user static routes, and access control lists (ACLs).

Finding Support Information for Platforms and Cisco IOS Software Images

Use Cisco Feature Navigator to find information about platform support and Cisco IOS software image support. Access Cisco Feature Navigator at <http://www.cisco.com/go/fn>. You must have an account on Cisco.com. If you do not have an account or have forgotten your username or password, click **Cancel** at the login dialog box and follow the instructions that appear.

Contents

- [Restrictions for Implementing ADSL and Deploying Dial Access for IPv6, page 90](#)
- [Information About Implementing ADSL and Deploying Dial Access for IPv6, page 90](#)
- [How to Configure ADSL and Deploy Dial Access in IPv6, page 94](#)
- [Configuration Examples for Implementing ADSL and Deploying Dial Access for IPv6, page 102](#)
- [Where to Go Next, page 103](#)
- [Additional References, page 103](#)

Prerequisites for Implementing ADSL and Dial Access for IPv6

[Table 11](#) identifies the earliest release for each early-deployment train in which each feature became available.

Table 11 Minimum Required Cisco IOS Release

Feature	Minimum Required Cisco IOS Release by Release Train
Enhanced IPv6 features for ADSL and dial deployment	12.2(13)T, 12.3, 12.3(2)T, 12.4, 12.4(2)T
AAA IPv6 attribute support	12.3(4)T, 12.4, 12.4(2)T
PPPoA	12.2(13)T, 12.3, 12.3(2)T, 12.4, 12.4(2)T
PPPoE	12.2(13)T, 12.3, 12.3(2)T, 12.4, 12.4(2)T
Prefix pools	12.2(13)T, 12.3, 12.3(2)T, 12.4, 12.4(2)T
AAA support for Cisco VSA IPv6 attributes	12.2(13)T, 12.3, 12.3(2)T, 12.4, 12.4(2)T
AAA support for RFC 3162 IPv6 RADIUS attributes	12.3(4)T, 12.4, 12.4(2)T
DHCPv6 prefix delegation	12.3(4)T, 12.2(18)SXE, 12.4, 12.4(2)T, 12.0(32)S, 12.2(28)SB, 12.2(33)SRA
DHCP for IPv6 prefix delegation via AAA	12.3(14)T, 12.2(18)SXE, 12.4, 12.4(2)T

Restrictions for Implementing ADSL and Deploying Dial Access for IPv6

ADSL and Dial Deployment is available for interfaces with PPP encapsulation enabled, including PPP over ATM (PPPoA), PPP over Ethernet (PPPoE), PPP over async, and PPP over ISDN.

Information About Implementing ADSL and Deploying Dial Access for IPv6

To implement ADSL and deploy dial access for IPv6, you need to understand the following concepts:

- [Address Assignment for IPv6, page 90](#)
- [AAA Attributes for IPv6, page 91](#)

Address Assignment for IPv6

A Cisco router configured with IPv6 will advertise its IPv6 prefixes on one or more interfaces, allowing IPv6 clients to automatically configure their addresses. In IPv6, address assignment is performed at the network layer, in contrast to IPv4 where a number of functions are handled in the PPP layer. The only function handled in IPv6 Control Protocol (IPv6CP) is the negotiation of a unique interface identifier. Everything else, including DNS server discovery, is done within the IPv6 protocol itself.

Contrary to IPv4 address assignment, an IPv6 user will be assigned a prefix, not a single address. Typically the Internet Service Provider (ISP) assigns a 64- or 48-bit prefix.

In the IPv6 world, Internet service providers (ISPs) assign long-lived prefixes to users, which has some impact on the routing system. In typical IPv4 environments, each network access server (NAS) has a pool of 24-bit addresses and users get addresses from this pool when dialing in. If a user dials another POP or is connected to another NAS at the same POP, a different IPv4 address is assigned.

Addresses for IPv6 are assigned by two different methods.

- [Stateless Address Autoconfiguration, page 91](#)
- [Prefix Delegation, page 91](#)

Stateless Address Autoconfiguration

Assigning addresses using the stateless address autoconfiguration method can only be used to assign 64-bit prefixes. Each user is assigned a 64-bit prefix, which is advertised to the user in a router advertisement (RA). All addresses are automatically configured based on the assigned prefix.

A typical scenario is to assign a separate 64-bit prefix per user; however, users can also be assigned a prefix from a shared pool of addresses. Using the shared limits addresses to only one address per user.

This solution works best for the cases where the customer provider edge router (CPE) is a single PC or is limited to only one subnet. If the user has multiple subnets, Layer 2 (L2) bridging, multilink subnets or proxy RA can be used. The prefix advertised in the RA can come from an authorization, authentication, and accounting (AAA) server, which also provides the prefix attribute, can be manually configured, or can be allocated from a prefix pool.

The Framed-Interface-Id AAA attribute influences the choice of interface identifier for peers and, in combination with the prefix, the complete IPv6 address can be determined.

Prefix Delegation

Prefix delegation uses Dynamic Host Configuration Protocol (DHCP). When the user requests a prefix from the prefix delegator, typically the NAS, the prefix is allocated as described in the [“Stateless Address Autoconfiguration” section on page 91](#).

An IPv6 prefix delegating router selects IPv6 prefixes to be assigned to a requesting router upon receiving a request from the client. The delegating router might select prefixes for a requesting router in the following ways:

- Static assignment based on subscription to an ISP
- Dynamic assignment from a pool of available prefixes
- Selection based on an external authority such as a RADIUS server using the Framed-IPv6-Prefix attribute (see the [“Framed-IPv6-Prefix” section on page 93](#)).

DHCP SIP Server Options

Two DHCP for IPv6 Session Initiation Protocol (SIP) server options describe a local outbound SIP proxy: one carries a list of domain names, the other a list of IPv6 addresses. These two options can be configured in a DHCPv6 configuration pool.

AAA Attributes for IPv6

Vendor-specific attributes (VSAs) have been developed to support AAA for IPv6. The Cisco VSAs are `inacl`, `outacl`, `route`, and `prefix`.

Prefix pools and pool names are configurable through AAA.

The following RADIUS attributes as described in RFC 3162 are supported for IPv6:

- Framed-Interface-Id
- Framed-IPv6-Prefix
- Login-IPv6-Host
- Framed-IPv6-Route
- Framed-IPv6-Pool

These attributes can be configured on a RADIUS server and downloaded to access servers where they can be applied to access connections.

AAA attributes are described in the following sections:

- [RADIUS Per-User Attributes for Virtual Access in IPv6 Environments, page 92](#)
- [IPv6 Prefix Pools, page 94](#)

Prerequisites for Using AAA Attributes for IPv6

The AAA attributes for IPv6 are compliant with RFC 3162 and require a RADIUS server capable of supporting RFC 3162.

RADIUS Per-User Attributes for Virtual Access in IPv6 Environments

The following IPv6 attributes for RADIUS attribute-value (AV) pairs are supported for virtual access:

- [Framed-Interface-Id, page 92](#)
- [Framed-IPv6-Prefix, page 93](#)
- [Login-IPv6-Host, page 93](#)
- [Framed-IPv6-Route, page 93](#)
- [Framed-IPv6-Pool, page 93](#)
- [IPv6 Route, page 93](#)
- [IPv6 ACL, page 93](#)
- [IPv6 Prefix#, page 94](#)
- [IPv6 Pool, page 94](#)

Apart from the new IPv6 prefix and IPv6 pool attributes, these are all existing Cisco VSAs extended to support the IPv6 protocol.

Framed-Interface-Id

The Framed-Interface-Id attribute indicates the IPv6 interface identifier to be configured. This per-user attribute is used during the IPv6CP negotiations and may be used in access-accept packets. If the Interface-Identifier IPv6CP option has been successfully negotiated, this attribute must be included in an Acc-0Request packet as a hint by the NAS to the server that it would prefer that value.

Framed-IPv6-Prefix

The Framed-IPv6-Prefix attribute performs the same function as the Cisco VSA: It is used for virtual access only and indicates an IPv6 prefix (and corresponding route) to be configured. This attribute is a per-user attribute and lets the user specify which prefixes to advertise in Neighbor Discovery Router Advertisement messages. The Framed-IPv6-Prefix attribute may be used in access-accept packets and can appear multiple times. The NAS will create a corresponding route for the prefix.

To use this attribute for DHCP for IPv6 prefix delegation, create a profile for the same user on the RADIUS server. The user name associated with the second profile has the suffix “-dhcpv6.”

The Framed-IPv6-Prefix attribute in the two profiles is treated differently. If a NAS needs both to send a prefix in router advertisements (RAs) and delegate a prefix to a remote user’s network, the prefix for RA is placed in the Framed-IPv6-Prefix attribute in the user’s regular profile, and the prefix used for prefix delegation is placed in the attribute in the user’s separate profile.

Login-IPv6-Host

The Login-IPv6-Host attribute is a per-user attribute that indicates the IPv6 system with which to connect the user when the Login-Service attribute is included.

Framed-IPv6-Route

The Framed-IPv6-Route attribute performs the same function as the Cisco VSA: It is a per-user attribute that provides routing information to be configured for the user on the NAS. This attribute is a string attribute and is specified using the **ipv6 route** command.

Framed-IPv6-Pool

The IPv6-Pool attribute is a per-user attribute that contains the name of an assigned pool that should be used to assign an IPv6 prefix for the user. This pool should either be defined locally on the router or defined on a RADIUS server from which pools can be downloaded.

IPv6 Route

The IPv6 route attribute allows you to specify a per-user static route. A static route is appropriate when the Cisco IOS software cannot dynamically build a route to the destination. See the description of the **ipv6 route** command for more information about building static routes.

The following example shows the IPv6 route attribute used to define a static route.

```
cisco-avpair = "ipv6:route#1=2001:0DB8:cc00:1::/48",  
cisco-avpair = "ipv6:route#2=2001::0DB8:cc00:2::/48",
```

IPv6 ACL

You can specify a complete IPv6 access list. The unique name of the access list is generated automatically. The access list is removed when its user logs out. The previous access list on the interface is reapplied.

The **inacl** and **outacl** attributes allow you to a specific existing access list configured on the router. The following example shows ACL number 1 specified as the access list:

```
cisco-avpair = "ipv6:inacl#1=permit 2001:0DB8:cc00:1::/48",  
cisco-avpair = "ipv6:outacl#1=deny 2001:0DB8::/10",
```

IPv6 Prefix#

The IPv6 prefix# attribute lets you indicate which prefixes to advertise in Neighbor Discovery Router Advertisement messages. When the prefix# attribute is used, a corresponding route (marked as a per-user static route) is installed in the routing information base (RIB) tables for the given prefix.

```
cisco-avpair = "ipv6:prefix#1=2001:0db8:/64",
cisco-avpair = "ipv6:prefix#2=2001:0db8:/64",
```

IPv6 Pool

For RADIUS authentication, the IPv6 pool attribute extends the IPv4 address pool attributed to support the IPv6 protocol. It specifies the name of a local pool on the NAS from which to get the prefix and is used whenever the service is configured as PPP and whenever the protocol is specified as IPv6. Note that the address pool works in conjunction with local pooling. It specifies the name of the local pool that has been preconfigured on the NAS.

IPv6 Prefix Pools

The function of prefix pools in IPv6 is similar to that of address pools in IPv4. The main difference is that IPv6 assigns prefixes rather than single addresses.

As for IPv4, a pool or a pool definition can be configured locally or it can be retrieved from an AAA server. Overlapping membership between pools is not permitted.

Once a pool is configured, it cannot be changed. If you change the configuration, the pool will be removed and re-created. All prefixes previously allocated will be freed.

Prefix pools can be defined so that each user is allocated a 64-bit prefix or so that a single prefix is shared among several users. In a shared prefix pool, each user may receive only one address from the pool.

How to Configure ADSL and Deploy Dial Access in IPv6

The configuration guidelines contained in this section show how to configure ADSL and dial access in IPv6 environments.

- [Configuring the NAS, page 94](#) (required)
- [Configuring the Remote CE Router, page 97](#) (required)
- [Configuring the DHCP for IPv6 Server to Obtain Prefixes from RADIUS Servers, page 100](#) (optional)
- [Configuring DHCP for IPv6 AAA and SIP Options, page 101](#) (optional)

Configuring the NAS

The first step in setting up dial access is to configure the NAS. All of the dialer groups, access lists, and routes are known to the NAS. This task shows how to configure the NAS to implement ADSL and deploy dial access for IPv6 environments.

SUMMARY STEPS

1. **enable**

2. **configure terminal**
3. **hostname** *name*
4. **aaa new-model**
5. **aaa authentication ppp** {**default** | *list-name*} *method1* [*method2...*]
6. **aaa authorization configuration default** {**radius** | **tacacs+**}
7. **show ipv6 route** [*ipv6-address* | *ipv6-prefix/prefix-length* | *protocol* | *interface-type* | *interface-number*]
8. **virtual-profile virtual-template** *number*
9. **interface serial** *controller-number:timeslot*
10. **encapsulation** *encapsulation-type*
11. **exit**
12. **dialer-group** *group-number*
13. **ppp authentication** {*protocol1* [*protocol2...*]} [**if-needed**] [*list-name* | **default**] [**callin**] [**one-time**] [**optional**]
14. **interface virtual-template** *number*
15. **ipv6 enable**
16. **dialer-list** *dialer-group* **protocol** *protocol-name* {**permit** | **deny** | **list** *access-list-number* | *access-group*}
17. **radius-server host** {*hostname* | *ip-address*} [**test username** *user-name*] [**auth-port** *port-number*] [**ignore-auth-port**] [**acct-port** *port-number*] [**ignore-acct-port**] [**timeout** *seconds*] [**retransmit** *retries*] [**key string**] [**alias** {*hostname* | *ip-address*}] [**idle-time** *seconds*]

DETAILED STEPS

	Command or Action	Purpose
Step 1	enable Example: Router> enable	Enables privileged EXEC mode. <ul style="list-style-type: none"> • Enter your password if prompted.
Step 2	configure terminal Example: Router# configure terminal	Enters global configuration mode.
Step 3	hostname <i>name</i> Example: Router(config)# hostname cust1-53a	Specifies the host name for the network server.
Step 4	aaa new-model Example: Router(config)# aaa new-model	Enables the AAA server.

	Command or Action	Purpose
Step 5	<pre>aaa authentication ppp {default list-name} method1 [method2...]</pre> <p>Example: Router(config)# aaa authentication ppp default if-needed group radius</p>	Specifies one or more AAA authentication methods for use on serial interfaces that are running PPP.
Step 6	<pre>aaa authorization configuration default {radius tacacs+}</pre> <p>Example: Router(config)# aaa authorization network default group radius</p>	Downloads configuration information from the AAA server.
Step 7	<pre>show ipv6 route [ipv6-address ipv6-prefix/prefix-length protocol interface-type interface-number]</pre> <p>Example: Router(config)# show ipv6 route</p>	Shows the routes installed by the previous commands.
Step 8	<pre>virtual-profile virtual-template number</pre> <p>Example: Router(config)# virtual-profile virtual-template 1</p>	Enables virtual profiles by virtual interface template.
Step 9	<pre>interface serial controller-number:timeslot</pre> <p>Example: Router(config)# interface Serial0:15</p>	Specifies a serial interface created on a channelized E1 or channelized T1 controller (for ISDN PRI, channel-associated signaling, or robbed-bit signaling).
Step 10	<pre>encapsulation encapsulation-type</pre> <p>Example: Router(config-if)# encapsulation ppp</p>	Sets the encapsulation method used by the interface.
Step 11	<pre>exit</pre> <p>Example: Router(config-if)# exit</p>	Returns to global configuration mode.
Step 12	<pre>dialer-group group-number</pre> <p>Example: Router(config)# dialer-group 1</p>	Control access by configuring an interface to belong to a specific dialing group.
Step 13	<pre>ppp authentication {protocol1 [protocol2...]} [if-needed] [list-name default] [callin] [one-time] [optional]</pre> <p>Example: Router(config)# ppp authentication chap</p>	Enables Challenge Handshake Authentication Protocol (CHAP) or Password Authentication Protocol (PAP) or both and specifies the order in which CHAP and PAP authentication are selected on the interface.

	Command or Action	Purpose
Step 14	<pre>interface virtual-template <i>number</i></pre> <p>Example: Router(config)# interface virtual-template1</p>	Creates a virtual template interface that can be configured and applied dynamically in creating virtual access interfaces.
Step 15	<pre>ipv6 enable</pre> <p>Example: Router(config)# ipv6 enable</p>	Enables IPv6 processing on an interface that has not been configured with an explicit IPv6 address.
Step 16	<pre>dialer-list <i>dialer-group</i> protocol <i>protocol-name</i> {permit deny list <i>access-list-number</i> <i>access-group</i>}</pre> <p>Example: Router(config)# dialer-list 1 protocol ipv6 permit</p>	Defines a dial-on-demand routing (DDR) dialer list for dialing by protocol or by a combination of a protocol and a previously defined access list.
Step 17	<pre>radius-server host {<i>hostname</i> <i>ip-address</i>} [test <i>username</i> <i>user-name</i>] [auth-port <i>port-number</i>] [ignore-auth-port] [acct-port <i>port-number</i>] [ignore-acct-port] [timeout <i>seconds</i>] [retransmit <i>retries</i>] [key <i>string</i>] [alias {<i>hostname</i> <i>ip-address</i>}] [idle-time <i>seconds</i>]</pre> <p>Example: Router(config)# radius-server host 172.17.250.8 auth-port 1812 acct-port 1813 key testing123</p>	Specifies a RADIUS server host.

Troubleshooting Tips

Verify that the access list is installed correctly before proceeding with the next task. Use the **show ipv6 access-list** and **show ipv6 interface** commands.

What to Do Next

Configure the remote customer edge (CE) router as described in the [“Configuring the Remote CE Router”](#) section on page 97

Configuring the Remote CE Router

The following task describes how to configure each remote CE router.

SUMMARY STEPS

1. **enable**
2. **configure terminal**
3. **hostname** *name*
4. **interface** *bri number.subinterface-number* [**multipoint** | **point-to-point**]

5. **encapsulation** *encapsulation-type*
6. **ipv6 address autoconfig** [default]
7. **isdn switch-type** *switch-type*
8. **ppp authentication** {*protocol1* [*protocol2...*]} [if-needed] [*list-name* | **default**] [**callin**] [**one-time**]
9. **ppp multilink** [**bap** | **required**]
10. **exit**
11. **dialer-list** *dialer-group* **protocol** *protocol-name* {**permit** | **deny** | **list** *access-list-number* | *access-group*}
12. **ipv6 route** *ipv6-prefix/prefix-length* {*ipv6-address* | *interface-type interface-number* [*ipv6-address*]} [*administrative-distance*] [*administrative-multicast-distance* | **unicast** | **multicast**] [**tag** *tag*]

DETAILED STEPS

	Command or Action	Purpose
Step 1	enable Example: Router> enable	Enables privileged EXEC mode. <ul style="list-style-type: none"> Enter your password if prompted.
Step 2	configure terminal Example: Router# configure terminal	Enters global configuration mode.
Step 3	hostname <i>name</i> Example: Router(config)# hostname cust1-36a	Specifies the host name for the network server.
Step 4	interface bri <i>number.subinterface-number</i> [multipoint point-to-point] Example: Router(config)# interface BRI1/0	Configures a BRI interface and enters interface configuration mode.
Step 5	encapsulation <i>encapsulation-type</i> Example: Router(config-if)# encapsulation ppp	Sets the encapsulation method used by the interface.
Step 6	ipv6 address autoconfig [default] Example: Router(config-if)# ipv6 address autoconfig	Indicates that the IPv6 address will be generated automatically.
Step 7	isdn switch-type <i>switch-type</i> Example: Router(config-if)# isdn switch-type basic-net3	Specifies the central office switch type on the ISDN interface.

	Command or Action	Purpose
Step 8	<pre>ppp authentication {protocol1 [protocol2...]} [if-needed] [list-name default] [callin] [one-time]</pre> <p>Example: Router(config-if)# ppp authentication chap optional</p>	Enables Challenge Handshake Authentication Protocol (CHAP) or Password Authentication Protocol (PAP) or both and specifies the order in which CHAP and PAP authentication are selected on the interface.
Step 9	<pre>ppp multilink [bap required]</pre> <p>Example: Router(config-if)# ppp multilink</p>	Enables Multilink PPP (MLP) on an interface and, optionally, enables Bandwidth Allocation Control Protocol (BACP) and Bandwidth Allocation Protocol (BAP) for dynamic bandwidth allocation.
Step 10	<pre>exit</pre> <p>Example: Router(config-if)# exit</p>	Exits interface configuration mode and returns to global configuration mode.
Step 11	<pre>dialer-list dialer-group protocol protocol-name {permit deny list access-list-number access-group}</pre> <p>Example: Router(config)# dialer-list 1 protocol ipv6 permit</p>	Defines a dial-on-demand routing (DDR) dialer list for dialing by protocol or by a combination of a protocol and a previously defined access list.
Step 12	<pre>ipv6 route ipv6-prefix/prefix-length {ipv6-address interface-type interface-number [ipv6-address]} [administrative-distance] [administrative-multicast-distance unicast multicast] [tag tag]</pre> <p>Example: Router(config)# ipv6 route 2001:0db8:1/128 BRI1/0</p>	Establishes static IPv6 routes. Use one command for each route.

What to Do Next

Once you have configured the NAS and CE router, configure RADIUS to establish the AV pairs for callback. Callback allows remote network users to dial in to the NAS without being charged. When callback is required, the NAS hangs up the current call and dials the caller back. When the NAS performs the callback, only information for the outgoing connection is applied. The rest of the attributes from the preauthentication access-accept message are discarded.

The following example shows a RADIUS profile configuration for a local campus:

```
campus1 Auth-Type = Local, Password = "mypassword"
      User-Service-Type = Framed-User,
      Framed-Protocol = PPP,
      cisco-avpair = "ipv6:inacl#1=permit dead::/64 any",
      cisco-avpair = "ipv6:route=dead::/64",
      cisco-avpair = "ipv6:route=cafe::/64",
      cisco-avpair = "ipv6:prefix=dead::/64 0 0 onlink autoconfig",
      cisco-avpair = "ipv6:prefix=cafe::/64 0 0 onlink autoconfig",
      cisco-avpair = "ip:route=10.0.0.0 255.0.0.0",
```

The RADIUS AV pairs for IPv6 are described in [RADIUS Per-User Attributes for Virtual Access in IPv6 Environments, page 92](#).

Refer to the *Cisco IOS Security Configuration Guide* for detailed information about configuring RADIUS.

Configuring the DHCP for IPv6 Server to Obtain Prefixes from RADIUS Servers

The following task describes how to configure the DHCP for IPv6 server to obtain prefixes from RADIUS servers.

Prerequisites

Before you perform this task, you must configure the AAA client and PPP on the router.

SUMMARY STEPS

1. **enable**
2. **configure terminal**
3. **interface** *type number*
4. **ipv6 nd prefix framed-ipv6-prefix**

DETAILED STEPS

	Command or Action	Purpose
Step 1	enable Example: Router> enable	Enables privileged EXEC mode. <ul style="list-style-type: none"> • Enter your password if prompted.
Step 2	configure terminal Example: Router# configure terminal	Enters global configuration mode.
Step 3	interface <i>type number</i> Example: Router(config)# interface ethernet 0/0	Specifies an interface type and number, and places the router in interface configuration mode.
Step 4	ipv6 nd prefix framed-ipv6-prefix Example: Router(config-if)# ipv6 nd prefix framed-ipv6-prefix	Adds the prefix in a received RADIUS framed IPv6 prefix attribute to the interface's neighbor discovery prefix queue.

Configuring DHCP for IPv6 AAA and SIP Options

This optional task allows users to enable the router to support AAA and SIP options.

SUMMARY STEPS

1. **enable**
2. **configure terminal**
3. **ipv6 dhcp pool *poolname***
4. **prefix-delegation aaa [method-list *method-list*] [lifetime]**
5. **sip address *ipv6-address***
6. **sip domain-name *domain-name***

DETAILED STEPS

	Command or Action	Purpose
Step 1	enable Example: Router> enable	Enables privileged EXEC mode. <ul style="list-style-type: none">• Enter your password if prompted.
Step 2	configure terminal Example: Router# configure terminal	Enters global configuration mode.
Step 3	ipv6 dhcp pool <i>poolname</i> Example: Router(config)# ipv6 dhcp pool pool1	Configures a DHCP for IPv6 configuration information pool and enters DHCP for IPv6 pool configuration mode.
Step 4	prefix-delegation aaa [method-list <i>method-list</i>] [lifetime] Example: Router(config-dhcp)# prefix-delegation aaa method-list list1	Specifies that prefixes are to be acquired from AAA servers.
Step 5	sip address <i>ipv6-address</i> Example: Router(config-dhcp)# sip address 2001:0DB8::2	Configures a SIP server IPv6 address to be returned in the SIP server's IPv6 address list option to clients.
Step 6	sip domain-name <i>domain-name</i> Example: Router(config-dhcp)# sip domain sip1.cisco.com	Configures a SIP server domain name to be returned in the SIP server's domain name list option to clients.

Configuration Examples for Implementing ADSL and Deploying Dial Access for IPv6

This section provides the following configuration example:

- [Implementing ADSL and Deploying Dial Access for IPv6 Example, page 102](#)

Implementing ADSL and Deploying Dial Access for IPv6 Example

This example shows a typical configuration for ADSL and dial access. The following three separate configurations are required:

- [NAS Configuration](#)
- [Remote CE Router Configuration](#)
- [RADIUS Configuration](#)

NAS Configuration

This configuration for the ISP NAS shows the configuration that supports access from the remote CE router.

```
hostname cust1-53a
aaa new-model
aaa authentication ppp default if-needed group radius
aaa authorization network default group radius
virtual-profile virtual-template 1
interface Serial0:15
 encapsulation ppp
 dialer-group 1
 ppp authentication chap
!
interface Virtual-Templat1
 ipv6 enable
!
dialer-list 1 protocol ipv6 permit
radius-server host 172.17.250.8 auth-port 1812 acct-port 1813 key testing123
```

Remote CE Router Configuration

This configuration for the remote customer edge router shows PPP encapsulation and IPv6 routes defined.

```
hostname cust-36a
interface BRI1/0
 encapsulation ppp
 ipv6 enable
 isdn switch-type basic-net3
 ppp authentication chap optional
 ppp multilink
!
dialer-list 1 protocol ipv6 permit
ipv6 route 2001:0DB8:1/128 BRI1/0
ipv6 route ::/0 2001:0db8:1
```

RADIUS Configuration

This RADIUS configuration shows the definition of AV pairs to establish the static routes.

```
campus1 Auth-Type = Local, Password = "mypassword"
```

```

User-Service-Type = Framed-User,
Framed-Protocol = PPP,
cisco-avpair = "ipv6:inacl#1=permit dead::/64 any",
cisco-avpair = "ipv6:route=library::/64",
cisco-avpair = "ipv6:route=cafe::/64",
cisco-avpair = "ipv6:prefix=library::/64 0 0 onlink autoconfig",
cisco-avpair = "ipv6:prefix=cafe::/64 0 0 onlink autoconfig",
cisco-avpair = "ip:route=11.0.0.0 255.0.0.0",

```

Where to Go Next

For information about implementing routing protocols for IPv6, refer to the *Implementing RIP for IPv6*, *Implementing IS-IS for IPv6*, or the *Implementing Multiprotocol BGP for IPv6* module. For information about implementing security for IPv6 environments, refer to the *Implementing Security for IPv6* module.

Additional References

For additional information related to Implementing ADSL and deploying dial access for IPv6, refer to the following sections.

Related Documents

Related Topic	Document Title
Certification authority and interoperability, RA proxy	The chapter “Configuring Certification Authority Interoperability” in the <i>Cisco IOS Security Configuration Guide</i> , Release 12.4. http://www.cisco.com/univercd/cc/td/doc/product/software/ios123/123cgcr/sec_vcg.htm
RADIUS server configuration	<i>Cisco IOS Security Configuration Guide</i> , Release 12.4 (see above) and <i>Cisco IOS Dial Technologies Configuration Guide</i> , Release 12.4. http://www.cisco.com/univercd/cc/td/doc/product/software/ios123/123cgcr/dial_vcg.htm
Per-user configuration (AAA, AV pairs table, IP address pooling, RADIUS server configuration), large-scale dial-out, virtual templates and virtual profiles	<i>Cisco IOS Dial Technologies Configuration Guide</i> , Release 12.4.
ADSL, PPP	<i>Cisco IOS Wide Area Networking Configuration Guide</i> , Release 12.4. http://www.cisco.com/univercd/cc/td/doc/product/software/ios123/123cgcr/wan_vcg.htm
VSAs	<i>Cisco Access Register Concepts and Reference Guide</i> http://www.cisco.com/univercd/cc/td/doc/product/rtrmgmt/ansar/3_0/concepts/vsa.htm

Standards

Standards	Title
No new or modified standards are supported by this feature, and support for existing standards has not been modified by this feature.	—

MIBs

MIBs	MIBs Link
No new or modified MIBs are supported by this feature, and support for existing MIBs has not been modified by this feature.	To locate and download MIBs for selected platforms, Cisco IOS releases, and feature sets, use Cisco MIB Locator found at the following URL: http://www.cisco.com/go/mibs

RFCs

RFCs	Title
RFC 3162	<i>RADIUS and IPv6</i>
RFC 3177	<i>IAB/IESG Recommendations on IPv6 Address</i>
RFC 3319	<i>Dynamic Host Configuration Protocol (DHCPv6) Options for Session Initiated Protocol (SIP) Servers</i>

Technical Assistance

Description	Link
The Cisco Technical Support website contains thousands of pages of searchable technical content, including links to products, technologies, solutions, technical tips, and tools. Registered Cisco.com users can log in from this page to access even more content.	http://www.cisco.com/techsupport



Implementing Multiprotocol BGP for IPv6

This module describes how to configure multiprotocol Border Gateway Protocol (BGP) for IPv6. BGP is an Exterior Gateway Protocol (EGP) used mainly to connect separate routing domains that contain independent routing policies (autonomous systems). Connecting to a service provider for access to the Internet is a common use for BGP. BGP can also be used within an autonomous system and this variation is referred to as internal BGP (iBGP). Multiprotocol BGP is an enhanced BGP that carries routing information for multiple network layer protocol address families, for example, IPv6 address family and for IP multicast routes. All BGP commands and routing policy capabilities can be used with multiprotocol BGP.

Finding Support Information for Platforms and Cisco IOS Software Images

Use Cisco Feature Navigator to find information about platform support and Cisco IOS software image support. Access Cisco Feature Navigator at <http://www.cisco.com/go/fn>. You must have an account on Cisco.com. If you do not have an account or have forgotten your username or password, click **Cancel** at the login dialog box and follow the instructions that appear.

Contents

- [Prerequisites for Implementing Multiprotocol BGP for IPv6, page 105](#)
- [Information About Implementing Multiprotocol BGP for IPv6, page 106](#)
- [How to Implement Multiprotocol BGP for IPv6, page 107](#)
- [Configuration Examples for Multiprotocol BGP for IPv6, page 133](#)
- [Where to Go Next, page 135](#)
- [Additional References, page 136](#)

Prerequisites for Implementing Multiprotocol BGP for IPv6

- This module assumes that you are familiar with IPv6 addressing and basic configuration. Refer to the *Implementing Basic Connectivity for IPv6* module for more information.
- This module assumes that you are familiar with IPv4. Refer to the publications referenced in the “[Related Documents](#)” section for IPv4 configuration and command reference information, as needed.

[Table 12](#) identifies the earliest release for each early-deployment train in which each feature became available.

Table 12 Minimum Required Cisco IOS Release

Feature	Minimum Required Cisco IOS Release by Release Train
Multiprotocol BGP extensions for IPv6	12.2(2)T, 12.0(21)ST, 12.0(22)S, 12.2(14)S, 12.3, 12.3(2)T, 12.4, 12.4(2)T, 12.2(28)SB, 12.2(33)SRA
Configuring an IPv6 BGP routing process and BGP router ID	12.2(2)T, 12.0(21)ST, 12.0(22)S, 12.2(14)S, 12.3, 12.3(2)T, 12.4, 12.4(2)T, 12.2(28)SB
Configuring an IPv6 multiprotocol BGP Peer	12.2(2)T, 12.0(21)ST, 12.0(22)S, 12.2(14)S, 12.3, 12.3(2)T, 12.4, 12.4(2)T, 12.2(28)SB
Multiprotocol BGP link-local address peering	12.2(4)T, 12.0(21)ST, 12.0(22)S, 12.2(14)S, 12.3, 12.3(2)T, 12.4, 12.4(2)T, 12.2(28)SB, 12.2(33)SRA
Configuring an IPv6 multiprotocol BGP peer group	12.2(2)T, 12.0(21)ST, 12.0(22)S, 12.2(14)S, 12.3, 12.3(2)T, 12.4, 12.4(2)T, 12.2(28)SB
Advertising routes into IPv6 multiprotocol BGP	12.2(2)T, 12.0(21)ST, 12.0(22)S, 12.2(14)S, 12.3, 12.3(2)T, 12.4, 12.4(2)T, 12.2(28)SB
Configuring route maps for IPv6 multiprotocol BGP prefixes	12.2(2)T, 12.0(21)ST, 12.0(22)S, 12.2(14)S, 12.3, 12.3(2)T, 12.4, 12.4(2)T, 12.2(28)SB
Redistributing prefixes into IPv6 multiprotocol BGP	12.2(2)T, 12.0(21)ST, 12.0(22)S, 12.2(14)S, 12.3, 12.3(2)T, 12.4, 12.4(2)T, 12.2(28)SB
IPv6 multicast address family support for multiprotocol BGP	12.0(26)S, 12.2(25)S, 12.2(28)SB
6PE multipath	12.2(25)S, 12.2(28)SB

Information About Implementing Multiprotocol BGP for IPv6

To configure multiprotocol BGP extensions for IPv6, you need to understand the following concept:

- [Multiprotocol BGP Extensions for IPv6, page 106](#)
- [Multiprotocol BGP for the IPv6 Multicast Address Family, page 107](#)

Multiprotocol BGP Extensions for IPv6

Multiprotocol BGP is the supported EGP for IPv6. Multiprotocol BGP extensions for IPv6 supports the same features and functionality as IPv4 BGP. IPv6 enhancements to multiprotocol BGP include support for an IPv6 address family and network layer reachability information (NLRI) and next hop (the next router in the path to the destination) attributes that use IPv6 addresses.

Multiprotocol BGP for the IPv6 Multicast Address Family

The multiprotocol BGP for the IPv6 multicast address family feature provides multicast BGP extensions for IPv6 and supports the same features and functionality as IPv4 BGP. IPv6 enhancements to multicast BGP include support for an IPv6 multicast address family and network layer reachability information (NLRI) and next hop (the next router in the path to the destination) attributes that use IPv6 addresses.

Multicast BGP is an enhanced BGP that allows the deployment of interdomain IPv6 multicast. Multiprotocol BGP carries routing information for multiple network layer protocol address families; for example, IPv6 address family and for IPv6 multicast routes. The IPv6 multicast address family contains routes used for RPF lookup by the IPv6 PIM protocol, and multicast BGP IPv6 provides for interdomain transport of the same. Users must use multiprotocol BGP for IPv6 multicast when using IPv6 multicast with BGP because the unicast BGP learned routes will not be used for IPv6 multicast.

Multicast BGP functionality is provided through a separate address family context. A subsequent address family identifier (SAFI) provides information about the type of the network layer reachability information that is carried in the attribute. Multiprotocol BGP unicast uses SAFI 1 messages, and multiprotocol BGP multicast uses SAFI 2 messages. SAFI 1 messages indicate that the routes are only usable for IP unicast, but not IP multicast. Because of this functionality, BGP routes in the IPv6 unicast RIB must be ignored in the IPv6 multicast RPF lookup.

A separate BGP routing table is maintained to configure incongruent policies and topologies (for example, IPv6 unicast and multicast) by using IPv6 multicast RPF lookup. Multicast RPF lookup is very similar to the IP unicast route lookup.

No MRIB is associated with the IPv6 multicast BGP table. However, IPv6 multicast BGP operates on the unicast IPv6 RIB when needed. Multicast BGP does not insert or update routes into the IPv6 unicast RIB.

6PE Multipath

Internal and external BGP multipath for IPv6 allows the IPv6 router to load balance between several paths (for example, same neighboring autonomous system [AS] or sub-AS, or the same metric) to reach its destination. The 6PE multipath feature uses multiprotocol internal BGP (MP-iBGP) to distribute IPv6 routes over the MPLS IPv4 core network and to attach an MPLS label to each route.

When MP-iBGP multipath is enabled on the 6PE router, all labeled paths are installed in the forwarding table with MPLS information (label stack) when MPLS information is available. This functionality enables 6PE to perform load balancing.

How to Implement Multiprotocol BGP for IPv6

When configuring multiprotocol BGP extensions for IPv6, you must create the BGP routing process, configure peering relationships, and customize BGP for your particular network.



Note

The following sections describe the configuration tasks for creating an IPv6 multiprotocol BGP routing process and associating peers, peer groups, and networks to the routing process. The following sections do not provide in-depth information on customizing multiprotocol BGP because the protocol functions the same in IPv6 as it does in IPv4. See the “[Related Documents](#)” section for further information on BGP and multiprotocol BGP configuration and command reference information.

The tasks in the following sections explain how to configure multiprotocol BGP extensions for IPv6. Each task in the list is identified as either required or optional:

- [Configuring an IPv6 BGP Routing Process and BGP Router ID, page 108](#) (required)
- [Configuring an IPv6 Multiprotocol BGP Peer, page 109](#) (required)
- [Configuring an IPv6 Multiprotocol BGP Peer Using a Link-Local Address, page 111](#) (optional)
- [Configuring an IPv6 Multiprotocol BGP Peer Group, page 114](#) (optional)
- [Advertising Routes into IPv6 Multiprotocol BGP, page 117](#) (required)
- [Configuring a Route Map for IPv6 Multiprotocol BGP Prefixes, page 118](#) (optional)
- [Redistributing Prefixes into IPv6 Multiprotocol BGP, page 120](#) (optional)
- [Advertising IPv4 Routes Between IPv6 BGP Peers, page 122](#) (optional)
- [Assigning a BGP Administrative Distance, page 124](#) (optional)
- [Generating Translate Updates for IPv6 Multicast BGP, page 125](#) (optional)
- [Resetting BGP Sessions, page 127](#) (optional)
- [Clearing External BGP Peers, page 127](#) (optional)
- [Clearing IPv6 BGP Route Dampening Information, page 128](#) (optional)
- [Clearing IPv6 BGP Flap Statistics, page 129](#) (optional)
- [Verifying IPv6 Multiprotocol BGP Configuration and Operation, page 129](#) (optional)

Configuring an IPv6 BGP Routing Process and BGP Router ID

This task explains how to configure an IPv6 BGP routing process and an optional BGP router ID for a BGP-speaking router.

Prerequisites

Before configuring the router to run BGP for IPv6, you must globally enable IPv6 routing using the **ipv6 unicast-routing** global configuration command. For details on basic IPv6 connectivity tasks, refer to the *Implementing Basic Connectivity for IPv6* module.

BGP Router ID for IPv6

BGP uses a router ID to identify BGP-speaking peers. The BGP router ID is 32-bit value that is often represented by an IPv4 address. By default, the Cisco IOS software sets the router ID to the IPv4 address of a loopback interface on the router. If no loopback interface is configured on the router, then the software chooses the highest IPv4 address configured to a physical interface on the router to represent the BGP router ID. When configuring BGP on a router that is enabled only for IPv6 (the router does not have an IPv4 address), you must manually configure the BGP router ID for the router. The BGP router ID, which is represented as a 32-bit value using an IPv4 address syntax, must be unique to the BGP peers of the router.

SUMMARY STEPS

1. **enable**
2. **configure terminal**

3. **router bgp** *as-number*
4. **no bgp default ipv4-unicast**
5. **bgp router-id** *ip-address*

DETAILED STEPS

	Command or Action	Purpose
Step 1	enable Example: Router> enable	Enables privileged EXEC mode. <ul style="list-style-type: none"> • Enter your password if prompted.
Step 2	configure terminal Example: Router# configure terminal	Enters global configuration mode.
Step 3	router bgp <i>as-number</i> Example: Router(config)# router bgp 65000	Configures a BGP routing process, and enters router configuration mode for the specified routing process.
Step 4	no bgp default ipv4-unicast Example: Router(config-router)# no bgp default ipv4-unicast	Disables the IPv4 unicast address family for the BGP routing process specified in the previous step. Note Routing information for the IPv4 unicast address family is advertised by default for each BGP routing session configured with the neighbor remote-as router configuration command unless you configure the no bgp default ipv4-unicast router configuration command before configuring the neighbor remote-as command.
Step 5	bgp router-id <i>ip-address</i> Example: Router(config-router)# bgp router-id 192.168.99.70	(Optional) Configures a fixed 32-bit router ID as the identifier of the local router running BGP. Note Configuring a router ID using the bgp router-id command resets all active BGP peering sessions.

Configuring an IPv6 Multiprotocol BGP Peer

This task explains how to configure IPv6 multiprotocol BGP between two IPv6 routers (peers).

Restrictions

By default, neighbors that are defined using the **neighbor remote-as** command in router configuration mode exchange only IPv4 unicast address prefixes. To exchange other address prefix types, such as IPv6 prefixes, neighbors must also be activated using the **neighbor activate** command in address family configuration mode for the other prefix types, as shown for IPv6 prefixes.

SUMMARY STEPS

1. **enable**
2. **configure terminal**
3. **router bgp** *as-number*
4. **neighbor** {*ip-address* | *ipv6-address* | *peer-group-name*} **remote-as** *as-number*
5. **address-family ipv6** [**unicast** | **multicast**]
6. **neighbor** {*ip-address* | *peer-group-name* | *ipv6-address*} **activate**

DETAILED STEPS

	Command or Action	Purpose
Step 1	enable Example: Router> enable	Enables privileged EXEC mode. <ul style="list-style-type: none"> • Enter your password if prompted.
Step 2	configure terminal Example: Router# configure terminal	Enters global configuration mode.
Step 3	router bgp <i>as-number</i> Example: Router(config)# router bgp 65000	Enters router configuration mode for the specified routing process.
Step 4	neighbor { <i>ip-address</i> <i>ipv6-address</i> <i>peer-group-name</i> } remote-as <i>as-number</i> Example: Router(config-router)# neighbor 2001:0DB8:0:CC00::1 remote-as 64600	Adds the IPv6 address of the neighbor in the specified autonomous system to the IPv6 multiprotocol BGP neighbor table of the local router. <ul style="list-style-type: none"> • The <i>ipv6-address</i> argument in the neighbor remote-as command must be in the form documented in RFC 2373 where the address is specified in hexadecimal using 16-bit values between colons.

	Command or Action	Purpose
Step 5	<p>address-family ipv6 [unicast multicast]</p> <p>Example: Router(config-router)# address-family ipv6</p>	<p>Specifies the IPv6 address family and enters address family configuration mode.</p> <ul style="list-style-type: none"> The unicast keyword specifies the IPv6 unicast address family. By default, the router is placed in configuration mode for the IPv6 unicast address family if the unicast keyword is not specified with the address-family ipv6 command. The multicast keyword specifies IPv6 multicast address prefixes.
Step 6	<p>neighbor {<i>ip-address</i> <i>peer-group-name</i> <i>ipv6-address</i>} activate</p> <p>Example: Router(config-router-af)# neighbor 2001:0DB8:0:CC00::1 activate</p>	<p>Enables the neighbor to exchange prefixes for the IPv6 address family with the local router.</p>

Configuring an IPv6 Multiprotocol BGP Peer Using a Link-Local Address

This task explains how to configure IPv6 multiprotocol BGP between two peers using link-local addresses.

Multiprotocol BGP Peering Using Link-Local Addresses

Configuring IPv6 multiprotocol BGP between two IPv6 routers (peers) using link-local addresses requires that the interface for the neighbor be identified by using the **update-source** router configuration command and that a route map be configured to set an IPv6 global next hop.

Restrictions

- By default, neighbors that are defined using the **neighbor remote-as** command in router configuration mode exchange only IPv4 unicast address prefixes. To exchange other address prefix types, such as IPv6 prefixes, neighbors must also be activated using the **neighbor activate** command in address family configuration mode for the other prefix types, as shown for IPv6 prefixes.
- By default, route maps that are applied in router configuration mode using the **neighbor route-map** command are applied to only IPv4 unicast address prefixes. Route maps for other address families must be applied in address family configuration mode using the **neighbor route-map** command, as shown for the IPv6 address family. The route maps are applied either as the inbound or outbound routing policy for neighbors under the specified address family. Configuring separate route maps under each address family type simplifies managing complicated or different policies for each address family.

SUMMARY STEPS

- enable**
- configure terminal**
- router bgp** *autonomous-system-number*

4. **neighbor** {*ip-address* | *ipv6-address* | *peer-group-name*} **remote-as** *as-number*
5. **neighbor** {*ip-address* | *ipv6-address* | *peer-group-name*} **update-source** *interface-type interface-number*
6. **address-family** **ipv6** [**unicast** | **multicast**]
7. **neighbor** {*ip-address* | *peer-group-name* | *ipv6-address*} **activate**
8. **neighbor** {*ip-address* | *peer-group-name* | *ipv6-address*} **route-map** *map-name* {**in** | **out**}
9. **exit**
10. Repeat Step 9.
11. **route-map** *map-tag* [**permit** | **deny**] [*sequence-number*]
12. **match** **ipv6** **address** {**prefix-list** *prefix-list-name* | *access-list-name*}
13. **set** **ipv6** **next-hop** *ipv6-address* [*link-local-address*] [**peer-address**]

DETAILED STEPS

	Command or Action	Purpose
Step 1	enable Example: Router> enable	Enables privileged EXEC mode. <ul style="list-style-type: none"> Enter your password if prompted.
Step 2	configure terminal Example: Router# configure terminal	Enters global configuration mode.
Step 3	router bgp <i>autonomous-system-number</i> Example: Router(config)# router bgp 65000	Enters router configuration mode for the specified routing process.
Step 4	neighbor { <i>ip-address</i> <i>ipv6-address</i> <i>peer-group-name</i> } remote-as <i>as-number</i> Example: Router(config-router)# neighbor FE80::XXXX:BFF:FE0E:A471 remote-as 64600	Adds the link-local IPv6 address of the neighbor in the specified remote autonomous system to the IPv6 multiprotocol BGP neighbor table of the local router. <ul style="list-style-type: none"> The <i>ipv6-address</i> argument in the neighbor remote-as command must be a link-local IPv6 address in the form documented in RFC 2373 where the address is specified in hexadecimal using 16-bit values between colons.
Step 5	neighbor { <i>ip-address</i> <i>ipv6-address</i> <i>peer-group-name</i> } update-source <i>interface-type interface-number</i> Example: Router(config-router)# neighbor FE80::XXXX:BFF:FE0E:A471 update-source fastethernet0	Specifies the link-local address over which the peering is to occur. <ul style="list-style-type: none"> If there are multiple connections to the neighbor and you do not specify the neighbor interface by using the <i>interface-type</i> and <i>interface-number</i> arguments in the neighbor update-source command, a TCP connection cannot be established with the neighbor using link-local addresses.

	Command or Action	Purpose
Step 6	<p>address-family ipv6 [unicast multicast]</p> <p>Example: Router(config-router)# address-family ipv6</p>	<p>Specifies the IPv6 address family, and enters address family configuration mode.</p> <ul style="list-style-type: none"> The unicast keyword specifies the IPv6 unicast address family. By default, the router is placed in configuration mode for the IPv6 unicast address family if the unicast keyword is not specified with the address-family ipv6 command. The multicast keyword specifies IPv6 multicast address prefixes.
Step 7	<p>neighbor {<i>ip-address</i> <i>peer-group-name</i> <i>ipv6-address</i>} activate</p> <p>Example: Router(config-router-af)# neighbor FE80::XXXX:BFF:FE0E:A471 activate</p>	<p>Enables the neighbor to exchange prefixes for the IPv6 address family with the local router using the specified link-local addresses.</p>
Step 8	<p>neighbor {<i>ip-address</i> <i>peer-group-name</i> <i>ipv6-address</i>} route-map <i>map-name</i> {in out}</p> <p>Example: Router(config-router-af)# neighbor FE80::XXXX:BFF:FE0E:A471 route-map nh6 out</p>	<p>Applies a route map to incoming or outgoing routes.</p>
Step 9	<p>exit</p> <p>Example: Router(config-router-af)# exit</p>	<p>Exits address family configuration mode, and returns the router to router configuration mode.</p>
Step 10	<p>Repeat Step 9.</p> <p>Example: Router(config-router)# exit</p>	<p>Exits router configuration mode, and returns the router to global configuration mode.</p>
Step 11	<p>route-map <i>map-tag</i> [permit deny] [<i>sequence-number</i>]</p> <p>Example: Router(config)# route-map nh6 permit 10</p>	<p>Defines a route map and enters route-map configuration mode.</p> <ul style="list-style-type: none"> Follow this step with a match command.

Command or Action	Purpose
<p>Step 12 <code>match ipv6 address {prefix-list prefix-list-name access-list-name}</code></p> <p>Example: Router(config-route-map)# match ipv6 address prefix-list cisco</p>	<p>Distributes any routes that have a destination IPv6 network number address permitted by a prefix list, or performs policy routing on packets.</p> <ul style="list-style-type: none"> Follow this step with a set command.
<p>Step 13 <code>set ipv6 next-hop ipv6-address [link-local-address] [peer-address]</code></p> <p>Example: Router(config-route-map)# set ipv6 next-hop 2001:0DB8::1</p>	<p>Overrides the next hop advertised to the peer for IPv6 packets that pass a match clause of a route map for policy routing.</p> <ul style="list-style-type: none"> The <i>ipv6-address</i> argument specifies the IPv6 global address of the next hop. It need not be an adjacent router. The <i>link-local-address</i> argument specifies the IPv6 link-local address of the next hop. It must be an adjacent router. <p>Note The route map sets the IPv6 next-hop addresses (global and link-local) in BGP updates. If the route map is not configured, the next-hop address in the BGP updates defaults to the unspecified IPv6 address (::), which is rejected by the peer.</p> <p>If you specify only the global IPv6 next-hop address (the <i>ipv6-address</i> argument) with the set ipv6 next-hop command after specifying the neighbor interface (the <i>interface-type</i> argument) with the neighbor update-source command in Step 5, the link-local address of the interface specified with the <i>interface-type</i> argument is included as the next-hop in the BGP updates. Therefore, only one route map that sets the global IPv6 next-hop address in BGP updates is required for multiple BGP peers that use link-local addresses.</p>

Troubleshooting Tips

Peering not established by this task may be due to a missing route map **set ipv6 next-hop** command. Use the **debug bgp ipv6 update** command to display debugging information on the updates to help determine the state of the peering.

Configuring an IPv6 Multiprotocol BGP Peer Group

This task explains how to configure an IPv6 peer group to perform multiprotocol BGP routing.

Restrictions

- By default, neighbors that are defined using the **neighbor remote-as** command in router configuration mode exchange only IPv4 unicast address prefixes. To exchange other address prefix types, such as IPv6 prefixes, neighbors must also be activated using the **neighbor activate** command in address family configuration mode for the other prefix types, as shown for IPv6 prefixes.
- By default, peer groups that are defined in router configuration mode using the **neighbor peer-group** command exchange only IPv4 unicast address prefixes. To exchange other address prefix types, such as IPv6 prefixes, you must activate peer groups using the **neighbor activate** command in address family configuration mode for the other prefix types, as shown for IPv6 prefixes.
- Members of a peer group automatically inherit the address prefix configuration of the peer group.
- IPv4 active neighbors cannot exist in the same peer group as active IPv6 neighbors. Create separate peer groups for IPv4 peers and IPv6 peers.

SUMMARY STEPS

1. **enable**
2. **configure terminal**
3. **router bgp** *as-number*
4. **neighbor** *peer-group-name* **peer-group**
5. **neighbor** {*ip-address* | *ipv6-address* | *peer-group-name*} **remote-as** *as-number*
6. **address-family ipv6** [**unicast** | **multicast**]
7. **neighbor** {*ip-address* | *peer-group-name* | *ipv6-address*} **activate**
8. **neighbor** {*ip-address* | *ipv6-address*} **send-label**
9. **neighbor** {*ip-address* | *ipv6-address*} **peer-group** *peer-group-name*
10. **exit**

DETAILED STEPS

	Command or Action	Purpose
Step 1	enable Example: Router> enable	Enables privileged EXEC mode. <ul style="list-style-type: none"> • Enter your password if prompted.
Step 2	configure terminal Example: Router# configure terminal	Enters global configuration mode.
Step 3	router bgp <i>as-number</i> Example: Router(config)# router bgp 65000	Enters router configuration mode for the specified BGP routing process.

	Command or Action	Purpose
Step 4	<p>neighbor <i>peer-group-name</i> peer-group</p> <p>Example: Router(config-router)# neighbor group1 peer-group</p>	Creates a multiprotocol BGP peer group.
Step 5	<p>neighbor {<i>ip-address</i> <i>ipv6-address</i> <i>peer-group-name</i>} remote-as <i>as-number</i></p> <p>Example: Router(config-router)# neighbor 2001:0DB8:0:CC00::1 remote-as 64600</p>	<p>Adds the IPv6 address of the neighbor in the specified autonomous system to the IPv6 multiprotocol BGP neighbor table of the local router.</p> <ul style="list-style-type: none"> The <i>ipv6-address</i> argument in the neighbor remote-as command must be in the form documented in RFC 2373 where the address is specified in hexadecimal using 16-bit values between colons.
Step 6	<p>address-family ipv6 [unicast multicast]</p> <p>Example: Router(config-router)# address-family ipv6 unicast</p>	<p>Specifies the IPv6 address family, and enters address family configuration mode.</p> <ul style="list-style-type: none"> The unicast keyword specifies the IPv6 unicast address family. By default, the router is placed in configuration mode for the IPv6 unicast address family if the unicast keyword is not specified with the address-family ipv6 command. The multicast keyword specifies IPv6 multicast address prefixes.
Step 7	<p>neighbor {<i>ip-address</i> <i>peer-group-name</i> <i>ipv6-address</i>} activate</p> <p>Example: Router(config-router-af)# neighbor 2001:0DB8:0:CC00::1 activate</p>	<p>Enables the neighbor to exchange prefixes for the specified family type with the neighbor and the local router.</p> <ul style="list-style-type: none"> To avoid extra configuration steps for each neighbor, use the neighbor activate command with the <i>peer-group-name</i> argument as an alternative in this step.
Step 8	<p>neighbor {<i>ip-address</i> <i>ipv6-address</i>} send-label</p> <p>Example: Router(config-router-af)# neighbor 192.168.99.70 send-label</p>	<p>Advertises the capability of the router to send MPLS labels with BGP routes.</p> <ul style="list-style-type: none"> In IPv6 address family configuration mode, this command enables binding and advertisement of aggregate labels when advertising IPv6 prefixes in BGP.
Step 9	<p>neighbor {<i>ip-address</i> <i>ipv6-address</i>} peer-group <i>peer-group-name</i></p> <p>Example: Router(config-router-af)# neighbor 2001:0DB8:0:CC00::1 peer-group group1</p>	Assigns the IPv6 address of a BGP neighbor to a peer group.
Step 10	<p>exit</p> <p>Example: Router(config-router-af)# exit</p>	<p>Exits address family configuration mode, and returns the router to router configuration mode.</p> <ul style="list-style-type: none"> Repeat this step to exit router configuration mode and return the router to global configuration mode.

What to Do Next

Refer to the section “Configure BGP Peer Groups” of the “Configuring BGP” chapter in *Cisco IOS IP Configuration Guide*, Release 12.4, for more information on assigning options to peer groups and making a BGP or multiprotocol BGP neighbor a member of a peer group.

Advertising Routes into IPv6 Multiprotocol BGP

This task explains how to advertise (inject) a prefix into IPv6 multiprotocol BGP.

Restrictions

By default, networks that are defined in router configuration mode using the **network** command are injected into the IPv4 unicast database. To inject a network into another database, such as the IPv6 BGP database, you must define the network using the **network** command in address family configuration mode for the other database, as shown for the IPv6 BGP database.

SUMMARY STEPS

1. **enable**
2. **configure terminal**
3. **router bgp** *as-number*
4. **address-family ipv6** [**unicast** | **multicast**]
5. **network** {*network-number* [**mask** *network-mask*] | *nsap-prefix*} [**route-map** *map-tag*]
6. **exit**

DETAILED STEPS

	Command or Action	Purpose
Step 1	enable Example: Router> enable	Enables privileged EXEC mode. <ul style="list-style-type: none"> • Enter your password if prompted.
Step 2	configure terminal Example: Router# configure terminal	Enters global configuration mode.
Step 3	router bgp <i>as-number</i> Example: Router(config)# router bgp 65000	Enters router configuration mode for the specified BGP routing process.

	Command or Action	Purpose
Step 4	<p>address-family ipv6 [unicast multicast]</p> <p>Example: Router(config-router)# address-family ipv6 unicast</p>	<p>Specifies the IPv6 address family, and enters address family configuration mode.</p> <ul style="list-style-type: none"> The unicast keyword specifies the IPv6 unicast address family. By default, the router is placed in configuration mode for the IPv6 unicast address family if the unicast keyword is not specified with the address-family ipv6 command. The multicast keyword specifies IPv6 multicast address prefixes.
Step 5	<p>network {<i>network-number</i> [mask <i>network-mask</i>] <i>nsap-prefix</i>} [route-map <i>map-tag</i>]</p> <p>Example: Router(config-router-af)# network 2001:0DB8::/24</p>	<p>Advertises (injects) the specified prefix into the IPv6 BGP database. (The routes must first be found in the IPv6 unicast routing table.)</p> <ul style="list-style-type: none"> Specifically, the prefix is injected into the database for the address family specified in the previous step. Routes are tagged from the specified prefix as “local origin.” The <i>ipv6-prefix</i> argument in the network command must be in the form documented in RFC 2373 where the address is specified in hexadecimal using 16-bit values between colons. The <i>prefix-length</i> argument is a decimal value that indicates how many of the high-order contiguous bits of the address comprise the prefix (the network portion of the address). A slash mark must precede the decimal value.
Step 6	<p>exit</p> <p>Example: Router(config-router-af)# exit</p>	<p>Exits address family configuration mode, and returns the router to router configuration mode.</p> <ul style="list-style-type: none"> Repeat this step to exit router configuration mode and return the router to global configuration mode.

Configuring a Route Map for IPv6 Multiprotocol BGP Prefixes

This task explains how to configure a route map for IPv6 multiprotocol BGP prefixes.

Restrictions

- By default, neighbors that are defined using the **neighbor remote-as** command in router configuration mode exchange only IPv4 unicast address prefixes. To exchange other address prefix types, such as IPv6 prefixes, neighbors must also be activated using the **neighbor activate** command in address family configuration mode for the other prefix types, as shown for IPv6 prefixes.
- By default, route maps that are applied in router configuration mode using the **neighbor route-map** command are applied to only IPv4 unicast address prefixes. Route maps for other address families must be applied in address family configuration mode using the **neighbor route-map** command, as shown for the IPv6 address family. The route maps are applied either as the inbound or outbound

routing policy for neighbors under the specified address family. Configuring separate route maps under each address family type simplifies managing complicated or different policies for each address family.

SUMMARY STEPS

1. **enable**
2. **configure terminal**
3. **router bgp** *as-number*
4. **neighbor** {*ip-address* | *ipv6-address* | *peer-group-name*} **remote-as** *as-number*
5. **address-family ipv6** [**unicast** | **multicast**]
6. **neighbor** {*ip-address* | *peer-group-name* | *ipv6-address*} **activate**
7. **neighbor** {*ip-address* | *peer-group-name* | *ipv6-address*} **route-map** *map-name* {**in** | **out**}
8. **exit**
9. Repeat Step 8.
10. **route-map** *map-tag* [**permit** | **deny**] [*sequence-number*]
11. **match ipv6 address** {**prefix-list** *prefix-list-name* | *access-list-name*}

DETAILED STEPS

	Command or Action	Purpose
Step 1	enable Example: Router> enable	Enables privileged EXEC mode. <ul style="list-style-type: none"> • Enter your password if prompted.
Step 2	configure terminal Example: Router# configure terminal	Enters global configuration mode.
Step 3	router bgp <i>as-number</i> Example: Router(config)# router bgp 65000	Enters router configuration mode for the specified routing process.
Step 4	neighbor { <i>ip-address</i> <i>ipv6-address</i> <i>peer-group-name</i> } remote-as <i>as-number</i> Example: Router(config-router)# neighbor 2001:0DB8:0:cc00::1 remote-as 64600	Adds the link-local IPv6 address of the neighbor in the specified remote autonomous system to the IPv6 multiprotocol BGP neighbor table of the local router. <ul style="list-style-type: none"> • The <i>ipv6-address</i> argument in the neighbor remote-as command must be a link-local IPv6 address in the form documented in RFC 2373 where the address is specified in hexadecimal using 16-bit values between colons.

	Command or Action	Purpose
Step 5	<p>address-family ipv6 [unicast multicast]</p> <p>Example: Router(config-router)# address-family ipv6</p>	<p>Specifies the IPv6 address family, and enters address family configuration mode.</p> <ul style="list-style-type: none"> The unicast keyword specifies the IPv6 unicast address family. By default, the router is placed in configuration mode for the IPv6 unicast address family if the unicast keyword is not specified with the address-family ipv6 command. The multicast keyword specifies IPv6 multicast address prefixes.
Step 6	<p>neighbor {<i>ip-address</i> <i>peer-group-name</i> <i>ipv6-address</i>} activate</p> <p>Example: Router(config-router-af)# neighbor 2001:0DB8:0:cc00::1 activate</p>	<p>Enables the neighbor to exchange prefixes for the IPv6 address family with the local router using the specified link-local addresses.</p>
Step 7	<p>neighbor {<i>ip-address</i> <i>peer-group-name</i> <i>ipv6-address</i>} route-map <i>map-name</i> {in out}</p> <p>Example: Router(config-router-af)# neighbor 2001:0DB8:0:cc00::1 route-map rtp in</p>	<p>Applies a route map to incoming or outgoing routes.</p> <ul style="list-style-type: none"> Changes to the route map will not take effect for existing peers until the peering is reset or a soft reset is performed. Using the clear bgp ipv6 command with the soft and in keywords will perform a soft reset.
Step 8	<p>exit</p> <p>Example: Router(config-router-af)# exit</p>	<p>Exits address family configuration mode, and returns the router to router configuration mode.</p>
Step 9	<p>Repeat Step 8.</p> <p>Example: Router(config-router)# exit</p>	<p>Exits router configuration mode, and returns the router to global configuration mode.</p>
Step 10	<p>route-map <i>map-tag</i> [permit deny] [<i>sequence-number</i>]</p> <p>Example: Router(config)# route-map rtp permit 10</p>	<p>Defines a route map and enters route-map configuration mode.</p> <ul style="list-style-type: none"> Follow this step with a match command.
Step 11	<p>match ipv6 address {prefix-list <i>prefix-list-name</i> <i>access-list-name</i>}</p> <p>Example: Router(config-route-map)# match ipv6 address prefix-list cisco</p>	<p>Distributes any routes that have a destination IPv6 network number address permitted by a prefix list, or performs policy routing on packets.</p>

Redistributing Prefixes into IPv6 Multiprotocol BGP

This task explains how to redistribute (inject) prefixes from another routing protocol into IPv6 multiprotocol BGP.

Redistribution for IPv6

Redistribution is the process of injecting prefixes from one routing protocol into another routing protocol. This task explains how to inject prefixes from a routing protocol into IPv6 multiprotocol BGP. Specifically, prefixes that are redistributed into IPv6 multiprotocol BGP using the **redistribute** router configuration command are injected into the IPv6 unicast database.

SUMMARY STEPS

1. **enable**
2. **configure terminal**
3. **router bgp** *as-number*
4. **address-family ipv6** [**unicast** | **multicast**]
5. **redistribute bgp** [*process-id*] [[**metric** *metric-value*] [**route-map** *map-name*]] [*source-protocol-options*]
6. **exit**

DETAILED STEPS

	Command or Action	Purpose
Step 1	enable Example: Router> enable	Enables privileged EXEC mode. <ul style="list-style-type: none"> • Enter your password if prompted.
Step 2	configure terminal Example: Router# configure terminal	Enters global configuration mode.
Step 3	router bgp <i>as-number</i> Example: Router(config)# router bgp 65000	Enters router configuration mode for the specified BGP routing process.
Step 4	address-family ipv6 [unicast multicast] Example: Router(config-router)# address-family ipv6	Specifies the IPv6 address family, and enters address family configuration mode. <ul style="list-style-type: none"> • The unicast keyword specifies the IPv6 unicast address family. By default, the router is placed in configuration mode for the IPv6 unicast address family if the unicast keyword is not specified with the address-family ipv6 command. • The multicast keyword specifies IPv6 multicast address prefixes.

	Command or Action	Purpose
Step 5	redistribute bgp [<i>process-id</i>] [[metric <i>metric-value</i>] [route-map <i>map-name</i>]] [<i>source-protocol-options</i>] Example: Router(config-router-af)# redistribute bgp 64500 metric 5 metric-type external	Redistributes IPv6 routes from one routing domain into another routing domain.
Step 6	exit Example: Router(config-router-af)# exit	Exits address family configuration mode, and returns the router to router configuration mode. <ul style="list-style-type: none"> Repeat this step to exit router configuration mode and return the router to global configuration mode.

Advertising IPv4 Routes Between IPv6 BGP Peers

This task explains how to advertise IPv4 routes between IPv6 peers. If an IPv6 network is connecting two separate IPv4 networks, it is possible to use IPv6 to advertise the IPv4 routes. Configure the peering using the IPv6 addresses within the IPv4 address family. Set the next hop with a static route or with an inbound route map because the advertised next hop will usually be unreachable. Advertising IPv6 routes between two IPv4 peers is also possible using the same model.

SUMMARY STEPS

- enable**
- configure terminal**
- router bgp** *as-number*
- neighbor** *peer-group-name* **peer-group**
- neighbor** {*ip-address* | *ipv6-address* | *peer-group-name*} **remote-as** *as-number*
- address-family ipv4** [**mdt** | **multicast** | **tunnel** | **unicast** [*vrf vrf-name*] | **vrf** *vrf-name*]
- neighbor** *ipv6-address* **peer-group** *peer-group-name*
- neighbor** {*ip-address* | *peer-group-name* | *ipv6-address*} **route-map** *map-name* {**in** | **out**}
- exit**
- Repeat Step 11.
- route-map** *map-tag* [**permit** | **deny**] [*sequence-number*]
- set ip next-hop** *ip-address* [... *ip-address*] [**peer-address**]

DETAILED STEPS

	Command or Action	Purpose
Step 1	enable Example: Router> enable	Enables privileged EXEC mode. <ul style="list-style-type: none"> Enter your password if prompted.
Step 2	configure terminal Example: Router# configure terminal	Enters global configuration mode.
Step 3	router bgp as-number Example: Router(config)# router bgp 65000	Enters router configuration mode for the specified routing process.
Step 4	neighbor peer-group-name peer-group Example: Router(config-router)# neighbor 6peers peer-group	Creates a multiprotocol BGP peer group.
Step 5	neighbor {ip-address ipv6-address peer-group-name} remote-as as-number Example: Router(config-router)# neighbor 6peers remote-as 65002	Adds the IPv6 address of the neighbor in the specified autonomous system to the IPv6 multiprotocol BGP neighbor table of the local router. <ul style="list-style-type: none"> The <i>ipv6-address</i> argument in the neighbor remote-as command must be in the form documented in RFC 2373 where the address is specified in hexadecimal using 16-bit values between colons.
Step 6	address-family ipv4 [mdt multicast tunnel unicast [vrf vrf-name] vrf vrf-name] Example: Router(config-router)# address-family ipv4	Enters address family configuration mode to configure a routing session using standard IPv4 address prefixes.
Step 7	neighbor ipv6-address peer-group peer-group-name Example: Router(config-router-af)# neighbor 2001:0DB8:yyyy::2 peer-group 6peers	Assigns the IPv6 address of a BGP neighbor to a peer group.
Step 8	neighbor {ip-address peer-group-name ipv6-address} route-map map-name {in out} Example: Router(config-router-af)# neighbor 6peers route-map rmap out	Applies a route map to incoming or outgoing routes. <ul style="list-style-type: none"> Changes to the route map will not take effect for existing peers until the peering is reset or a soft reset is performed. Using the clear bgp ipv6 command with the soft and in keywords will perform a soft reset.

	Command or Action	Purpose
Step 9	exit Example: Router(config-router-af)# exit	Exits address family configuration mode, and returns the router to router configuration mode.
Step 10	Repeat Step 11. Example: Router(config-router)# exit	Exits router configuration mode, and returns the router to global configuration mode.
Step 11	route-map <i>map-tag</i> [permit deny] [<i>sequence-number</i>] Example: Router(config)# route-map rmap permit 10	Defines a route map and enters route-map configuration mode.
Step 12	set ip next-hop ip-address [... <i>ip-address</i>] [<i>peer-address</i>] Example: Router(config-route-map)# set ip next-hop 10.21.8.10	Overrides the next hop advertised to the peer for IPv4 packets.

Assigning a BGP Administrative Distance

This task explains how to specify an administrative distance for multicast BGP routes to be used in RPF lookups for comparison with unicast routes.



Caution

Changing the administrative distance of BGP internal routes is considered dangerous and is not recommended. One problem that can arise is the accumulation of routing table inconsistencies, which can break routing.

SUMMARY STEPS

1. **enable**
2. **configure terminal**
3. **router bgp** *as-number*
4. **address family ipv6** [**unicast** | **multicast**]
5. **distance bgp** *external-distance internal-distance local-distance*

DETAILED STEPS

	Command or Action	Purpose
Step 1	enable Example: Router> enable	Enables privileged EXEC mode. <ul style="list-style-type: none"> Enter your password if prompted.
Step 2	configure terminal Example: Router# configure terminal	Enters global configuration mode.
Step 3	router bgp <i>as-number</i> Example: Router(config)# router bgp 65000	Enters router configuration mode for the specified routing process.
Step 4	address-family ipv6 [unicast multicast] Example: Router(config-router)# address-family ipv6	Specifies the IPv6 address family, and enters address family configuration mode. <ul style="list-style-type: none"> The unicast keyword specifies the IPv6 unicast address family. By default, the router is placed in configuration mode for the IPv6 unicast address family if the unicast keyword is not specified with the address-family ipv6 command. The multicast keyword specifies IPv6 multicast address prefixes.
Step 5	distance bgp <i>external-distance</i> <i>internal-distance local-distance</i> Example: Router(config-router-af)# distance bgp 10 50 100	Configures the administrative distance for BGP routes.

Generating Translate Updates for IPv6 Multicast BGP

This task explains how to generate IPv6 multicast BGP updates that correspond to unicast IPv6 updates received from a peer.

The MBGP translate-update feature generally is used in an MBGP-capable router that peers with a customer site that has only a BGP-capable router; the customer site has not or cannot upgrade its router to an MBGP-capable image. Because the customer site cannot originate MBGP advertisements, the router with which it peers will translate the BGP prefixes into MBGP prefixes, which are used for multicast-source Reverse Path Forwarding (RPF) lookup.

SUMMARY STEPS

- enable**
- configure terminal**
- router bgp** *as-number*

4. `address-family ipv6 [unicast | multicast]`
5. `neighbor ipv6-address translate-update ipv6 multicast [unicast]`

DETAILED STEPS

	Command or Action	Purpose
Step 1	<pre>enable</pre> <p>Example: Router> enable </p>	Enables privileged EXEC mode. <ul style="list-style-type: none"> • Enter your password if prompted.
Step 2	<pre>configure terminal</pre> <p>Example: Router# configure terminal </p>	Enters global configuration mode.
Step 3	<pre>router bgp as-number</pre> <p>Example: Router(config)# router bgp 65000 </p>	Enters router configuration mode for the specified routing process.
Step 4	<pre>address-family ipv6 [unicast multicast]</pre> <p>Example: Router(config-router)# address-family ipv6 </p>	Specifies the IPv6 address family, and enters address family configuration mode. <ul style="list-style-type: none"> • The unicast keyword specifies the IPv6 unicast address family. By default, the router is placed in configuration mode for the IPv6 unicast address family if the unicast keyword is not specified with the address-family ipv6 command. • The multicast keyword specifies IPv6 multicast address prefixes.
Step 5	<pre>neighbor ipv6-address translate-update ipv6 multicast [unicast]</pre> <p>Example: Router(config-router-af)# eighbor 7000::2 translate-update ipv6 multicast </p>	Generates multiprotocol IPv6 BGP updates that correspond to unicast IPv6 updates received from a peer.

Resetting BGP Sessions

This task explains how to reset IPv6 BGP sessions.

SUMMARY STEPS

1. **enable**
2. **clear bgp ipv6 {unicast | multicast} {* | autonomous-system-number | ip-address | ipv6-address | peer-group-name} [soft] [in | out]**

DETAILED STEPS

	Command or Action	Purpose
Step 1	<p>enable</p> <p>Example: Router> enable</p>	<p>Enables privileged EXEC mode.</p> <ul style="list-style-type: none"> • Enter your password if prompted.
Step 2	<p>clear bgp ipv6 {unicast multicast} {* autonomous-system-number ip-address ipv6-address peer-group-name} [soft] [in out]</p> <p>Example: Router# clear bgp ipv6 unicast peer-group marketing soft out</p>	<p>Resets IPv6 BGP sessions.</p>

Clearing External BGP Peers

This task explains how to clear external BGP peers and members of an IPv6 BGP peer group.

SUMMARY STEPS

1. **enable**
2. **clear bgp ipv6 {unicast | multicast} external [soft] [in | out]**
3. **clear bgp ipv6 {unicast | multicast} peer-group [name]**

DETAILED STEPS

	Command or Action	Purpose
Step 1	enable Example: Router> enable	Enables privileged EXEC mode. <ul style="list-style-type: none"> Enter your password if prompted.
Step 2	clear bgp ipv6 {unicast multicast} external [soft] [in out] Example: Router# clear bgp ipv6 unicast external soft in	Clears external IPv6 BGP peers.
Step 3	clear bgp ipv6 {unicast multicast} peer-group [name] Example: Router# clear bgp ipv6 unicast peer-group	Clears all members of an IPv6 BGP peer group.

Clearing IPv6 BGP Route Dampening Information

This task explains how to clear IPv6 BGP route dampening information and how to unsuppress suppressed routes.

SUMMARY STEPS

- enable
- clear bgp ipv6 {unicast | multicast} dampening [ipv6-prefix/prefix-length]

DETAILED STEPS

	Command or Action	Purpose
Step 1	enable Example: Router> enable	Enables privileged EXEC mode. <ul style="list-style-type: none"> Enter your password if prompted.
Step 2	clear bgp ipv6 {unicast multicast} dampening [ipv6-prefix/prefix-length] Example: Router# clear bgp ipv6 unicast dampening 2001:0DB8::/64	Clears IPv6 BGP route dampening information and unsuppress the suppressed routes.

Clearing IPv6 BGP Flap Statistics

This task explains how to clear IPv6 BGP flap statistics.

SUMMARY STEPS

1. **enable**
2. **clear bgp ipv6 {unicast | multicast} flap-statistics [ipv6-prefix/prefix-length | regexp regexp | filter-list list]**

DETAILED STEPS

	Command or Action	Purpose
Step 1	enable Example: Router> enable	Enables privileged EXEC mode. <ul style="list-style-type: none"> • Enter your password if prompted.
Step 2	clear bgp ipv6 {unicast multicast} flap-statistics [ipv6-prefix/prefix-length regexp regexp filter-list list] Example: Router# clear bgp ipv6 unicast flap-statistics filter-list 3	Clears IPv6 BGP flap statistics.

Verifying IPv6 Multiprotocol BGP Configuration and Operation

This task explains how to display information to verify the configuration and operation of IPv6 multiprotocol BGP.

SUMMARY STEPS

1. **show bgp ipv6 {unicast | multicast} [ipv6-prefix/prefix-length] [longer-prefixes] [labels]**
2. **show bgp ipv6 {unicast | multicast} summary**
3. **show bgp ipv6 {unicast | multicast} dampening dampened-paths**
4. **enable**
5. **debug bgp ipv6 {unicast | multicast} dampening [prefix-list prefix-list-name]**
6. **debug bgp ipv6 {unicast | multicast} updates [ipv6-address] [prefix-list prefix-list-name] [in | out]**

DETAILED STEPS

	Command or Action	Purpose
Step 1	<pre>show bgp ipv6 {unicast multicast} [ipv6-prefix/prefix-length] [longer-prefixes] [labels]</pre> <p>Example: Router> show bgp ipv6 unicast</p>	(Optional) Displays entries in the IPv6 BGP routing table.
Step 2	<pre>show bgp ipv6 {unicast multicast} summary</pre> <p>Example: Router> show bgp ipv6 unicast summary</p>	(Optional) Displays the status of all IPv6 BGP connections.
Step 3	<pre>show bgp ipv6 {unicast multicast} dampening dampened-paths</pre> <p>Example: Router> show bgp ipv6 unicast dampening dampened-paths</p>	(Optional) Displays IPv6 BGP dampened routes.
Step 4	<pre>enable</pre> <p>Example: Router> enable</p>	Enables higher privilege levels, such as privileged EXEC mode. <ul style="list-style-type: none"> Enter your password if prompted.
Step 5	<pre>debug bgp ipv6 {unicast multicast} dampening [prefix-list prefix-list-name]</pre> <p>Example: Router# debug bgp ipv6 unicast dampening</p>	(Optional) Displays debugging messages for IPv6 BGP dampening packets. <ul style="list-style-type: none"> If no prefix list is specified, debugging messages for all IPv6 BGP dampening packets are displayed.
Step 6	<pre>debug bgp ipv6 {unicast multicast} updates [ipv6-address] [prefix-list prefix-list-name] [in out]</pre> <p>Example: Router# debug bgp ipv6 unicast updates</p>	(Optional) Displays debugging messages for IPv6 BGP update packets. <ul style="list-style-type: none"> If an <i>ipv6-address</i> argument is specified, debugging messages for IPv6 BGP updates to the specified neighbor are displayed. Use the in keyword to display debugging messages for inbound updates only. Use the out keyword to display debugging messages for outbound updates only.

Output Examples

This section provides the following output examples:

- [Sample Output for the show bgp ipv6 Command](#)
- [Sample Output for the show bgp ipv6 summary Command](#)
- [Sample Output for the show bgp ipv6 dampened-paths Command](#)
- [Sample Output for the debug bgp ipv6 dampening Command](#)

- [Sample Output for the debug bgp ipv6 updates Command](#)

Sample Output for the show bgp ipv6 Command

In the following example, entries in the IPv6 BGP routing table are displayed using the **show bgp ipv6** command:

```
Router> show bgp ipv6 unicast
```

```
BGP table version is 12612, local router ID is 192.168.99.70
Status codes: s suppressed, d damped, h history, * valid, > best, i - internal
Origin codes: i - IGP, e - EGP, ? - incomplete

   Network          Next Hop          Metric LocPrf Weight Path
*>                2001:0DB8:E:C::2
*                  2001:0DB8:0:CC00::1
                                0 3748 4697 1752 i
                                0 1849 1273 1752 i
* 2001:618:3::/48  2001:0DB8:E:4::2    1
*>                2001:0DB8:0:CC00::1
                                0 1849 65002 i
*> 2001:620::/35   2001:0DB8:0:F004::1
                                0 3320 1275 559 i
*                  2001:0DB8:E:9::2
                                0 1251 1930 559 i
*                  2001:0DB8::A
                                0 3462 10566 1930 559 i
*                  2001:0DB8:20:1::11
                                0 293 1275 559 i
*                  2001:0DB8:E:4::2    1
*                  2001:0DB8:E:B::2
                                0 237 3748 1275 559 i
*                  2001:0DB8:E:C::2
                                0 3748 1275 559 i
```



Note

For a description of each output display field, refer to the **show bgp ipv6** command in the *IPv6 for Cisco IOS Command Reference* document.

Sample Output for the show bgp ipv6 summary Command

In the following example, the status of all IPv6 BGP connections is displayed using the **show bgp ipv6 summary** command with the **unicast** keyword:

```
Router# show bgp ipv6 unicast summary
```

```
BGP router identifier 172.30.4.4, local AS number 200
BGP table version is 1, main routing table version 1
```

Neighbor	V	AS	MsgRcvd	MsgSent	TblVer	InQ	OutQ	Up/Down	State/PfxRcd
2001:0DB8:101::2	4	200	6869	6882	0	0	0	06:25:24	Active

Sample Output for the show bgp ipv6 dampened-paths Command

In the following example, IPv6 BGP dampened routes are displayed using the **show bgp ipv6 dampened-paths** command with the **unicast** keyword:

```
Router# show bgp ipv6 unicast dampening dampened-paths
```

```
BGP table version is 12610, local router ID is 192.168.7.225
Status codes: s suppressed, d damped, h history, * valid, > best, i - internal
Origin codes: i - IGP, e - EGP, ? - incomplete
```

Network	From	Reuse	Path
---------	------	-------	------

```
*d 3FFE:1000::/24 3FFE:C00:E:B::2 00:00:10 237 2839 5609 i
*d 2001:228::/35 3FFE:C00:E:B::2 00:23:30 237 2839 5609 2713 i
```

Sample Output for the debug bgp ipv6 dampening Command

In the following example, debugging messages for IPv6 BGP dampening packets are displayed using the **debug bgp ipv6 dampening** command with the **unicast** keyword:



Note

By default, the system sends the output from **debug** commands and system error messages to the console. To redirect debugging output, use the **logging** command options within configuration mode. Possible destinations include the console, virtual terminals, internal buffer, and UNIX hosts running a syslog server. For complete information on **debug** commands and redirecting debugging output, refer to *Cisco IOS Debug Command Reference*, Release 12.4.

```
Router# debug bgp ipv6 unicast dampening

00:13:28:BGP(1):charge penalty for 2001:0DB8:0:1::/64 path 2 1 with halflife-time 15
reuse/suppress 750/2000
00:13:28:BGP(1):flapped 1 times since 00:00:00. New penalty is 1000
00:13:28:BGP(1):charge penalty for 2001:0DB8:0:1:1::/80 path 2 1 with halflife-time 15
reuse/suppress 750/2000
00:13:28:BGP(1):flapped 1 times since 00:00:00. New penalty is 1000
00:13:28:BGP(1):charge penalty for 2001:0DB8:0:5::/64 path 2 1 with halflife-time 15
reuse/suppress 750/2000
00:13:28:BGP(1):flapped 1 times since 00:00:00. New penalty is 1000
00:16:03:BGP(1):charge penalty for 2001:0DB8:0:1::/64 path 2 1 with halflife-time 15
reuse/suppress 750/2000
00:16:03:BGP(1):flapped 2 times since 00:02:35. New penalty is 1892
00:18:28:BGP(1):suppress 2001:0DB8:0:1:1::/80 path 2 1 for 00:27:30 (penalty 2671)
00:18:28:halflife-time 15, reuse/suppress 750/2000
00:18:28:BGP(1):suppress 2001:0DB8:0:1::/64 path 2 1 for 00:27:20 (penalty 2664)
00:18:28:halflife-time 15, reuse/suppress 750/2000
```

Sample Output for the debug bgp ipv6 updates Command

In the following example, debugging messages for IPv6 BGP update packets are displayed using the **debug bgp ipv6 updates** command with the **unicast** keyword:

```
Router# debug bgp ipv6 unicast updates

14:04:17:BGP(1):2001:0DB8:0:2::2 computing updates, afi 1, neighbor version 0, table
version 1, starting at ::
14:04:17:BGP(1):2001:0DB8:0:2::2 update run completed, afi 1, ran for 0ms, neighbor
version 0, start version 1, throttled to 1
14:04:19:BGP(1):sourced route for 2001:0DB8:0:2::1/64 path #0 changed (weight 32768)
14:04:19:BGP(1):2001:0DB8:0:2::1/64 route sourced locally
14:04:19:BGP(1):2001:0DB8:0:2:1::/80 route sourced locally
14:04:19:BGP(1):2001:0DB8:0:3::2/64 route sourced locally
14:04:19:BGP(1):2001:0DB8:0:4::2/64 route sourced locally
14:04:22:BGP(1):2001:0DB8:0:2::2 computing updates, afi 1, neighbor version 1, table
version 6, starting at ::
14:04:22:BGP(1):2001:0DB8:0:2::2 send UPDATE (format) 2001:0DB8:0:2::1/64, next
2001:0DB8:0:2::1, metric 0, path
14:04:22:BGP(1):2001:0DB8:0:2::2 send UPDATE (format) 2001:0DB8:0:2:1::/80, next
2001:0DB8:0:2::1, metric 0, path
```

```

14:04:22:BGP(1):2001:0DB8:0:2::2 send UPDATE (prepend, chgflags:0x208)
2001:0DB8:0:3::2/64, next 2001:0DB8:0:2::1, metric 0, path
14:04:22:BGP(1):2001:0DB8:0:2::2 send UPDATE (prepend, chgflags:0x208)
2001:0DB8:0:4::2/64, next 2001:0DB8:0:2::1, metric 0, path

```

Configuration Examples for Multiprotocol BGP for IPv6

This section provides the following configuration examples:

- [Configuring a BGP Process, BGP Router ID, and IPv6 Multiprotocol BGP Peer Example, page 133](#)
- [Configuring an IPv6 Multiprotocol BGP Peer Using a Link-Local Address Example, page 133](#)
- [Configuring an IPv6 Multiprotocol BGP Peer Group Example, page 134](#)
- [Advertising Routes into IPv6 Multiprotocol BGP Example, page 134](#)
- [Configuring a Route Map for IPv6 Multiprotocol BGP Prefixes Example, page 134](#)
- [Redistributing Prefixes into IPv6 Multiprotocol BGP Example, page 135](#)
- [Advertising IPv4 Routes Between IPv6 Peers Example, page 135](#)

Configuring a BGP Process, BGP Router ID, and IPv6 Multiprotocol BGP Peer Example

The following example enables IPv6 globally, configures a BGP process, and establishes a BGP router ID. Also, the IPv6 multiprotocol BGP peer 2001:0DB8:0:CC00::1 is configured and activated.

```

ipv6 unicast-routing
!
router bgp 65000
no bgp default ipv4-unicast
bgp router-id 192.168.99.70
neighbor 2001:0DB8:0:CC00::1 remote-as 64600

address-family ipv6 unicast
neighbor 2001:0DB8:0:CC00::1 activate

```

Configuring an IPv6 Multiprotocol BGP Peer Using a Link-Local Address Example

The following example configures the IPv6 multiprotocol BGP peer FE80::XXXX:BFF:FE0E:A471 over Fast Ethernet interface 0 and sets the route map named nh6 to include the IPv6 next-hop global address of Fast Ethernet interface 0 in BGP updates. The IPv6 next-hop link-local address can be set by the nh6 route map (not shown in the following example) or from the interface specified by the **neighbor update-source** router configuration command (as shown in the following example).

```

router bgp 65000
neighbor FE80::XXXX:BFF:FE0E:A471 remote-as 64600
neighbor FE80::XXXX:BFF:FE0E:A471 update-source fastethernet 0

address-family ipv6
neighbor FE80::XXXX:BFF:FE0E:A471 activate
neighbor FE80::XXXX:BFF:FE0E:A471 route-map nh6 out

route-map nh6 permit 10

```

```

match ipv6 address prefix-list cisco
set ipv6 next-hop 2001:0DB8:5y6::1

ipv6 prefix-list cisco permit 2001:0DB8:2Fy2::/48 le 128
ipv6 prefix-list cisco deny ::/0

```

**Note**

If you specify only the global IPv6 next-hop address (the *ipv6-address* argument) with the **set ipv6 next-hop** command after specifying the neighbor interface (the *interface-type* argument) with the **neighbor update-source** command, the link-local address of the interface specified with the *interface-type* argument is included as the next hop in the BGP updates. Therefore, only one route map that sets the global IPv6 next-hop address in BGP updates is required for multiple BGP peers that use link-local addresses.

Configuring an IPv6 Multiprotocol BGP Peer Group Example

The following example configures the IPv6 multiprotocol BGP peer group named group1:

```

router bgp 65000
no bgp default ipv4-unicast
neighbor group1 peer-group
neighbor 2001:0DB8:0:CC00::1 remote-as 64600

address-family ipv6 unicast
neighbor group1 activate
neighbor 2001:0DB8:0:CC00::1 peer-group group1

```

Advertising Routes into IPv6 Multiprotocol BGP Example

The following example injects the IPv6 network 2001:0DB8::/24 into the IPv6 unicast database of the local router. (BGP checks that a route for the network exists in the IPv6 unicast database of the local router before advertising the network.)

```

router bgp 65000
no bgp default ipv4-unicast

address-family ipv6 unicast
network 2001:0DB8::/24

```

Configuring a Route Map for IPv6 Multiprotocol BGP Prefixes Example

The following example configures the route map named rtp to permit IPv6 unicast routes from network 2001:0DB8::/24 if they match the prefix list named cisco:

```

router bgp 64900
no bgp default ipv4-unicast
neighbor 2001:0DB8:0:CC00::1 remote-as 64700

address-family ipv6 unicast
neighbor 2001:0DB8:0:CC00::1 activate
neighbor 2001:0DB8:0:CC00::1 route-map rtp in

ipv6 prefix-list cisco seq 10 permit 2001:0DB8::/24

route-map rtp permit 10
match ipv6 address prefix-list cisco

```

Redistributing Prefixes into IPv6 Multiprotocol BGP Example

The following example redistributes RIP routes into the IPv6 unicast database of the local router:

```
router bgp 64900
no bgp default ipv4-unicast
address-family ipv6 unicast
 redistribute rip
```

Advertising IPv4 Routes Between IPv6 Peers Example

The following example advertises IPv4 routes between IPv6 peers when the IPv6 network is connecting two separate IPv4 networks. Peering is configured using IPv6 addresses in the IPv4 address family configuration mode. The inbound route map named rmap sets the next hop because the advertised next hop is likely to be unreachable.

```
router bgp 65000
!
 neighbor 6peers peer-group
 neighbor 2001:0DB8:yyyy::2 remote-as 65002
 address-family ipv4
 neighbor 6peers activate
 neighbor 6peers soft-reconfiguration inbound
 neighbor 2001:0DB8:yyyy::2 peer-group 6peers
 neighbor 2001:0DB8:yyyy::2 route-map rmap in
!
 route-map rmap permit 10
 set ip next-hop 10.21.8.10
```

Where to Go Next

If you want to implement more IPv6 routing protocols, refer to the *Implementing RIP for IPv6* or the *Implementing IS-IS for IPv6* module.

Additional References

For additional information related to configuring multiprotocol BGP for IPv6, see the following sections.

Related Documents

Related Topic	Document Title
BGP configuration tasks	“Configuring BGP” chapter in the <i>Cisco IOS IP Configuration Guide</i> , Release 12.4
Multiprotocol BGP configuration tasks	“Configuring Multiprotocol BGP Extensions for IP Multicast” chapter in the <i>Cisco IOS IP Configuration Guide</i> , Release 12.4
BGP and multiprotocol BGP commands: complete command syntax, command mode, defaults, usage guidelines, and examples	<i>Cisco IOS IP Command Reference, Volume 2 of 3: Routing Protocols</i> , Release 12.4
IPv6 supported feature list	<i>Start Here: Cisco IOS Software Release Specifics for IPv6 Features</i>
IPv6 commands: complete command syntax, command mode, defaults, usage guidelines, and examples	<i>IPv6 for Cisco IOS Command Reference</i>
IPv4 configuration and command reference information	<i>Cisco IOS Release 12.4 Configuration Guides and Command References</i>

Standards

Standards	Title
No new or modified standards are supported by this feature, and support for existing standards has not been modified by this feature.	—

MIBs

MIBs	MIBs Link
No new or modified MIBs are supported by this feature, and support for existing MIBs has not been modified by this feature.	To locate and download MIBs for selected platforms, Cisco IOS releases, and feature sets, use Cisco MIB Locator found at the following URL: http://www.cisco.com/go/mibs

RFCs

RFCs ¹	Title
RFC 2545	<i>Use of BGP-4 Multiprotocol Extensions for IPv6 Inter-Domain Routing</i>
RFC 2858	<i>Multiprotocol Extensions for BGP-4</i>

1. Not all supported RFCs are listed.

Technical Assistance

Description	Link
The Cisco Technical Support website contains thousands of pages of searchable technical content, including links to products, technologies, solutions, technical tips, and tools. Registered Cisco.com users can log in from this page to access even more content.	http://www.cisco.com/techsupport



Implementing DHCP for IPv6

First Published: June 26, 2006

Last Updated: June 26, 2006

The “Implementing DHCP for IPv6” module describes how to configure Dynamic Host Configuration Protocol (DHCP) for IPv6 prefix delegation on your networking devices. General prefixes can be defined in several ways: manually, based on a 6to4 interface, and dynamically, from a prefix received by a DHCP for IPv6 prefix delegation client.

Finding Feature Information in This Module

Your Cisco IOS software release may not support all of the features documented in this module. To reach links to specific feature documentation in this module and to see a list of the releases in which each feature is supported, use the [“Feature Information for Implementing DHCP for IPv6”](#) section on page 161 or the *Start Here: Cisco IOS Software Release Specifics for IPv6 Features* in the *Cisco IOS IPv6 Configuration Library*.

Finding Support Information for Platforms and Cisco IOS and Catalyst OS Software Images

Use Cisco Feature Navigator to find information about platform support and Cisco IOS and Catalyst OS software image support. To access Cisco Feature Navigator, go to <http://www.cisco.com/go/cfn>. An account on Cisco.com is not required.

Contents

- [Prerequisites for Implementing DHCP for IPv6](#), page 139
- [Restrictions for Implementing DHCP for IPv6](#), page 140
- [Information About Implementing DHCP for IPv6](#), page 140
- [How to Implement DHCP for IPv6](#), page 144
- [Configuration Examples for Implementing DHCP for IPv6](#), page 157
- [Additional References](#), page 159
- [Feature Information for Implementing DHCP for IPv6](#), page 161

Prerequisites for Implementing DHCP for IPv6

This document assumes that you are familiar with IPv4. See the publications referenced in the [“Additional References”](#) section for IPv4 configuration and command reference information.

Restrictions for Implementing DHCP for IPv6

Cisco IOS Release 12.0S provides IPv6 support on Cisco 12000 series Internet routers and Cisco 10720 Internet routers only.

Information About Implementing DHCP for IPv6

To configure DHCP for IPv6 for Cisco IOS software, you must understand the following concept:

- [DHCP for IPv6 Prefix Delegation, page 140](#)

DHCP for IPv6 Prefix Delegation

The DHCP for IPv6 prefix delegation feature can be used to manage link, subnet, and site addressing changes. DHCP for IPv6 can be used in environments to deliver stateful and stateless information:

- **Stateful**—Address assignment is centrally managed and clients must obtain configuration information not available through protocols such as address autoconfiguration and neighbor discovery.
- **Stateless**—Stateless configuration parameters do not require a server to maintain any dynamic state for individual clients, such as Domain Name System (DNS) server addresses and domain search list options.

The DHCP for IPv6 implementation in Cisco IOS Release 12.3(4)T and Cisco IOS Release 12.0(32)S support only stateless address assignment.

Extensions to DHCP for IPv6 also enable prefix delegation, through which an Internet service provider (ISP) can automate the process of assigning prefixes to a customer for use within the customer's network. Prefix delegation occurs between a provider edge (PE) device and customer premises equipment (CPE), using the DHCP for IPv6 prefix delegation option. Once the ISP has delegated prefixes to a customer, the customer may further subnet and assign prefixes to the links in the customer's network.

Configuring Nodes Without Prefix Delegation

Stateless DHCP for IPv6 allows DHCP for IPv6 to be used for configuring a node with parameters that do not require a server to maintain any dynamic state for the node. The use of stateless DHCP is controlled by router advertisement (RA) messages multicasted by routers. The Cisco IOS DHCP for IPv6 client will invoke stateless DHCP for IPv6 when it receives an appropriate RA. The Cisco IOS DHCP for IPv6 server will respond to a stateless DHCP for IPv6 request with the appropriate configuration parameters, such as the DNS servers and domain search list options.

Client and Server Identification

Each DHCP for IPv6 client and server is identified by a DHCP unique identifier (DUID). The DUID is carried in the client identifier and server identifier options. The DUID is unique across all DHCP clients and servers, and it is stable for any specific client or server. DHCP for IPv6 uses DUIDs based on link-layer addresses for both the client and server identifier. The device uses the MAC address from the lowest-numbered interface to form the DUID. The network interface is assumed to be permanently attached to the device.

Rapid Commit

The DHCP for IPv6 client can obtain configuration parameters from a server either through a rapid two-message exchange (solicit, reply) or through a normal four-message exchange (solicit, advertise, request, reply). By default, the four-message exchange is used. When the rapid-commit option is enabled by both client and server, the two-message exchange is used.

DHCP for IPv6 Client, Server, and Relay Functions

The DHCP for IPv6 client, server, and relay functions are mutually exclusive on an interface. When one of these functions is already enabled and a user tries to configure a different function on the same interface, one of the following messages is displayed: “Interface is in DHCP client mode,” “Interface is in DHCP server mode,” or “Interface is in DHCP relay mode.”

Client Function

The DHCP for IPv6 client function can be enabled on individual IPv6-enabled interfaces.

The DHCP for IPv6 client can request and accept those configuration parameters that do not require a server to maintain any dynamic state for individual clients, such as DNS server addresses and domain search list options. The DHCP for IPv6 client will configure the local Cisco IOS stack with the received information.

The DHCP for IPv6 client can also request the delegation of prefixes. The prefixes acquired from a delegating router will be stored in a local IPv6 general prefix pool. The prefixes in the general prefix pool can then be referred to from other applications; for example, the general prefix pools can be used to number router downstream interfaces.

Server Selection

A DHCP for IPv6 client builds a list of potential servers by sending a solicit message and collecting advertise message replies from servers. These messages are ranked based on preference value, and servers may add a preference option to their advertise messages explicitly stating their preference value. If the client needs to acquire prefixes from servers, only servers that have advertised prefixes are considered.

IAPD and IAID

An Identity Association for Prefix Delegation (IAPD) is a collection of prefixes assigned to a requesting router. A requesting router may have more than one IAPD; for example, one for each of its interfaces.

Each IAPD is identified by an identity association identification (IAID). The IAID is chosen by the requesting router and is unique among the IAPD IAIDs on the requesting router. IAIDs are made consistent across reboots by using information from the associated network interface, which is assumed to be permanently attached to the device.

Server Function

The DHCP for IPv6 server function can be enabled on individual IPv6-enabled interfaces.

The DHCP for IPv6 server can provide those configuration parameters that do not require the server to maintain any dynamic state for individual clients, such as DNS server addresses and domain search list options. The DHCP for IPv6 server may be configured to perform prefix delegation.

All the configuration parameters for clients are independently configured into DHCP for IPv6 configuration pools, which are stored in NVRAM. A configuration pool can be associated with a particular DHCP for IPv6 server on an interface when it is started. Prefixes to be delegated to clients may be specified either as a list of preassigned prefixes for a particular client or as IPv6 local prefix pools that are also stored in NVRAM. The list of manually configured prefixes or IPv6 local prefix pools can be referenced and used by DHCP for IPv6 configuration pools.

The DHCP for IPv6 server maintains an automatic binding table in memory to track the assignment of some configuration parameters, such as prefixes between the server and its clients. The automatic bindings can be stored permanently in the database agent, which can be, for example, a remote TFTP server or local NVRAM file system.

Configuration Information Pool

A DHCP for IPv6 configuration information pool is a named entity that includes information about available configuration parameters and policies that control assignment of the parameters to clients from the pool. A pool is configured independently of the DHCP for IPv6 service and is associated with the DHCP for IPv6 service through the command-line interface (CLI).

Each configuration pool can contain the following configuration parameters and operational information:

- Prefix delegation information, which could include:
 - A prefix pool name and associated preferred and valid lifetimes
 - A list of available prefixes for a particular client and associated preferred and valid lifetimes
- A list of IPv6 addresses of DNS servers
- A domain search list, which is a string containing domain names for DNS resolution

Prefix Assignment

A prefix-delegating router (DHCP for IPv6 server) selects prefixes to be assigned to a requesting router (DHCP for IPv6 client) upon receiving a request from the client. The server can select prefixes for a requesting client using static assignment and dynamic assignment mechanisms. Administrators can manually configure a list of prefixes and associated preferred and valid lifetimes for an IAPD of a specific client that is identified by its DUID.

When the delegating router receives a request from a client, it checks if there is a static binding configured for the IAPD in the client's message. If a static binding is present, the prefixes in the binding are returned to the client. If no such a binding is found, the server attempts to assign prefixes for the client from other sources.

The Cisco IOS DHCP for IPv6 server can assign prefixes dynamically from an IPv6 local prefix pool. When the server receives a prefix request from a client, it attempts to obtain unassigned prefixes from the pool. After the client releases the previously assigned prefixes, the server returns them to the pool for reassignment.

An IPv6 prefix delegating router can also select prefixes for a requesting router based on an external authority such as a RADIUS server using the Framed-IPv6-Prefix attribute. For more information on this feature, see the *Implementing ADSL and Deploying Dial Access for IPv6* module.

Automatic Binding

Each DHCP for IPv6 configuration pool has an associated binding table. The binding table contains the records about all the prefixes in the configuration pool that have been explicitly delegated to clients. Each entry in the binding table contains the following information:

- Client DUID
- Client IPv6 address
- A list of IAPDs associated with the client
- A list of prefixes delegated to each IAPD
- Preferred and valid lifetimes for each prefix
- The configuration pool to which this binding table belongs
- The network interface on which the server that is using the pool is running

A binding table entry is automatically created whenever a prefix is delegated to a client from the configuration pool, and it is updated when the client renews, rebinds, or confirms the prefix delegation. A binding table entry is deleted when the client releases all the prefixes in the binding voluntarily, all prefixes' valid lifetimes have expired, or administrators run the **clear ipv6 dhcp binding** command.

Binding Database

The automatic bindings are maintained in RAM and can be saved to some permanent storage so that the information about configuration such as prefixes assigned to clients is not lost after a system reload or power down. The bindings are stored as text records for easy maintenance. Each record contains the following information:

- DHCP for IPv6 pool name from which the configuration was assigned to the client
- Interface identifier from which the client requests were received
- The client IPv6 address
- The client DUID
- IAID of the IAPD
- Prefix delegated to the client
- The prefix length
- The prefix preferred lifetime in seconds
- The prefix valid lifetime in seconds
- The prefix expiration time stamp
- Optional local prefix pool name from which the prefix was assigned

At the beginning of the file, before the text records, a time stamp records the time when the database is written and a version number, which helps differentiate between newer and older databases. At the end of the file, after the text records, the text string “*end*” is stored to detect file truncation.

The permanent storage to which the binding database is saved is called the database agent. Database agents include FTP and TFTP servers, RCP, flash file system, and NVRAM.

DHCP Relay Agent

A DHCP relay agent, which may reside on the client's link, is used to relay messages between the client and server. DHCP relay agent operation is transparent to the client. A client locates a DHCP server using a reserved, link-scoped multicast address. Therefore, it is a requirement for direct communication between the client and the server that the client and the server be attached to the same link. However, in some situations in which ease of management, economy, or scalability is a concern, it is desirable to allow a DHCP client to send a message to a DHCP server that is not connected to the same link.

How to Implement DHCP for IPv6

The tasks in the following sections explain how to implement DHCP for IPv6:

- [Configuring the DHCP for IPv6 Server Function, page 144](#)
- [Configuring the DHCP for IPv6 Client Function, page 145](#)
- [Configuring the DHCP for IPv6 Relay Agent, page 146](#)
- [Configuring a Database Agent for the Server Function, page 147](#)
- [Configuring the Stateless DHCP for IPv6 Function, page 148](#)
- [Defining a General Prefix with the DHCP for IPv6 Prefix Delegation Client Function, page 151](#)
- [Restarting the DHCP for IPv6 Client on an Interface, page 152](#)
- [Deleting Automatic Client Bindings from the DHCP for IPv6 Binding Table, page 152](#)
- [Troubleshooting DHCP for IPv6, page 153](#)

Configuring the DHCP for IPv6 Server Function

This task explains how to create and configure the DHCP for IPv6 configuration pool and associate the pool with a server on an interface.

SUMMARY STEPS

1. **enable**
2. **configure terminal**
3. **ipv6 dhcp pool** *poolname*
4. **domain-name** *domain*
5. **dns-server** *ipv6-address*
6. **prefix-delegation** *ipv6-prefix/prefix-length client-DUID* [**iaid** *iaid*] [*lifetime*]
7. **prefix-delegation pool** *poolname* [**lifetime** {*valid-lifetime* | *preferred-lifetime*}]
8. **exit**
9. **interface** *type number*
10. **ipv6 dhcp server** *poolname* [**rapid-commit**] [**preference** *value*] [**allow-hint**]

DETAILED STEPS

	Command or Action	Purpose
Step 1	enable Example: Router> enable	Enables privileged EXEC mode. <ul style="list-style-type: none"> • Enter your password if prompted.
Step 2	configure terminal Example: Router# configure terminal	Enters global configuration mode.

	Command or Action	Purpose
Step 3	<code>ipv6 dhcp pool poolname</code> Example: Router(config)# ipv6 dhcp pool pool1	Configures a DHCP for IPv6 configuration information pool and enters DHCP for IPv6 pool configuration mode.
Step 4	<code>domain-name domain</code> Example: Router(config-dhcp)# domain-name example.com	Configures a domain name for a DHCP for IPv6 client.
Step 5	<code>dns-server ipv6-address</code> Example: Router(config-dhcp)# dns-server 2001:0DB8:3000:3000::42	Specifies the DNS IPv6 servers available to a DHCP for IPv6 client.
Step 6	<code>prefix-delegation ipv6-prefix/prefix-length client-DUID [iaid iaid] [lifetime]</code> Example: Router(config-dhcp)# prefix-delegation 2001:0DB8:1263::/48 0005000400F1A4D070D03	Specifies a manually configured numeric prefix to be delegated to a specified client's IAPD.
Step 7	<code>prefix-delegation pool poolname [lifetime {valid-lifetime preferred-lifetime}]</code> Example: Router(config-dhcp)# prefix-delegation pool prefix-pool 1800 60	Specifies a named IPv6 local prefix pool from which prefixes are delegated to DHCP for IPv6 clients.
Step 8	<code>exit</code> Example: Router(config-dhcp)# exit	Exits DHCP for IPv6 pool configuration mode configuration mode, and returns the router to global configuration mode.
Step 9	<code>interface type number</code> Example: Router(config)# interface serial 3	Specifies an interface type and number, and places the router in interface configuration mode.
Step 10	<code>ipv6 dhcp server poolname [rapid-commit] [preference value] [allow-hint]</code> Example: Router(config-if)# ipv6 dhcp server dhcp-pool	Enables DHCP for IPv6 on an interface.

Configuring the DHCP for IPv6 Client Function

General prefixes can be defined dynamically from a prefix received by a DHCP for IPv6 prefix delegation client. This task shows how to configure the DHCP for IPv6 client function on an interface and enable prefix delegation on an interface. The delegated prefix is stored in a general prefix.

SUMMARY STEPS

1. **enable**
2. **configure terminal**
3. **interface** *type number*
4. **ipv6 dhcp client pd** *prefix-name* [**rapid-commit**]

DETAILED STEPS

	Command or Action	Purpose
Step 1	enable Example: Router> enable	Enables privileged EXEC mode. <ul style="list-style-type: none"> • Enter your password if prompted.
Step 2	configure terminal Example: Router# configure terminal	Enters global configuration mode.
Step 3	interface <i>type number</i> Example: Router(config)# interface ethernet 0/0	Specifies an interface type and number, and places the router in interface configuration mode.
Step 4	ipv6 dhcp client pd <i>prefix-name</i> [rapid-commit] Example: Router(config-if)# ipv6 dhcp client pd dhcp-prefix	Enables the DHCP for IPv6 client process and enables a request for prefix delegation through a specified interface.

Configuring the DHCP for IPv6 Relay Agent

This task describes how to enable the DHCP for IPv6 relay agent function and specify relay destination addresses on an interface.

SUMMARY STEPS

1. **enable**
2. **configure terminal**
3. **interface** *type number*
4. **ipv6 dhcp relay destination** *ipv6-address* [*interface-type interface-number*]

DETAILED STEPS

	Command or Action	Purpose
Step 1	enable Example: Router> enable	Enables privileged EXEC mode. <ul style="list-style-type: none"> Enter your password if prompted.
Step 2	configure terminal Example: Router# configure terminal	Enters global configuration mode.
Step 3	interface <i>type number</i> Example: Router(config)# interface ethernet 4/2	Specifies an interface type and number, and places the router in interface configuration mode.
Step 4	ipv6 dhcp relay destination <i>ipv6-address</i> [<i>interface-type interface-number</i>] Example: Router(config-if) ipv6 dhcp relay destination FE80::250:A2FF:FEBF:A056 ethernet 4/3	Specifies a destination address to which client messages are forwarded and enables DHCP for IPv6 relay service on the interface.

Configuring a Database Agent for the Server Function

This task shows how to configure a DHCP for IPv6 binding database agent for the server function.

SUMMARY STEPS

- enable**
- configure terminal**
- ipv6 dhcp database** *agent-URL* [*write-delay seconds*] [*timeout seconds*]

DETAILED STEPS

	Command or Action	Purpose
Step 1	enable Example: Router> enable	Enables privileged EXEC mode. <ul style="list-style-type: none"> Enter your password if prompted.
Step 2	configure terminal Example: Router# configure terminal	Enters global configuration mode.
Step 3	ipv6 dhcp database agent-URL [write-delay seconds] [timeout seconds] Example: Router(config)# ipv6 dhcp database tftp://10.0.0.1/dhcp-binding	Specifies DHCP for IPv6 binding database agent parameters.

Configuring the Stateless DHCP for IPv6 Function

The following tasks describe how to use the DHCP for IPv6 function to configure clients with information about the name lookup system. The server maintains no state related to clients; for example, no prefix pools and records of allocation are maintained. Therefore, this function is “stateless” DHCP for IPv6.

- [Configuring the Stateless DHCP for IPv6 Server, page 148](#)
- [Configuring the Stateless DHCP for IPv6 Client, page 150](#)
- [Enabling Processing of Packets with Source Routing Header Options, page 150](#)

Configuring the Stateless DHCP for IPv6 Server

The following task describes how to configure the stateless DHCP for IPv6 server.

SUMMARY STEPS

1. **enable**
2. **configure terminal**
3. **ipv6 dhcp pool** *poolname*
4. **dns-server** *ipv6-address*
5. **domain-name** *domain*
6. **exit**
7. **interface** *type number*
8. **ipv6 dhcp server** *poolname* [**rapid-commit**] [**preference** *value*] [**allow-hint**]
9. **ipv6 nd other-config-flag**

DETAILED STEPS

	Command or Action	Purpose
Step 1	enable Example: Router> enable	Enables privileged EXEC mode. <ul style="list-style-type: none"> Enter your password if prompted.
Step 2	configure terminal Example: Router# configure terminal	Enters global configuration mode.
Step 3	ipv6 dhcp pool poolname Example: Router(config)# ipv6 dhcp pool dhcp-pool	Configures a DHCP for IPv6 configuration information pool and enters DHCP for IPv6 pool configuration mode.
Step 4	dns-server ipv6-address Example: Router(config-dhcp) dns-server 2001:0DB8:3000:3000::42	Specifies the DNS IPv6 servers available to a DHCP for IPv6 client.
Step 5	domain-name domain Example: Router(config-dhcp)# domain-name domain1.com	Configures a domain name for a DHCP for IPv6 client.
Step 6	exit Example: Router(config-dhcp)# exit	Exits DHCP for IPv6 pool configuration mode configuration mode, and returns the router to global configuration mode.
Step 7	interface type number Example: Router(config)# interface serial 3	Specifies an interface type and number, and places the router in interface configuration mode.
Step 8	ipv6 dhcp server poolname [rapid-commit] [preference value] [allow-hint] Example: Router(config-if)# ipv6 dhcp server dhcp-pool	Enables DHCP for IPv6 on an interface.
Step 9	ipv6 nd other-config-flag Example: Router(config-if)# ipv6 nd other-config-flag	Sets the “other stateful configuration” flag in IPv6 RAs.

Configuring the Stateless DHCP for IPv6 Client

The following task describes how to configure the stateless DHCP for IPv6 client.

SUMMARY STEPS

1. **enable**
2. **configure terminal**
3. **interface** *type number*
4. **ipv6 address autoconfig** [default]

DETAILED STEPS

	Command or Action	Purpose
Step 1	enable Example: Router> enable	Enables privileged EXEC mode. <ul style="list-style-type: none"> • Enter your password if prompted.
Step 2	configure terminal Example: Router# configure terminal	Enters global configuration mode.
Step 3	interface <i>type number</i> Example: Router(config)# interface serial 3	Specifies an interface type and number, and places the router in interface configuration mode.
Step 4	ipv6 address autoconfig [default] Example: Router(config-if)# ipv6 address autoconfig	Enables automatic configuration of IPv6 addresses using stateless autoconfiguration on an interface and enables IPv6 processing on the interface.

Enabling Processing of Packets with Source Routing Header Options

The following task describes how to enable the processing of packets with source routing header options.

SUMMARY STEPS

1. **enable**
2. **configure terminal**
3. **ipv6 source-route**

DETAILED STEPS

	Command or Action	Purpose
Step 1	enable Example: Router> enable	Enables privileged EXEC mode. <ul style="list-style-type: none"> Enter your password if prompted.
Step 2	configure terminal Example: Router# configure terminal	Enters global configuration mode.
Step 3	ipv6 source-route Example: Router(config)# ipv6 source-route	Enables processing of the IPv6 type 0 routing header.

Defining a General Prefix with the DHCP for IPv6 Prefix Delegation Client Function

The following task describes how to configure the DHCP for IPv6 client function on an interface and enable prefix delegation on an interface. The delegated prefix is stored in a general prefix.

SUMMARY STEPS

1. **enable**
2. **configure terminal**
3. **interface** *type number*
4. **ipv6 dhcp client pd** *prefix-name* [**rapid-commit**]

DETAILED STEPS

	Command or Action	Purpose
Step 1	enable Example: Router> enable	Enables privileged EXEC mode. <ul style="list-style-type: none"> Enter your password if prompted.
Step 2	configure terminal Example: Router# configure terminal	Enters global configuration mode.

	Command or Action	Purpose
Step 3	<code>interface type number</code> Example: Router(config)# interface ethernet 0/0	Specifies an interface type and number, and places the router in interface configuration mode.
Step 4	<code>ipv6 dhcp client pd prefix-name [rapid-commit]</code> Example: Router(config-if)# ipv6 dhcp client pd dhcp-prefix	Enables the DHCP for IPv6 client process and enables a request for prefix delegation through a specified interface. The delegated prefix is stored in the general prefix <i>prefix-name</i> argument.

Restarting the DHCP for IPv6 Client on an Interface

This task explains how to restart the DHCP for IPv6 client on a specified interface after first releasing and unconfiguring previously acquired prefixes and other configuration options.

SUMMARY STEPS

1. `enable`
2. `clear ipv6 dhcp client interface-type interface-number`

DETAILED STEPS

	Command or Action	Purpose
Step 1	<code>enable</code> Example: Router> enable	Enables privileged EXEC mode. <ul style="list-style-type: none"> • Enter your password if prompted.
Step 2	<code>clear ipv6 dhcp client interface-type interface-number</code> Example: Router# clear ipv6 dhcp client Ethernet 1/0	Restarts DHCP for IPv6 client on an interface.

Deleting Automatic Client Bindings from the DHCP for IPv6 Binding Table

This task explains how to delete automatic client bindings from the DHCP for IPv6 binding table.

SUMMARY STEPS

1. `enable`
2. `clear ipv6 dhcp binding [ipv6-address]`

DETAILED STEPS

	Command or Action	Purpose
Step 1	enable Example: Router> enable	Enables privileged EXEC mode. <ul style="list-style-type: none"> Enter your password if prompted.
Step 2	clear ipv6 dhcp binding [ipv6-address] Example: Router# clear ipv6 dhcp binding	Deletes automatic client bindings from the DHCP for IPv6 binding table.

Troubleshooting DHCP for IPv6

This task provides commands you can use as needed to troubleshoot your DHCP for IPv6 configuration.

SUMMARY STEPS

1. **enable**
2. **debug ipv6 dhcp** [detail]
3. **debug ipv6 dhcp database**
4. **debug ipv6 dhcp relay**

DETAILED STEPS

	Command or Action	Purpose
Step 1	enable Example: Router> enable	Enables privileged EXEC mode. <ul style="list-style-type: none"> Enter your password if prompted.
Step 2	debug ipv6 dhcp [detail] Example: Router# debug ipv6 dhcp	Enables debugging for DHCP for IPv6.
Step 3	debug ipv6 dhcp database Example: Router# debug ipv6 dhcp database	Enables debugging for the DHCP for IPv6 binding database.
Step 4	debug ipv6 dhcp relay Example: Router# debug ipv6 dhcp relay	Enables DHCP for IPv6 relay agent debugging.

Verifying DHCP for IPv6 Configuration and Operation

This task explains how to display information to verify DHCP for IPv6 configuration and operation. These commands do not need to be entered in any specific order.

SUMMARY STEPS

1. **enable**
2. **show ipv6 dhcp**
3. **show ipv6 dhcp binding** [*ipv6-address*]
4. **show ipv6 dhcp database** [*agent-URL*]
5. **show ipv6 dhcp interface** [*interface-type interface-number*]
6. **show ipv6 dhcp pool** [*poolname*]
7. **show running-config**

DETAILED STEPS

	Command or Action	Purpose
Step 1	enable Example: Router# enable	Enables privileged EXEC mode. <ul style="list-style-type: none"> • Enter your password if prompted.
Step 2	show ipv6 dhcp Example: Router# show ipv6 dhcp	Displays the DUID on a specified device.
Step 3	show ipv6 dhcp binding [<i>ipv6-address</i>] Example: Router# show ipv6 dhcp binding	Displays automatic client bindings from the DHCP for IPv6 database.
Step 4	show ipv6 dhcp database [<i>agent-URL</i>] Example: Router# show ipv6 dhcp database	Displays the DHCP for IPv6 binding database agent information.
Step 5	show ipv6 dhcp interface [<i>interface-type interface-number</i>] Example: Router# show ipv6 dhcp interface	Displays DHCP for IPv6 interface information.

	Command or Action	Purpose
Step 6	<code>show ipv6 dhcp pool [poolname]</code> Example: Router# show ipv6 dhcp pool	Displays DHCP for IPv6 configuration pool information.
Step 7	<code>show running-config</code> Example: Router# show running-config	Displays the current configuration running on the router.

Examples

This section provides the following output examples:

- [Sample Output for the show ipv6 dhcp Command, page 155](#)
- [Sample Output for the show ipv6 dhcp binding Command, page 155](#)
- [Sample Output for the show ipv6 dhcp database Command, page 155](#)
- [Sample Output for the show ipv6 dhcp interface Command, page 156](#)
- [Sample Output for the show ipv6 dhcp pool Command, page 157](#)

Sample Output for the show ipv6 dhcp Command

The following example from the `show ipv6 dhcp` command shows the DUID of the device:

```
Router# show ipv6 dhcp
```

```
This device's DHCPv6 unique identifier(DUID): 000300010002FCA5DC1C
```

Sample Output for the show ipv6 dhcp binding Command

In the following example, the `show ipv6 dhcp binding` command shows information about two clients, including their DUIDs, IAPDs, prefixes, and preferred and valid lifetimes:

```
Router# show ipv6 dhcp binding
```

```
Client: FE80::202:FCFF:FEA5:DC39 (Ethernet2/1)
  DUID: 000300010002FCA5DC1C
  IA PD: IA ID 0x00040001, T1 0, T2 0
    Prefix: 3FFE:C00:C18:11::/68
      preferred lifetime 180, valid lifetime 12345
      expires at Nov 08 2002 02:24 PM (12320 seconds)
Client: FE80::202:FCFF:FEA5:C039 (Ethernet2/1)
  DUID: 000300010002FCA5C01C
  IA PD: IA ID 0x00040001, T1 0, T2 0
    Prefix: 3FFE:C00:C18:1::/72
      preferred lifetime 240, valid lifetime 54321
      expires at Nov 09 2002 02:02 AM (54246 seconds)
    Prefix: 3FFE:C00:C18:2::/72
      preferred lifetime 300, valid lifetime 54333
      expires at Nov 09 2002 02:03 AM (54258 seconds)
    Prefix: 3FFE:C00:C18:3::/72
      preferred lifetime 280, valid lifetime 51111
```

Sample Output for the show ipv6 dhcp database Command

In the following example, the `show ipv6 dhcp database` command provides information on the binding database agents TFTP, NVRAM, and flash:

```

Router# show ipv6 dhcp database

Database agent tftp://172.19.216.133/db.tftp:
  write delay: 69 seconds, transfer timeout: 300 seconds
  last written at Jan 09 2003 01:54 PM,
    write timer expires in 56 seconds
  last read at Jan 06 2003 05:41 PM
  successful read times 1
  failed read times 0
  successful write times 3172
  failed write times 2
Database agent nvram:/dhcpv6-binding:
  write delay: 60 seconds, transfer timeout: 300 seconds
  last written at Jan 09 2003 01:54 PM,
    write timer expires in 37 seconds
  last read at never
  successful read times 0
  failed read times 0
  successful write times 3325
  failed write times 0
Database agent flash:/dhcpv6-db:
  write delay: 82 seconds, transfer timeout: 3 seconds
  last written at Jan 09 2003 01:54 PM,
    write timer expires in 50 seconds
  last read at never
  successful read times 0
  failed read times 0
  successful write times 2220
  failed write times 614

```

Sample Output for the show ipv6 dhcp interface Command

The following is sample output from the **show ipv6 dhcp interface** command. In the first example, the command is used on a router that has an interface acting as a DHCP for IPv6 server. In the second example, the command is used on a router that has an interface acting as a DHCP for IPv6 client:

```

Router1# show ipv6 dhcp interface

Ethernet2/1 is in server mode
  Using pool: svr-p1
  Preference value: 20
  Rapid-Commit is disabled

Router2# show ipv6 dhcp interface

Ethernet2/1 is in client mode
  State is OPEN (1)
  List of known servers:
    Address: FE80::202:FCFF:FEA1:7439, DUID 000300010002FCA17400
    Preference: 20
      IA PD: IA ID 0x00040001, T1 120, T2 192
        Prefix: 3FFE:C00:C18:1::/72
          preferred lifetime 240, valid lifetime 54321
          expires at Nov 08 2002 09:10 AM (54319 seconds)
        Prefix: 3FFE:C00:C18:2::/72
          preferred lifetime 300, valid lifetime 54333
          expires at Nov 08 2002 09:11 AM (54331 seconds)
        Prefix: 3FFE:C00:C18:3::/72
          preferred lifetime 280, valid lifetime 51111
          expires at Nov 08 2002 08:17 AM (51109 seconds)
    DNS server: 2001:0DB8:1001::1
    DNS server: 2001:0DB8:1001::2
    Domain name: example1.net
    Domain name: example2.net

```

```

Domain name: example3.net
Prefix name is cli-p1
Rapid-Commit is enabled

```

Sample Output for the show ipv6 dhcp pool Command

In the following example, the **show ipv6 dhcp pool** command provides information on the configuration pool named svr-p1, including the static bindings, prefix information, the DNS server, and the domain names found in the svr-p1 pool:

```

Router# show ipv6 dhcp pool

DHCPv6 pool: svr-p1
Static bindings:
  Binding for client 000300010002FCA5C01C
    IA PD: IA ID 00040002,
      Prefix: 3FFE:C00:C18:3::/72
            preferred lifetime 604800, valid lifetime 2592000
    IA PD: IA ID not specified; being used by 00040001
      Prefix: 3FFE:C00:C18:1::/72
            preferred lifetime 240, valid lifetime 54321
      Prefix: 3FFE:C00:C18:2::/72
            preferred lifetime 300, valid lifetime 54333
      Prefix: 3FFE:C00:C18:3::/72
            preferred lifetime 280, valid lifetime 51111
    Prefix from pool: local-p1, Valid lifetime 12345, Preferred lifetime 180
  DNS server: 2001:0DB8:1001::1
  DNS server: 2001:0DB8:1001::2
  Domain name: example1.net
  Domain name: example2.net
  Domain name: example3.net
Active clients: 2
Current configuration : 22324 bytes
!
! Last configuration change at 14:59:38 PST Tue Jan 16 2001
! NVRAM config last updated at 04:25:39 PST Tue Jan 16 2001 by bird
!
hostname Router
!
ip cef
ipv6 unicast-routing
ipv6 cef
ipv6 cef accounting prefix-length
!
!
interface Ethernet0
 ip address 10.4.9.11 255.0.0.0
 media-type 10BaseT
 ipv6 address 2001:0DB8:C18:1::/64 eui-64

```

Configuration Examples for Implementing DHCP for IPv6

This section provides the following DHCP for IPv6 mapping configuration examples:

- [Configuring the DHCP for IPv6 Server Function: Example, page 158](#)
- [Configuring the DHCP for IPv6 Client Function: Example, page 158](#)
- [Configuring a Database Agent for the Server Function: Example, page 158](#)
- [Configuring the Stateless DHCP for IPv6 Function: Example, page 159](#)

Configuring the DHCP for IPv6 Server Function: Example

DHCP for IPv6 clients are connected to this server on Ethernet interface 0/0. The server is configured to use parameters from the DHCP pool called dhcp-pool. This pool provides clients with the IPv6 address of a DNS server and the domain name to be used. It also specifies that prefixes can be delegated from the prefix pool called client-prefix-pool1. The prefixes delegated will have valid and preferred lifetimes of 1800 and 600 seconds. The prefix pool named client-prefix-pool1 has a prefix of length /40 from which it will delegate (sub)prefixes of length /48.

```
ipv6 dhcp pool dhcp-pool
 prefix-delegation pool client-prefix-pool1 lifetime 1800 600
 dns-server 2001:0DB8:3000:3000::42
 domain-name examplecom
!
interface Ethernet0/0
 description downlink to clients
 ipv6 address FEC0:240:104:2001::139/64
 ipv6 dhcp server dhcp-pool
!
ipv6 local pool client-prefix-pool1 2001:0DB8:1200::/40 48
```

Configuring the DHCP for IPv6 Client Function: Example

This DHCP for IPv6 client has three interfaces: Ethernet interface 0/0 is the upstream link to a service provider, which has a DHCP for IPv6 server function enabled. The FastEthernet interfaces 0/0 and 0/1 are links to local networks.

The upstream interface, Ethernet interface 0/0, has the DHCP for IPv6 client function enabled. Prefixes delegated by the provider are stored in the general prefix called prefix-from-provider.

The local networks, FastEthernet interfaces 0/0 and 0/1, both assign interface addresses based on the general prefix called prefix-from-provider. The leftmost bits of the addresses come from the general prefix, and the rightmost bits are specified statically.

```
interface Ethernet 0/0
 description uplink to provider DHCP IPv6 server
 ipv6 dhcp client pd prefix-from-provider
!
interface FastEthernet 0/0
 description local network 0
 ipv6 address prefix-from-provider ::5:0:0:0:100/64
!
interface FastEthernet 0/1
 description local network 1
 ipv6 address prefix-from-provider ::6:0:0:0:100/64
```

Configuring a Database Agent for the Server Function: Example

The DHCP for IPv6 server is configured to store table bindings to the file named dhcp-binding on the server at address 10.0.0.1 using the TFTP protocol. The bindings are saved every 120 seconds.

```
ipv6 dhcp database tftp://10.0.0.1/dhcp-binding write-delay 120
```

Configuring the Stateless DHCP for IPv6 Function: Example

This example uses the DHCP for IPv6 function to configure clients with information about the name lookup system. The server is configured with a DHCP pool, which contains name lookup information to be passed to clients. It does not need to contain a prefix pool. This DHCP pool is attached to the access link to customers (Ethernet0/0) using the **ipv6 dhcp server** command. The access link also has the **ipv6 nd other-config-flag** command enabled. RA messages sent from this interface will inform clients that they should use DHCP for IPv6 for “other” (for example, nonaddress) configuration information.

```
ipv6 dhcp pool dhcp-pool
  dns-server 2001:0DB8:A:B::1
  dns-server 2001:0DB8:3000:3000::42
  domain-name example.com
!
interface Ethernet0/0
  description Access link down to customers
  ipv6 address 2001:0DB8:1234:42::1/64
  ipv6 nd other-config-flag
  ipv6 dhcp server dhcp-pool
```

The client has no obvious DHCP for IPv6 configuration. However, the **ipv6 address autoconfig** command on the uplink to the service provider (Ethernet 0/0) causes two things to happen:

- Addresses are autoconfigured on the interface, based on prefixes in RA messages received from the server.
- If received RA messages have the “other configuration” flag set, the interface will attempt to acquire other (for example, nonaddress) configuration from any DHCP for IPv6 servers.

```
interface Ethernet 0/0
  description Access link up to provider
  ipv6 address autoconfig
```

Additional References

The following sections provide references related to implementing DHCP for IPv6:

Related Documents

Related Topic	Document Title
IPv6 supported feature list	<i>Start Here: Cisco IOS Software Release Specifics for IPv6 Features</i>
IPv6 basic connectivity	<i>Implementing IPv6 Addressing and Basic Connectivity</i>
IPv6 prefix delegation	<ul style="list-style-type: none"> • <i>Implementing IPv6 Addressing and Basic Connectivity</i> • <i>Implementing ADSL and Deploying Dial Access for IPv6</i>
IPv6 commands: complete command syntax, command mode, defaults, usage guidelines, and examples	<i>Cisco IOS IPv6 Command Reference</i>
IPv4 configuration and command reference information	Cisco IOS Release 12.4 Configuration Guides and Command References

Standards

Standards	Title
No new or modified standards are supported by this feature, and support for existing standards has not been modified by this feature.	—

MIBs

MIBs	MIBs Link
No new or modified MIBs are supported by this feature, and support for existing MIBs has not been modified by this feature.	To locate and download MIBs for selected platforms, Cisco IOS releases, and feature sets, use Cisco MIB Locator found at the following URL: http://www.cisco.com/go/mibs

RFCs

RFCs	Title
RFC 3315	<i>Dynamic Host Configuration Protocol for IPv6</i>
RFC 3633	<i>IPv6 Prefix Options for Dynamic Host Configuration Protocol (DHCP) version 6</i>
RFC 3646	<i>DNS Configuration Options for Dynamic Host Configuration Protocol for IPv6 (DHCPv6)</i>

Technical Assistance

Description	Link
The Cisco Technical Support & Documentation website contains thousands of pages of searchable technical content, including links to products, technologies, solutions, technical tips, and tools. Registered Cisco.com users can log in from this page to access even more content.	http://www.cisco.com/techsupport

Feature Information for Implementing DHCP for IPv6

Table 13 lists the features in this module and provides links to specific configuration information. Only features that were introduced or modified in Cisco IOS Release 12.2(2)T or a later release appear in the table.

For information on a feature in this technology that is not documented here, see “Start Here: Cisco IOS Software Release Specifies for IPv6 Features.”

Not all commands may be available in your Cisco IOS software release. For release information about a specific command, see the command reference documentation.

Cisco IOS software images are specific to a Cisco IOS software release, a feature set, and a platform. Use Cisco Feature Navigator to find information about platform support and Cisco IOS software image support. Access Cisco Feature Navigator at <http://www.cisco.com/go/fn>. You must have an account on Cisco.com. If you do not have an account or have forgotten your username or password, click **Cancel** at the login dialog box and follow the instructions that appear.

**Note**

Table 13 lists only the Cisco IOS software release that introduced support for a given feature in a given Cisco IOS software release train. Unless noted otherwise, subsequent releases of that Cisco IOS software release train also support that feature.

Table 13 Feature Information for Implementing DHCP for IPv6

Feature Name	Releases	Feature Information
IPv6 access services: DHCPv6 prefix delegation	12.0(32)S, 12.2(28)SB, 12.2(33)SRA, 12.2(18)SXE, 12.3(4)T, 12.4, 12.4(2)T	<p>The DHCP for IPv6 prefix delegation feature can be used to manage link, subnet, and site addressing changes. DHCP for IPv6 can be used in environments to deliver stateful and stateless information.</p> <p>The following sections provide information about this feature:</p> <ul style="list-style-type: none"> • DHCP for IPv6 Prefix Delegation, page 140 • Configuring the DHCP for IPv6 Server Function, page 144 • Configuring the DHCP for IPv6 Client Function, page 145 • Configuring the DHCP for IPv6 Server Function: Example, page 158 • Configuring the DHCP for IPv6 Client Function: Example, page 158
IPv6 access services: stateless DHCPv6	12.3(4)T, 12.4, 12.4(2)T	<p>Stateless DHCP for IPv6 allows DHCP for IPv6 to be used for configuring a node with parameters that do not require a server to maintain any dynamic state for the node.</p> <p>The following sections provide information about this feature:</p> <ul style="list-style-type: none"> • DHCP for IPv6 Prefix Delegation, page 140 • Configuring Nodes Without Prefix Delegation, page 140 • Configuring the Stateless DHCP for IPv6 Function, page 148 • Configuring the Stateless DHCP for IPv6 Function: Example, page 159
IPv6 access services: DHCP for IPv6 relay agent	12.2(28)SB, 12.3(11)T, 12.4, 12.4(2)T	<p>A DHCP relay agent, which may reside on the client's link, is used to relay messages between the client and server.</p> <p>The following sections provide information about this feature:</p> <ul style="list-style-type: none"> • DHCP Relay Agent, page 143 • Configuring the DHCP for IPv6 Relay Agent, page 146



Implementing EIGRP for IPv6

First Published: February 27, 2006

Last Updated: February 27, 2006

Customers can configure Enhanced Interior Gateway Routing Protocol (EIGRP) to route IPv6 prefixes. EIGRP IPv4 runs over an IPv4 transport, communicates only with IPv4 peers, and advertises only IPv4 routes, and EIGRP for IPv6 follows the same model. EIGRP for IPv4 and EIGRP for IPv6 are configured and managed separately. However, the configuration of EIGRP for IPv4 and IPv6 is similar and provides operational familiarity and continuity.

Finding Feature Information in This Module

Your Cisco IOS software release may not support all of the features documented in this module. To reach links to specific feature documentation in this module and to see a list of the releases in which each feature is supported, use the [“Feature Information for Implementing EIGRP for IPv6”](#) section on page 186.

Finding Support Information for Platforms and Cisco IOS Software Images

Use Cisco Feature Navigator to find information about platform support and Cisco IOS software image support. Access Cisco Feature Navigator at <http://www.cisco.com/go/fn>. You must have an account on Cisco.com. If you do not have an account or have forgotten your username or password, click **Cancel** at the login dialog box and follow the instructions that appear.

Contents

- [Prerequisites for Implementing EIGRP for IPv6, page 164](#)
- [Restrictions for Implementing EIGRP for IPv6, page 164](#)
- [Information About Implementing EIGRP for IPv6, page 164](#)
- [How to Implement EIGRP for IPv6, page 166](#)
- [Configuration Examples for Implementing EIGRP for IPv6, page 183](#)
- [Where to Go Next, page 184](#)
- [Additional References, page 184](#)
- [Feature Information for Implementing EIGRP for IPv6, page 186](#)

Prerequisites for Implementing EIGRP for IPv6

This document assumes that you are familiar with EIGRP IPv4.

This document assumes that users have a basic knowledge of IPv6 addressing.

Restrictions for Implementing EIGRP for IPv6

This section lists ways in which EIGRP for IPv6 differs from EIGRP IPv4 as well as EIGRP for IPv6 restrictions.

- EIGRP for IPv6 is directly configured on the interfaces over which it runs. This feature allows EIGRP for IPv6 to be configured without the use of a global IPv6 address. There is no network statement in EIGRP for IPv6.

In per-interface configuration at system startup, if EIGRP has been configured on an interface, then the EIGRP protocol may start running before any EIGRP router mode commands have been executed.
- An EIGRP for IPv6 protocol instance requires a router ID before it can start running.
- EIGRP for IPv6 has a shutdown feature. The routing process should be in “no shutdown” mode in order to start running.
- When a user uses passive-interface configuration, EIGRP for IPv6 does not need to be configured on the interface that is made passive.
- EIGRP for IPv6 provides route filtering using the **distribute-list prefix-list** command. Use of the **route-map** command is not supported for route filtering with a distribute list.

Information About Implementing EIGRP for IPv6

To configure EIGRP for IPv6 in Cisco IOS, you should understand the following concepts:

- [Cisco EIGRP for IPv6 Implementation, page 164](#)

Cisco EIGRP for IPv6 Implementation

EIGRP is an enhanced version of the IGRP developed by Cisco. EIGRP uses the same distance vector algorithm and distance information as IGRP. However, the convergence properties and the operating efficiency of EIGRP have improved substantially over IGRP.

The convergence technology is based on research conducted at SRI International and employs an algorithm referred to as the diffusing update algorithm (DUAL). This algorithm guarantees loop-free operation at every instant throughout a route computation and allows all devices involved in a topology change to synchronize at the same time. Routers that are not affected by topology changes are not involved in recomputations. The convergence time with DUAL rivals that of any other existing routing protocol.

EIGRP provides the following features:

- Increased network width—With Routing Information Protocol (RIP), the largest possible width of your network is 15 hops. When EIGRP is enabled, the largest possible width is 224 hops. Because the EIGRP metric is large enough to support thousands of hops, the only barrier to expanding the

network is the transport layer hop counter. Cisco works around this problem by incrementing the transport control field only when an IPv4 or an IPv6 packet has traversed 15 routers and the next hop to the destination was learned by way of EIGRP. When a RIP route is being used as the next hop to the destination, the transport control field is incremented as usual.

- Fast convergence—The DUAL algorithm allows routing information to converge as quickly as any other routing protocol.
- Partial updates—EIGRP sends incremental updates when the state of a destination changes, instead of sending the entire contents of the routing table. This feature minimizes the bandwidth required for EIGRP packets.
- Neighbor discovery mechanism—This is a simple hello mechanism used to learn about neighboring routers. It is protocol-independent.
- Arbitrary route summarization.
- Scaling—EIGRP scales to large networks.
- Route filtering—EIGRP for IPv6 provides route filtering using the **distribute-list prefix-list** command. Use of the **route-map** command is not supported for route filtering with a distribute list.

EIGRP has the following four basic components:

- Neighbor discovery—Neighbor discovery is the process that routers use to dynamically learn of other routers on their directly attached networks. Routers must also discover when their neighbors become unreachable or inoperative. EIGRP neighbor discovery is achieved with low overhead by periodically sending small hello packets. EIGRP neighbors can also discover a neighbor that has recovered after an outage because the recovered neighbor will send out a hello packet. As long as hello packets are received, the Cisco IOS software can determine that a neighbor is alive and functioning. Once this status is determined, the neighboring routers can exchange routing information.
- Reliable transport protocol—The reliable transport protocol is responsible for guaranteed, ordered delivery of EIGRP packets to all neighbors. It supports intermixed transmission of multicast and unicast packets. Some EIGRP packets must be sent reliably and others need not be. For efficiency, reliability is provided only when necessary. For example, on a multiaccess network that has multicast capabilities (such as Ethernet) it is not necessary to send hello packets reliably to all neighbors individually. Therefore, EIGRP sends a single multicast hello with an indication in the packet informing the receivers that the packet need not be acknowledged. Other types of packets (such as updates) require acknowledgment, which is indicated in the packet. The reliable transport has a provision to send multicast packets quickly when unacknowledged packets are pending. This provision helps to ensure that convergence time remains low in the presence of varying speed links.
- DUAL finite state machine—The DUAL finite state machine embodies the decision process for all route computations. It tracks all routes advertised by all neighbors. DUAL uses several metrics including distance and cost information to select efficient, loop-free paths. When multiple routes to a neighbor exist, DUAL determines which route has the lowest metric (named the feasible distance), and enters this route into the routing table. Other possible routes to this neighbor with larger metrics are received, and DUAL determines the reported distance to this network. The reported distance is defined as the total metric advertised by an upstream neighbor for a path to a destination. DUAL compares the reported distance with the feasible distance, and if the reported distance is less than the feasible distance, DUAL considers the route to be a feasible successor and enters the route into the topology table. The feasible successor route that is reported with the lowest metric becomes the successor route to the current route if the current route fails. To avoid routing loops, DUAL ensures that the reported distance is always less than the feasible distance for a neighbor router to reach the destination network; otherwise, the route to the neighbor may loop back through the local router.

- Protocol-dependent modules—When there are no feasible successors to a route that has failed, but there are neighbors advertising the route, a recomputation must occur. This is the process where DUAL determines a new successor. The amount of time required to recompute the route affects the convergence time. Recomputation is processor-intensive; it is advantageous to avoid unneeded recomputation. When a topology change occurs, DUAL will test for feasible successors. If there are feasible successors, DUAL will use them in order to avoid unnecessary recomputation.

The protocol-dependent modules are responsible for network layer protocol-specific tasks. An example is the EIGRP module, which is responsible for sending and receiving EIGRP packets that are encapsulated in IPv4 or IPv6. It is also responsible for parsing EIGRP packets and informing DUAL of the new information received. EIGRP asks DUAL to make routing decisions, but the results are stored in the IPv4 or IPv6 routing table. Also, EIGRP is responsible for redistributing routes learned by other IPv4 or IPv6 routing protocols.

How to Implement EIGRP for IPv6

The tasks required to implement EIGRP for IPv6 are described in the following sections:

- [Enabling EIGRP for IPv6 on an Interface, page 166](#)
- [Configuring the Percentage of Link Bandwidth Used, page 168](#)
- [Configuring Summary Aggregate Addresses, page 169](#)
- [Configuring EIGRP Route Authentication, page 170](#)
- [Changing the Next Hop in EIGRP, page 172](#)
- [Adjusting the Interval Between Hello Packets in EIGRP for IPv6, page 173](#)
- [Adjusting the Hold Time in EIGRP for IPv6, page 174](#)
- [Disabling Split Horizon in EIGRP for IPv6, page 175](#)
- [Configuring EIGRP Stub Routing for Greater Stability, page 176](#)
- [Customizing an EIGRP for IPv6 Routing Process, page 178](#)
- [Monitoring and Maintaining EIGRP, page 181](#)

Enabling EIGRP for IPv6 on an Interface

Perform the following task to enable EIGRP for IPv6 on a specified interface. EIGRP for IPv6 is directly configured on the interfaces over which it runs, which allows EIGRP for IPv6 to be configured without the use of a global IPv6 address.

SUMMARY STEPS

1. **enable**
2. **configure terminal**
3. **ipv6 unicast-routing**
4. **interface** *type number*
5. **ipv6 enable**
6. **ipv6 eigrp** *as-number*
7. **no shutdown**

8. **ipv6 router eigrp** *as-number*
9. **router-id** {*ip-address* | *ipv6-address*}
10. **no shutdown**
11. **exit**
12. **show ipv6 eigrp interfaces** [*interface-type interface-number*] [*as-number*]

DETAILED STEPS

	Command or Action	Purpose
Step 1	enable Example: Router> enable	Enables privileged EXEC mode. • Enter your password if prompted.
Step 2	configure terminal Example: Router# configure terminal	Enters global configuration mode.
Step 3	ipv6 unicast-routing Example: Router(config)# ipv6 unicast-routing	Enables the forwarding of IPv6 unicast datagrams.
Step 4	interface <i>type number</i> Example: Router(config)# interface FastEthernet 0/0	Specifies the interface on which EIGRP is to be configured.
Step 5	ipv6 enable Example: Router(config-if)# ipv6 enable	Enables IPv6 processing on an interface that has not been configured with an explicit IPv6 address.
Step 6	ipv6 eigrp <i>as-number</i> Example: Router(config-if)# ipv6 eigrp 1	Enables EIGRP for IPv6 on a specified interface.
Step 7	no shutdown Example: Router(config-if) no shutdown	Allows the user to start the EIGRP for IPv6 protocol without changing any per-interface configuration.
Step 8	ipv6 router eigrp <i>as-number</i> Example: Router(config-if)# ipv6 router eigrp 1	Enters router configuration mode and creates an EIGRP for IPv6 routing process.

	Command or Action	Purpose
Step 9	router-id { <i>ip-address</i> <i>ipv6-address</i> } Example: Router(config-router)# router-id 10.1.1.1	Enables the use of a fixed router ID.
Step 10	no shutdown Example: Router(config-if) no shutdown	Allows the user to start the EIGRP for IPv6 protocol without changing any per-interface configuration.
Step 11	exit Example: Router(config-router) exit	Enter three times to return to privileged EXEC mode.
Step 12	show ipv6 eigrp interfaces [<i>interface-type</i> <i>interface-number</i>] [<i>as-number</i>] Example: Router# show ipv6 eigrp interfaces	Displays information about interfaces configured for EIGRP for IPv6.

Configuring the Percentage of Link Bandwidth Used

By default, EIGRP packets consume a maximum of 50 percent of the link bandwidth, as configured with the **bandwidth interface** configuration command. You might want to change that value if a different level of link utilization is required or if the configured bandwidth does not match the actual link bandwidth (it may have been configured to influence route metric calculations).

Perform the following task to configure the percentage of bandwidth that may be used by EIGRP on an interface.

SUMMARY STEPS

1. **enable**
2. **configure terminal**
3. **interface** *type number*
4. **bandwidth** {*kbps* | **inherit** [*kbps*]}
5. **ipv6 bandwidth-percent eigrp** *as-number percent*

DETAILED STEPS

	Command or Action	Purpose
Step 1	enable Example: Router> enable	Enables privileged EXEC mode. <ul style="list-style-type: none"> Enter your password if prompted.
Step 2	configure terminal Example: Router# configure terminal	Enters global configuration mode.
Step 3	interface <i>type number</i> Example: Router(config)# interface FastEthernet 0/0	Specifies the interface on which EIGRP is configured.
Step 4	bandwidth { <i>kbps</i> inherit [<i>kbps</i>]} Example: Router(config-if)# bandwidth 56	Sets and communicates the current bandwidth value for an interface to higher-level protocols.
Step 5	ipv6 bandwidth-percent eigrp <i>as-number percent</i> Example: Router(config-if)# ipv6 bandwidth-percent eigrp 1 75	Configures the percentage of bandwidth that may be used by EIGRP for IPv6 on an interface

Configuring Summary Aggregate Addresses

You can configure a summary aggregate address for a specified interface. If any more specific routes are in the routing table, EIGRP for IPv6 will advertise the summary address out the interface with a metric equal to the minimum of all more specific routes.

SUMMARY STEPS

- enable**
- configure terminal**
- interface** *type number*
- ipv6 summary-address eigrp** *as-number ipv6-address [admin-distance]*

DETAILED STEPS

	Command or Action	Purpose
Step 1	enable Example: Router> enable	Enables privileged EXEC mode. <ul style="list-style-type: none"> Enter your password if prompted.
Step 2	configure terminal Example: Router# configure terminal	Enters global configuration mode.
Step 3	interface <i>type number</i> Example: Router(config)# interface FastEthernet 0/0	Specifies the interface on which EIGRP is configured.
Step 4	ipv6 summary-address eigrp <i>as-number</i> <i>ipv6-address [admin-distance]</i> Example: Router(config-if)# ipv6 summary-address eigrp 1 2001:0DB8:0:1::/64	Configures a summary aggregate address for a specified interface.

Configuring EIGRP Route Authentication

EIGRP route authentication provides Message Digest 5 (MD5) authentication of routing updates from the EIGRP routing protocol. The MD5 keyed digest in each EIGRP packet prevents the introduction of unauthorized or false routing messages from unapproved sources.

Each key has its own key identifier, which is stored locally. The combination of the key identifier and the interface associated with the message uniquely identifies the authentication algorithm and MD5 authentication key in use.

You can configure multiple keys with lifetimes. Only one authentication packet is sent, regardless of how many valid keys exist. The software examines the key numbers in order from lowest to highest, and uses the first valid key it encounters. Note that the router needs to know the time.

Perform the following task to enable authentication of EIGRP routes:

SUMMARY STEPS

- enable**
- configure terminal**
- interface** *type number*
- ipv6 authentication mode eigrp** *as-number md5*
- ipv6 authentication key-chain eigrp** *as-number key-chain*
- exit**
- key chain** *name-of-chain*

8. **key** *key-id*
9. **key-string** *text*
10. **accept-lifetime** *start-time* {**infinite** | *end-time* | **duration** *seconds*}
11. **send-lifetime** *start-time* {**infinite** | *end-time* | **duration** *seconds*}

DETAILED STEPS

	Command or Action	Purpose
Step 1	enable Example: Router> enable	Enables privileged EXEC mode. <ul style="list-style-type: none">Enter your password if prompted.
Step 2	configure terminal Example: Router# configure terminal	Enters global configuration mode.
Step 3	interface <i>type number</i> Example: Router(config)# interface FastEthernet 0/0	Specifies the interface on which EIGRP is configured.
Step 4	ipv6 authentication mode eigrp <i>as-number</i> md5 Example: Router(config-if)# ipv6 authentication mode eigrp 1 md5	Specify the type of authentication used in EIGRP for IPv6 packets.
Step 5	ipv6 authentication key-chain eigrp <i>as-number</i> <i>key-chain</i> Example: Router(config-if)# ipv6 authentication key-chain eigrp 1 chain1	Enables authentication of EIGRP for IPv6 packets.
Step 6	exit Example: Router(config-if)# exit	Exits to global configuration mode.
Step 7	key chain <i>name-of-chain</i> Example: Router(config)# key chain chain1	Identifies a group of authentication keys. Use the name specified in Step 5.
Step 8	key <i>key-id</i> Example: Router(config-keychain)# key 1	Identifies an authentication key on a key chain.

	Command or Action	Purpose
Step 9	key-string <i>text</i> Example: Router(config-keychain-key)# key-string chain 1	Specifies the authentication string for a key.
Step 10	accept-lifetime <i>start-time</i> { infinite <i>end-time</i> duration <i>seconds</i> } Example: Router(config-keychain-key)# accept-lifetime 14:30:00 Jan 10 2006 duration 7200	Sets the time period during which the authentication key on a key chain is received as valid.
Step 11	send-lifetime <i>start-time</i> { infinite <i>end-time</i> duration <i>seconds</i> } Example: Router(config-keychain-key)# send-lifetime 15:00:00 Jan 10 2006 duration 3600	Sets the time period during which an authentication key on a key chain is valid to be sent.

Changing the Next Hop in EIGRP

EIGRP will, by default, set the IPv6 next-hop value to be itself for routes that it is advertising, even when advertising those routes back out the same interface where it learned them. To change this default, use the following task to instruct EIGRP to use the received next-hop value when advertising these routes.

SUMMARY STEPS

1. **enable**
2. **configure terminal**
3. **interface** *type number*
4. **no ipv6 next-hop-self eigrp** *as-number*

DETAILED STEPS

	Command or Action	Purpose
Step 1	enable Example: Router> enable	Enables privileged EXEC mode. <ul style="list-style-type: none"> • Enter your password if prompted.
Step 2	configure terminal Example: Router# configure terminal	Enters global configuration mode.

	Command or Action	Purpose
Step 3	interface <i>type number</i> Example: Router(config)# interface FastEthernet 0/0	Specifies the interface on which EIGRP is configured.
Step 4	no ipv6 next-hop-self eigrp <i>as-number</i> Example: Router(config-if)# no ipv6 next-hop-self eigrp 1	Changes the default IPv6 next-hop value and instructs EIGRP to use the received next-hop value.

Adjusting the Interval Between Hello Packets in EIGRP for IPv6

Routing devices periodically send hello packets to each other to dynamically learn of other routers on their directly attached networks. This information is used to discover neighbors and to learn when neighbors become unreachable or inoperative.

By default, hello packets are sent every 5 seconds. The exception is on low-speed, nonbroadcast multiaccess (NBMA) media, where the default hello interval is 60 seconds. Low speed is considered to be a rate of T1 or slower, as specified with the **bandwidth interface** command. The default hello interval remains 5 seconds for high-speed NBMA networks. Note that for the purposes of EIGRP, Frame Relay and Switched Multimegabit Data Service (SMDS) networks may or may not be considered to be NBMA. These networks are considered NBMA if the interface has not been configured to use physical multicasting; otherwise they are not considered NBMA.

You can configure the hold time on a specified interface for a particular EIGRP routing process designated by the autonomous system number. The hold time is advertised in hello packets and indicates to neighbors the length of time they should consider the sender valid. The default hold time is three times the hello interval, or 15 seconds. For slow-speed NBMA networks, the default hold time is 180 seconds.

Perform the following task to adjust the interval between hello packets.

SUMMARY STEPS

1. **enable**
2. **configure terminal**
3. **interface** *type number*
4. **ipv6 hello-interval eigrp** *as-number seconds*

DETAILED STEPS

	Command or Action	Purpose
Step 1	enable Example: Router> enable	Enables privileged EXEC mode. <ul style="list-style-type: none"> Enter your password if prompted.
Step 2	configure terminal Example: Router# configure terminal	Enters global configuration mode.
Step 3	interface <i>type number</i> Example: Router(config)# interface FastEthernet 0/0	Specifies the interface on which EIGRP is configured.
Step 4	ipv6 hello-interval eigrp <i>as-number seconds</i> Example: Router(config)# ipv6 hello-interval eigrp 1 10	Configures the hello interval for the EIGRP for IPv6 routing process designated by an autonomous system number.

Adjusting the Hold Time in EIGRP for IPv6

On very congested and large networks, the default hold time might not be sufficient time for all routers to receive hello packets from their neighbors. In this case, you may want to increase the hold time. Perform the following task to adjust the hold time.

SUMMARY STEPS

- enable**
- configure terminal**
- interface** *type number*
- ipv6 hold-time eigrp** *as-number seconds*

DETAILED STEPS

	Command or Action	Purpose
Step 1	enable Example: Router> enable	Enables privileged EXEC mode. <ul style="list-style-type: none"> Enter your password if prompted.
Step 2	configure terminal Example: Router# configure terminal	Enters global configuration mode.

	Command or Action	Purpose
Step 3	interface <i>type number</i> Example: Router(config)# interface FastEthernet 0/0	Specifies the interface on which EIGRP is configured.
Step 4	ipv6 hold-time eigrp <i>as-number seconds</i> Example: Router(config)# ipv6 hold-time eigrp 1 40	Configures the hold time for a particular EIGRP for IPv6 routing process designated by the autonomous system number.

Disabling Split Horizon in EIGRP for IPv6

Split horizon controls the sending of EIGRP update and query packets. When split horizon is enabled on an interface, update and query packets are not sent for destinations for which this interface is the next hop. Controlling update and query packets in this manner reduces the possibility of routing loops.

By default, split horizon is enabled on all interfaces.

Split horizon blocks route information from being advertised by a router out of any interface from which that information originated. This behavior usually optimizes communications among multiple routing devices, particularly when links are broken. However, with nonbroadcast networks (such as Frame Relay and SMDS), situations can arise for which this behavior is less than ideal. For these situations, including networks in which you have EIGRP configured, you may want to disable split horizon.

Perform the following task to disable split horizon.

SUMMARY STEPS

1. **enable**
2. **configure terminal**
3. **interface** *type number*
4. **no ipv6 split-horizon eigrp** *as-number*

DETAILED STEPS

	Command or Action	Purpose
Step 1	enable Example: Router> enable	Enables privileged EXEC mode. <ul style="list-style-type: none"> • Enter your password if prompted.
Step 2	configure terminal Example: Router# configure terminal	Enters global configuration mode.

	Command or Action	Purpose
Step 3	<code>interface type number</code> Example: Router(config)# interface FastEthernet 0/0	Specifies the interface on which EIGRP is configured.
Step 4	<code>no ipv6 split-horizon eigrp as-number</code> Example: Router(config-if)# no ipv6 split-horizon eigrp 101	Disables EIGRP for IPv6 split horizon on the specified interface.

Configuring EIGRP Stub Routing for Greater Stability

The EIGRP stub routing feature can help to provide greater network stability. In the event of network instability, this feature prevents EIGRP queries from being sent over limited bandwidth links to nontransit routers. Instead, distribution routers to which the stub router is connected answer the query on behalf of the stub router. This feature greatly reduces the chance of further network instability due to congested or problematic WAN links. The EIGRP stub routing feature also simplifies the configuration and maintenance of hub-and-spoke networks. When stub routing is enabled in dual-homed remote configurations, it is no longer necessary to configure filtering on remote routers to prevent those remote routers from appearing as transit paths to the hub routers.



Caution

EIGRP stub routing should be used only on stub routers. A stub router is defined as a router connected to the network core or distribution layer through which core transit traffic should not flow. A stub router should not have any EIGRP neighbors other than distribution routers. Ignoring this restriction will cause undesirable behavior.

To configure EIGRP stub routing, perform the following tasks:

- [Configuring a Router for EIGRP Stub Routing, page 176](#)
- [Verifying EIGRP Stub Routing, page 177](#)

Configuring a Router for EIGRP Stub Routing

Perform the following task to configure a remote or spoke router for EIGRP stub routing:

SUMMARY STEPS

1. `enable`
2. `configure terminal`
3. `interface type number`
4. `ipv6 router eigrp as-number`
5. `stub [receive-only | connected | static | summary | redistributed]`

DETAILED STEPS

	Command or Action	Purpose
Step 1	enable Example: Router> enable	Enables privileged EXEC mode. <ul style="list-style-type: none"> Enter your password if prompted.
Step 2	configure terminal Example: Router# configure terminal	Enters global configuration mode.
Step 3	interface <i>type number</i> Example: Router(config)# interface FastEthernet 0/0	Specifies the interface on which EIGRP is configured.
Step 4	ipv6 router eigrp <i>as-number</i> Example: Router(config-if)# ipv6 router eigrp 1	Specifies the EIGRP for IPv6 routing process to be configured.
Step 5	stub [receive-only connected static summary redistributed] Example: Router(config-router)# stub	Configures a router as a stub using EIGRP.

Verifying EIGRP Stub Routing

Perform the following task to verify that a remote router has been configured as a stub router with EIGRP.

SUMMARY STEPS

- enable
- show ipv6 eigrp neighbors [*interface-type* | *as-number* | **static** | **detail**]

DETAILED STEPS

	Command or Action	Purpose
Step 1	enable Example: Router> enable	Enables privileged EXEC mode. <ul style="list-style-type: none"> • Enter your password if prompted.
Step 2	show ipv6 eigrp neighbors [<i>interface-type</i> <i>as-number</i> static detail] Example: Router# show ipv6 eigrp neighbors detail	Displays the neighbors discovered by EIGRP for IPv6.

Customizing an EIGRP for IPv6 Routing Process

After you have enabled EIGRP for IPv6 on a specific interface, you can configure an EIGRP for IPv6 routing process. The following optional tasks provide information on how to configure an EIGRP for IPv6 routing process to suit your needs:

- [Logging EIGRP Neighbor Adjacency Changes, page 178](#)
- [Configuring Intervals Between Neighbor Warnings, page 179](#)
- [Adjusting the EIGRP for IPv6 Metric Weights, page 180](#)

Logging EIGRP Neighbor Adjacency Changes

You can enable the logging of neighbor adjacency changes to monitor the stability of the routing system and to help you detect problems. By default, adjacency changes are not logged. Use the following task to enable such logging:

SUMMARY STEPS

1. **enable**
2. **configure terminal**
3. **interface** *type number*
4. **ipv6 router eigrp** *as-number*
5. **log-neighbor-changes**

DETAILED STEPS

	Command or Action	Purpose
Step 1	enable Example: Router> enable	Enables privileged EXEC mode. <ul style="list-style-type: none"> Enter your password if prompted.
Step 2	configure terminal Example: Router# configure terminal	Enters global configuration mode.
Step 3	interface <i>type number</i> Example: Router(config)# interface FastEthernet 0/0	Enters the interface on which EIGRP is configured.
Step 4	ipv6 router eigrp <i>as-number</i> Example: Router(config-if)# ipv6 router eigrp 1	Specifies the EIGRP for IPv6 routing process to be configured.
Step 5	log-neighbor-changes Example: Router(config-router)# log-neighbor-changes	Enables the logging of changes in EIGRP for IPv6 neighbor adjacencies.

Configuring Intervals Between Neighbor Warnings

When neighbor warning messages occur, they are logged by default. Use the following task to configure the interval between neighbor warning messages.

SUMMARY STEPS

- enable**
- configure terminal**
- interface** *type number*
- ipv6 router eigrp** *as-number*
- log-neighbor-warnings** [*seconds*]

DETAILED STEPS

	Command or Action	Purpose
Step 1	<code>enable</code> Example: Router> enable	Enables privileged EXEC mode. <ul style="list-style-type: none"> Enter your password if prompted.
Step 2	<code>configure terminal</code> Example: Router# configure terminal	Enters global configuration mode.
Step 3	<code>interface type number</code> Example: Router(config)# interface FastEthernet 0/0	Enters the interface on which EIGRP is configured.
Step 4	<code>ipv6 router eigrp as-number</code> Example: Router(config-if)# ipv6 router eigrp 1	Specifies the EIGRP for IPv6 routing process to be configured.
Step 5	<code>log-neighbor-warnings [seconds]</code> Example: Router(config-router)# log-neighbor-warnings 300	Configures the logging intervals of EIGRP neighbor warning messages.

Adjusting the EIGRP for IPv6 Metric Weights

EIGRP for IPv6 uses the minimum bandwidth on the path to a destination network and the total delay to compute routing metrics. You can use the **metric weights** command to adjust the default behavior of EIGRP for IPv6 EIGRP for IPv6 routing and metric computations. For example, this adjustment allows you to tune system behavior to allow for satellite transmission. EIGRP for IPv6 metric defaults have been carefully selected to provide optimal performance in most networks.



Note

Adjusting EIGRP metric weights can dramatically affect network performance. Because of the complexity of this task, we recommend that you do not change the default values without guidance from an experienced network designer.

By default, the EIGRP composite metric is a 32-bit quantity that is a sum of the segment delays and the lowest segment bandwidth (scaled and inverted) for a given route. For a network of homogeneous media, this metric reduces to a hop count. For a network of mixed media (FDDI, Ethernet, and serial lines running from 9600 bits per second to T1 rates), the route with the lowest metric reflects the most desirable path to a destination.

Perform the following task to adjust the EIGRP for IPv6 metric weights:

SUMMARY STEPS

1. **enable**
2. **configure terminal**
3. **interface** *type number*
4. **ipv6 router eigrp** *as-number*
5. **metric weights** *tos k1 k2 k3 k4 k5*

DETAILED STEPS

	Command or Action	Purpose
Step 1	enable Example: Router> enable	Enables privileged EXEC mode. <ul style="list-style-type: none">• Enter your password if prompted.
Step 2	configure terminal Example: Router# configure terminal	Enters global configuration mode.
Step 3	interface <i>type number</i> Example: Router(config)# interface FastEthernet 0/0	Enters the interface on which EIGRP is configured.
Step 4	ipv6 router eigrp <i>as-number</i> Example: Router(config-if)# ipv6 router eigrp 1	Specifies the EIGRP for IPv6 routing process to be configured.
Step 5	metric weights <i>tos k1 k2 k3 k4 k5</i> Example: Router(config-router)# metric weights 0 2 0 2 0 0	Tunes EIGRP metric calculations.

Monitoring and Maintaining EIGRP

Use of **clear** and **debug** commands helps users monitor and maintain their EIGRP for IPv6 environments. The following tasks provide commands used to monitor and maintain EIGRP for IPv6:

- [Deleting Entries from EIGRP for IPv6 Routing Tables, page 181](#)
- [Using Debugging Commands to Troubleshoot an EIGRP for IPv6 Environment, page 182](#)

Deleting Entries from EIGRP for IPv6 Routing Tables

Perform the following task to delete entries from EIGRP for IPv6 routing tables.

SUMMARY STEPS

1. **enable**
2. **clear ipv6 eigrp** [*as-number*] [**neighbor** [*ipv6-address* | *interface-type interface-number*]]

DETAILED STEPS

	Command or Action	Purpose
Step 1	enable Example: Router> enable	Enables privileged EXEC mode. <ul style="list-style-type: none"> • Enter your password if prompted.
Step 2	clear ipv6 eigrp [<i>as-number</i>] [neighbor [<i>ipv6-address</i> <i>interface-type interface-number</i>]] Example: Router# clear ipv6 eigrp neighbor 3FEE:12E1:2AC1:EA32	Deletes entries from EIGRP for IPv6 routing tables.

Using Debugging Commands to Troubleshoot an EIGRP for IPv6 Environment

The use of **debug** commands can provide information users need to help troubleshoot an EIGRP for IPv6 environment. This task shows the commands used to display debugging information in EIGRP for IPv6. Note that the **debug** commands shown do not have to be used in any particular order and may be used only as needed:

SUMMARY STEPS

1. **enable**
2. **debug eigrp fsm**
3. **debug eigrp neighbor** [*siatimer*] [*static*]
4. **debug eigrp packet**
5. **debug eigrp transmit** [*ack*] [*build*] [*detail*] [*link*] [*packetize*] [*peerdown*] [*sia*] [*startup*] [*strange*]
6. **debug ipv6 eigrp** [*as-number*] [**neighbor** *ipv6-address* | **notification** | **summary**]

DETAILED STEPS

	Command or Action	Purpose
Step 1	<code>enable</code> Example: Router> enable	Enables privileged EXEC mode. <ul style="list-style-type: none"> Enter your password if prompted.
Step 2	<code>debug eigrp fsm</code> Example: Router# debug eigrp fsm	Displays debugging information about EIGRP feasible successor metrics (FSMs).
Step 3	<code>debug eigrp neighbor [sialtimer] [static]</code> Example: Router# debug eigrp neighbor	Displays neighbors discovered by EIGRP for IPv6.
Step 4	<code>debug eigrp packet</code> Example: Router# debug eigrp packet	Displays debugging information for EIGRP for IPv6 packets.
Step 5	<code>debug eigrp transmit [ack] [build] [detail] [link] [packetize] [peerdown] [sia] [startup] [strange]</code> Example: Router# debug eigrp transmit	Display transmittal messages sent by EIGRP for IPv6.
Step 6	<code>debug ipv6 eigrp [as-number] [neighbor ipv6-address notification summary]</code> Example: Router# debug ipv6 eigrp	Displays information about the EIGRP for IPv6 protocol.

Configuration Examples for Implementing EIGRP for IPv6

This section contains the following configuration example:

- [Configuring EIGRP to Establish Adjacencies on an Interface, page 183](#)

Configuring EIGRP to Establish Adjacencies on an Interface

EIGRP for IPv6 is configured directly on the interfaces over which it runs. This example shows the minimal configuration required for EIGRP for IPv6 to send hello packets in order to establish adjacencies on Ethernet 0:

```
ipv6 unicast-routing
interface e0
  ipv6 enable
  ipv6 eigrp 1
```

```

no shutdown
!
ipv6 router eigrp 1
  router-id 10.1.1.1
no shutdown

```

Where to Go Next

If you want to implement IPv6 interior gateway routing protocols, refer to the “Implementing RIP for IPv6” or “Implementing IS-IS for IPv6” module. To implement exterior gateway routing protocol Border Gateway Protocol (BGP), refer to the *Implementing Multiprotocol BGP for IPv6* module.

Additional References

The following sections provide references related to implementing EIGRP for IPv6.

Related Documents

Related Topic	Document Title
EIGRP for IPv6 commands	<i>Cisco IOS IPv6 Command Reference</i>
IPv6 supported feature list	<i>Start Here: Cisco IOS Software Release Specifics for IPv6 Features</i>
EIGRP for IPv4	“EIGRP,” <i>Cisco IOS IP Routing Protocols Configuration Guide, Release 12.4</i>
EIGRP for IPv4 commands	“EIGRP Commands,” <i>Cisco IOS IP Routing Protocols Command Reference, Release 12.4</i>

Standards

Standard	Title
No new or modified standards are supported by this feature, and support for existing standards has not been modified by this feature.	—

MIBs

MIB	MIBs Link
	To locate and download MIBs for selected platforms, Cisco IOS releases, and feature sets, use Cisco MIB Locator found at the following URL: http://www.cisco.com/go/mibs

RFCs

RFC	Title
No new or modified RFCs are supported by this feature, and support for existing RFCs has not been modified by this feature.	—

Technical Assistance

Description	Link
The Cisco Technical Support website contains thousands of pages of searchable technical content, including links to products, technologies, solutions, technical tips, and tools. Registered Cisco.com users can log in from this page to access even more content.	http://www.cisco.com/techsupport

Feature Information for Implementing EIGRP for IPv6

Table 14 lists the release history for this feature.

Not all commands may be available in your Cisco IOS software release. For release information about a specific command, see the command reference documentation.

Cisco IOS software images are specific to a Cisco IOS software release, a feature set, and a platform. Use Cisco Feature Navigator to find information about platform support and Cisco IOS software image support. Access Cisco Feature Navigator at <http://www.cisco.com/go/fn>. You must have an account on Cisco.com. If you do not have an account or have forgotten your username or password, click **Cancel** at the login dialog box and follow the instructions that appear.



Note

Table 14 lists only the Cisco IOS software release that introduced support for a given feature in a given Cisco IOS software release train. Unless noted otherwise, subsequent releases of that Cisco IOS software release train also support that feature.

Table 14 Feature Information for EIGRP for IPv6

Feature Name	Releases	Feature Information
EIGRP Support for IPv6	12.4(6)T	<p>Customers can configure EIGRP to route IPv6 prefixes. There is no linkage between EIGRP for IPv4 and EIGRP for IPv6; they are configured and managed separately. However, the configuration of EIGRP for IPv4 and IPv6 is similar and provides operational familiarity and continuity.</p> <p>The following sections provide information about this feature:</p> <ul style="list-style-type: none"> “Cisco EIGRP for IPv6 Implementation” section on page 164 “Enabling EIGRP for IPv6 on an Interface” section on page 166 <p>The following commands were introduced or modified by this feature: accept-lifetime, bandwidth (interface), clear ipv6 eigrp, debug eigrp fsm, debug eigrp neighbor, debug eigrp packet, debug eigrp transmit, debug ipv6 eigrp, default-metric (EIGRP), distance (IPv6 EIGRP), distribute-list prefix-list (IPv6 EIGRP), ipv6 authentication key-chain eigrp, ipv6 authentication mode eigrp, ipv6 bandwidth-percent eigrp, ipv6 eigrp, ipv6 hello-interval eigrp, ipv6 hold-time eigrp, ipv6 next-hop-self eigrp, ipv6 router eigrp, ipv6 split-horizon eigrp, ipv6 summary-address eigrp, key chain, key, key-string (authentication), log-neighbor-changes (IPv6 EIGRP), log-neighbor-warnings, maximum-paths (IPv6), metric weights (EIGRP), neighbor (EIGRP), passive-interface (IPv6), redistribute (IPv6), router-id (IPv6), send-lifetime, show ipv6 eigrp interfaces, show ipv6 eigrp neighbors, show ipv6 eigrp topology, show ipv6 eigrp traffic, stub, timers active-time, variance (EIGRP).</p>



Configuring GLBP for IPv6

Gateway Load Balancing Protocol (GLBP) is a First Hop Router Redundancy Protocol (FHRP) that protects data traffic from a failed router or circuit, like Hot Standby Router Protocol (HSRP) and Virtual Router Redundancy Protocol (VRRP), while allowing packet load sharing between a group of redundant routers.

Module History

This module was first published on February 27, 2006, and last updated on February 27, 2006.

Finding Feature Information in This Module

Your Cisco IOS software release may not support all features. To find information about feature support and configuration, use the [“Feature Information for GLBP for IPv6”](#) section on page 213.

Contents

- [Prerequisites for GLBP for IPv6, page 187](#)
- [Information About GLBP for IPv6, page 188](#)
- [How to Configure GLBP for IPv6, page 191](#)
- [Configuration Examples for GLBP for IPv6, page 208](#)
- [Additional References, page 210](#)
- [Glossary, page 212](#)
- [Feature Information for GLBP for IPv6, page 213](#)

Prerequisites for GLBP for IPv6

Before configuring GLBP, ensure that the routers can support multiple MAC addresses on the physical interfaces. For each GLBP forwarder to be configured, an additional MAC address is used.

In IPv6, link-local addressing must be disabled on interfaces configured with GLBP.

Information About GLBP for IPv6

To configure GLBP, you need to understand the following concepts:

- [GLBP Overview, page 188](#)
- [GLBP Active Virtual Gateway, page 188](#)
- [GLBP Virtual MAC Address Assignment, page 189](#)
- [GLBP Virtual Gateway Redundancy, page 190](#)
- [GLBP Virtual Forwarder Redundancy, page 190](#)
- [GLBP Gateway Priority, page 190](#)
- [GLBP Gateway Weighting and Tracking, page 191](#)
- [GLBP Benefits, page 191](#)

GLBP Overview

The Gateway Load Balancing Protocol feature provides automatic router backup for IP or IPv6 hosts configured with a single default gateway on an IEEE 802.3 LAN. Multiple first hop routers on the LAN combine to offer a single virtual first hop IP or IPv6 router while sharing the IP or IPv6 packet forwarding load. Other routers on the LAN may act as redundant GLBP routers that will become active if any of the existing forwarding routers fail.

GLBP performs a similar function for the user as HSRP and VRRP. HSRP and VRRP allow multiple routers to participate in a virtual router group configured with a virtual IP or IPv6 address. One member is elected to be the active router to forward packets sent to the virtual IP or IPv6 address for the group. The other routers in the group are redundant until the active router fails. These standby routers have unused bandwidth that the protocol is not using. Although multiple virtual router groups can be configured for the same set of routers, the hosts must be configured for different default gateways, which results in an extra administrative burden. The advantage of GLBP is that it additionally provides load balancing over multiple routers (gateways) using a single virtual IP or IPv6 address and multiple virtual MAC addresses. The forwarding load is shared among all routers in a GLBP group rather than being handled by a single router while the other routers stand idle. Each host is configured with the same virtual IP or IPv6 address, and all routers in the virtual router group participate in forwarding packets. GLBP members communicate between each other through hello messages sent every 3 seconds to the multicast address 224.0.0.102, User Datagram Protocol (UDP) port 3222 (source and destination).

GLBP Active Virtual Gateway

Members of a GLBP group elect one gateway to be the active virtual gateway (AVG) for that group. Other group members provide backup for the AVG in the event that the AVG becomes unavailable. The function of the AVG is that it assigns a virtual MAC address to each member of the GLBP group. Each gateway assumes responsibility for forwarding packets sent to the virtual MAC address assigned to it by the AVG. These gateways are known as active virtual forwarders (AVFs) for their virtual MAC address.

The AVG is also responsible for answering Address Resolution Protocol (ARP) requests for the virtual IP or IPv6 address. Load sharing is achieved by the AVG replying to the ARP requests with different virtual MAC addresses.

In [Figure 21](#), Router A is the AVG for a GLBP group, and is responsible for the virtual IP address 10.21.8.10. Router A is also an AVF for the virtual MAC address 0007.b400.0101. Router B is a member of the same GLBP group and is designated as the AVF for the virtual MAC address 0007.b400.0102. Client 1 has a default gateway IP address of 10.21.8.10 and a gateway MAC address of 0007.b400.0101. Client 2 shares the same default gateway IP address but receives the gateway MAC address 0007.b400.0102 because Router B is sharing the traffic load with Router A.

Figure 21 GLBP Topology

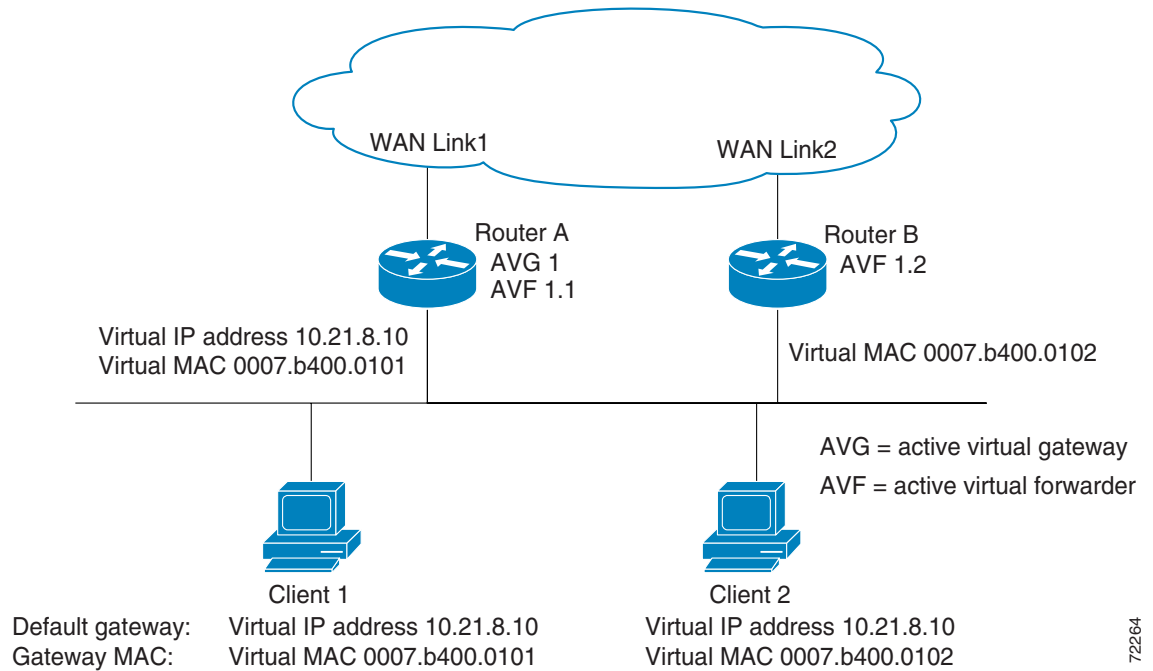

If Router A becomes unavailable, Client 1 will not lose access to the WAN because Router B will assume responsibility for forwarding packets sent to the virtual MAC address of Router A, and for responding to packets sent to its own virtual MAC address. Router B will also assume the role of the AVG for the entire GLBP group. Communication for the GLBP members continues despite the failure of a router in the GLBP group.

GLBP Virtual MAC Address Assignment

A GLBP group allows up to four virtual MAC addresses per group. The AVG is responsible for assigning the virtual MAC addresses to each member of the group. Other group members request a virtual MAC address after they discover the AVG through hello messages. Gateways are assigned the next MAC address in sequence. A virtual forwarder that is assigned a virtual MAC address by the AVG is known as a primary virtual forwarder. Other members of the GLBP group learn the virtual MAC addresses from hello messages. A virtual forwarder that has learned the virtual MAC address is referred to as a secondary virtual forwarder.

GLBP Virtual Gateway Redundancy

GLBP operates virtual gateway redundancy in the same way as HSRP. One gateway is elected as the AVG, another gateway is elected as the standby virtual gateway, and the remaining gateways are placed in a listen state.

If an AVG fails, the standby virtual gateway will assume responsibility for the virtual IP or IPv6 address. A new standby virtual gateway is then elected from the gateways in the listen state.

GLBP Virtual Forwarder Redundancy

GLBP virtual forwarder redundancy is similar to virtual gateway redundancy with an AVF. If the AVF fails, one of the secondary virtual forwarders in the listen state assumes responsibility for the virtual MAC address.

The new AVF is also a primary virtual forwarder for a different forwarder number. GLBP migrates hosts away from the old forwarder number using two timers that start as soon as the gateway changes to the active virtual forwarder state. GLBP uses the hello messages to communicate the current state of the timers.

The redirect time is the interval during which the AVG continues to redirect hosts to the old virtual forwarder MAC address. When the redirect time expires, the AVG stops using the old virtual forwarder MAC address in ARP replies, although the virtual forwarder will continue to forward packets that were sent to the old virtual forwarder MAC address.

The secondary hold time is the interval during which the virtual forwarder is valid. When the secondary hold time expires, the virtual forwarder is removed from all gateways in the GLBP group. The expired virtual forwarder number becomes eligible for reassignment by the AVG.

GLBP Gateway Priority

GLBP gateway priority determines the role that each GLBP gateway plays and the results if the AVG fails.

Priority also determines if a GLBP router functions as a backup virtual gateway and the order of ascendancy to becoming an AVG if the current AVG fails. You can configure the priority of each backup virtual gateway with a value of 1 through 255 using the **glbp priority** command.

In [Figure 21](#), if Router A—the AVG in a LAN topology—fails, an election process takes place to determine which backup virtual gateway should take over. In this example, Router B is the only other member in the group so it will automatically become the new AVG. If another router existed in the same GLBP group with a higher priority, then the router with the higher priority would be elected. If both routers have the same priority, the backup virtual gateway with the higher IP or IPv6 address would be elected to become the active virtual gateway.

By default, the GLBP virtual gateway preemptive scheme is disabled. A backup virtual gateway can become the AVG only if the current AVG fails, regardless of the priorities assigned to the virtual gateways. You can enable the GLBP virtual gateway preemptive scheme using the **glbp preempt** command. Preemption allows a backup virtual gateway to become the AVG, if the backup virtual gateway is assigned a higher priority than the current AVG.

GLBP Gateway Weighting and Tracking

GLBP uses a weighting scheme to determine the forwarding capacity of each router in the GLBP group. The weighting assigned to a router in the GLBP group can be used to determine whether it will forward packets and, if so, the proportion of hosts in the LAN for which it will forward packets. Thresholds can be set to disable forwarding when the weighting falls below a certain value. When the weighting rises above another threshold, forwarding is automatically reenabled.

The GLBP group weighting can be automatically adjusted by tracking the state of an interface within the router. If a tracked interface goes down, the GLBP group weighting is reduced by a specified value. Different interfaces can be tracked to decrement the GLBP weighting by varying amounts.

By default, the GLBP virtual forwarder preemptive scheme is enabled with a delay of 30 seconds. A backup virtual forwarder can become the AVF if the current AVF weighting falls below the low weighting threshold for 30 seconds. You can disable the GLBP forwarder preemptive scheme using the **no glbp forwarder preempt** command or change the delay using the **glbp forwarder preempt delay minimum** command.

GLBP Benefits

Load Sharing

You can configure GLBP in such a way that traffic from LAN clients can be shared equitably among multiple routers.

Multiple Virtual Routers

GLBP supports up to 1024 virtual routers (GLBP groups) on each physical interface of a router and up to four virtual forwarders per group.

Preemption

The redundancy scheme of GLBP enables you to preempt an active virtual gateway with a higher priority backup virtual gateway that has become available. Forwarder preemption works in a similar way, except that forwarder preemption uses weighting instead of priority and is enabled by default.

Authentication

You can also use the industry-standard Message Digest 5 (MD5) algorithm for improved reliability, security, and protection against GLBP-spoofing software. A router within a GLBP group with a different authentication string than other routers will be ignored by other group members. You can alternatively use a simple text password authentication scheme between GLBP group members to detect configuration errors.

How to Configure GLBP for IPv6

Customizing the behavior of GLBP is optional. Be aware that as soon as you enable a GLBP group, that group is operating. It is possible that if you first enable a GLBP group before customizing GLBP, the router could take over control of the group and become the AVG before you have finished customizing the feature. Therefore, if you plan to customize GLBP, it is a good idea to do so before enabling GLBP.

This section contains the following procedures:

- [Customizing GLBP, page 192](#) (optional)

- [Configuring GLBP Authentication, page 194](#) (optional)
- [Configuring GLBP Weighting Values and Object Tracking, page 202](#) (optional)
- [Enabling and Verifying GLBP, page 204](#) (required)
- [Troubleshooting the Gateway Load Balancing Protocol, page 206](#) (optional)

Customizing GLBP

This task explains how to customize your GLBP configuration.

SUMMARY STEPS

1. **enable**
2. **configure terminal**
3. **interface** *type number*
4. **ip address** *ip-address mask [secondary]*
or
ipv6 address { *ipv6-address/prefix-length | prefix-name ipv6-prefix/prefix-length | autoconfig [default-route]* }
5. **glbp group timers** [*msec*] *hellotime [msec] holdtime*
6. **glbp group timers redirect** *redirect timeout*
7. **glbp group load-balancing** [*host-dependent | round-robin | weighted*]
8. **glbp group priority** *level*
9. **glbp group preempt** [*delay minimum seconds*]
10. **glbp group name** *redundancy-name*
11. **exit**

DETAILED STEPS

	Command or Action	Purpose
Step 1	enable Example: Router> enable	Enables privileged EXEC mode. <ul style="list-style-type: none">• Enter your password if prompted.
Step 2	configure terminal Example: Router# configure terminal	Enters global configuration mode.
Step 3	interface <i>type number</i> Example: Router(config)# interface fastethernet 0/0	Specifies an interface type and number, and enters interface configuration mode.

	Command or Action	Purpose
Step 4	<p>ip address <i>ip-address mask</i> [secondary]</p> <p>or</p> <p>ipv6 address {<i>ipv6-address/prefix-length</i> <i>prefix-name ipv6-prefix/prefix-length</i> autoconfig [<i>default-route</i>]}</p> <p>Example: Router(config-if)# ip address 10.21.8.32 255.255.255.0</p> <p>or</p> <p>Example: Router(config-if)# ipv6 address 2001:0DB8:0:7272::72/64</p>	<p>Specifies a primary or secondary IP address for an interface.</p> <p>or</p> <p>Configures an IPv6 address based on an IPv6 general prefix and enables IPv6 processing on an interface.</p>
Step 5	<p>glbp group timers [msec] <i>hellotime</i> [msec] <i>holdtime</i></p> <p>Example: Router(config-if)# glbp 10 timers 5 18</p>	<p>Configures the interval between successive hello packets sent by the AVG in a GLBP group.</p> <ul style="list-style-type: none"> The <i>holdtime</i> argument specifies the interval in seconds before the virtual gateway and virtual forwarder information in the hello packet is considered invalid. The optional msec keyword specifies that the following argument will be expressed in milliseconds, instead of the default seconds.
Step 6	<p>glbp group timers redirect <i>redirect timeout</i></p> <p>Example: Router(config-if)# glbp 10 timers redirect 600 7200</p>	<p>Configures the time interval during which the AVG continues to redirect clients to an AVF.</p> <ul style="list-style-type: none"> The <i>timeout</i> argument specifies the interval in seconds before a secondary virtual forwarder becomes invalid.
Step 7	<p>glbp group load-balancing [host-dependent round-robin weighted]</p> <p>Example: Router(config-if)# glbp 10 load-balancing host-dependent</p>	<p>Specifies the method of load balancing used by the GLBP AVG.</p>
Step 8	<p>glbp group priority <i>level</i></p> <p>Example: Router(config-if)# glbp 10 priority 254</p>	<p>Sets the priority level of the gateway within a GLBP group.</p> <ul style="list-style-type: none"> The default value is 100.
Step 9	<p>glbp group preempt [delay minimum <i>seconds</i>]</p> <p>Example: Router(config-if)# glbp 10 preempt delay minimum 60</p>	<p>Configures the router to take over as AVG for a GLBP group if it has a higher priority than the current AVG.</p> <ul style="list-style-type: none"> This command is disabled by default. Use the optional delay and minimum keywords and the <i>seconds</i> argument to specify a minimum delay interval in seconds before preemption of the AVG takes place.

Command or Action	Purpose
<p>Step 10 <code>glbp group name redundancy-name</code></p> <p>Example: Router(config-if)# glbp 10 name abcompany</p>	<p>Enables IP or IPv6 redundancy by assigning a name to the GLBP group.</p> <ul style="list-style-type: none"> The GLBP redundancy client must be configured with the same GLBP group name so the redundancy client and the GLBP group can be connected. <p> Note This command is for future use. The GLBP redundancy client is not yet available.</p>
<p>Step 11 <code>exit</code></p> <p>Example: Router(config-if)# exit</p>	<p>Exits interface configuration mode, and returns the router to global configuration mode.</p>

Configuring GLBP Authentication

The following sections describe configuration tasks for GLBP authentication. The task you perform depends on whether you want to use text authentication, a simple MD5 key string, or MD5 key chains for authentication.

- [Configuring GLBP MD5 Authentication Using a Key String, page 195](#)
- [Configuring GLBP MD5 Authentication Using a Key Chain, page 197](#)
- [Configuring GLBP Text Authentication, page 200](#)

How GLBP MD5 Authentication Works

GLBP MD5 authentication provides greater security than the alternative plain text authentication scheme. MD5 authentication allows each GLBP group member to use a secret key to generate a keyed MD5 hash that is part of the outgoing packet. A keyed hash of an incoming packet is generated and, if the hash within the incoming packet does not match the generated hash, the packet is ignored.

The key for the MD5 hash can either be given directly in the configuration using a key string or supplied indirectly through a key chain.

A router will ignore incoming GLBP packets from routers that do not have the same authentication configuration for a GLBP group. GLBP has three authentication schemes:

- No authentication
- Plain text authentication
- MD5 authentication

GLBP packets will be rejected in any of the following cases:

- The authentication schemes differ on the router and in the incoming packet.
- MD5 digests differ on the router and in the incoming packet.
- Text authentication strings differ on the router and in the incoming packet.

Configuring GLBP MD5 Authentication Using a Key String

Configuring GLBP MD5 authentication protects the router against spoofing software and uses the industry-standard MD5 algorithm for improved reliability and security. Perform this task to configure GLBP MD5 authentication using a key string.

SUMMARY STEPS

1. **enable**
2. **configure terminal**
3. **interface** *type number*
4. **ip address** *ip-address mask* [**secondary**]
or
ipv6 address { *ipv6-address/prefix-length* | *prefix-name ipv6-prefix/prefix-length* | **autoconfig** [*default-route*] }
5. **glbp group-number authentication md5 key-string** [0 | 7] *key*
6. **glbp group-number ip** [*ip-address* [**secondary**]]
or
glbp group ipv6 [*ipv6-address* | **autoconfig**]
7. Repeat Steps 1 through 6 on each router that will communicate.
8. **end**
9. **show glbp**

DETAILED STEPS

	Command	Purpose
Step 1	enable Example: Router> enable	Enables privileged EXEC mode. <ul style="list-style-type: none"> • Enter your password if prompted.
Step 2	configure terminal Example: Router# configure terminal	Enters global configuration mode.
Step 3	interface <i>type number</i> Example: Router(config)# interface Ethernet 0/1	Configures an interface type and enters interface configuration mode.

Command	Purpose
<p>Step 4 <code>ip address ip-address mask [secondary]</code></p> <p>or</p> <p><code>ipv6 address {ipv6-address/prefix-length prefix-name ipv6-prefix/prefix-length autoconfig [default-route]}</code></p> <p>Example: Router(config-if)# ip address 10.21.8.32 255.255.255.0</p> <p>or</p> <p>Example: Router(config-if)# ipv6 address 2001:0DB8:0:7272::72/64</p>	<p>Specifies a primary or secondary IP address for an interface.</p> <p>or</p> <p>Configures an IPv6 address based on an IPv6 general prefix and enables IPv6 processing on an interface.</p>
<p>Step 5 <code>glbp group-number authentication md5 key-string [0 7] key</code></p> <p>Example: Router(config-if)# glbp 1 authentication md5 key-string d00b4r987654321a</p>	<p>Configures an authentication key for GLBP MD5 authentication.</p> <ul style="list-style-type: none"> • The number of characters in the command plus the key string must not exceed 255 characters. • No keyword before the <i>key</i> argument or specifying 0 means the key is unencrypted. • Specifying 7 means the key is encrypted. The key-string authentication key will automatically be encrypted if the service password-encryption global configuration command is enabled.
<p>Step 6 <code>glbp group-number ip [ip-address [secondary]]</code></p> <p>or</p> <p><code>glbp group ipv6 [ipv6-address autoconfig]</code></p> <p>Example: Router(config-if)# glbp 1 ip 10.21.0.12</p> <p>or</p> <p>Example: Router(config-if)# glbp 1 ipv6 2001:0DB8:0:7272::72/64</p>	<p>Enables GLBP on an interface and identifies the primary IP address of the virtual gateway.</p> <p>or</p> <p>Enables GLBP in IPv6.</p>
<p>Step 7 Repeat Steps 1 through 6 on each router that will communicate.</p>	<p>—</p>

	Command	Purpose
Step 8	<code>end</code>	Returns to privileged EXEC mode.
	Example: <code>Router(config-if)# end</code>	
Step 9	<code>show glbp</code>	(Optional) Displays GLBP information. <ul style="list-style-type: none"> Use this command to verify your configuration. The key string and authentication type will be displayed if configured.
	Example: <code>Router# show glbp</code>	

Configuring GLBP MD5 Authentication Using a Key Chain

Perform this task to configure GLBP MD5 authentication using a key chain. Key chains allow a different key string to be used at different times according to the key chain configuration. GLBP will query the appropriate key chain to obtain the current live key and key ID for the specified key chain.

SUMMARY STEPS

- `enable`
- `configure terminal`
- `key chain name-of-chain`
- `key key-id`
- `key-string string`
- `exit`
- `exit`
- `interface type number`
- `ip address ip-address mask [secondary]`
or
`ipv6 address {ipv6-address/prefix-length | prefix-name ipv6-prefix/prefix-length | autoconfig [default-route]}`
- `glbp group-number authentication md5 key-chain name-of-chain`
- `glbp group-number ip [ip-address [secondary]]`
or
`glbp group ipv6 [ipv6-address | autoconfig]`
- Repeat Steps 1 through 11 on each router that will communicate.
- `end`
- `show glbp`
- `show key chain`

DETAILED STEPS

	Command	Purpose
Step 1	enable Example: Router> enable	Enables privileged EXEC mode. <ul style="list-style-type: none"> Enter your password if prompted.
Step 2	configure terminal Example: Router# configure terminal	Enters global configuration mode.
Step 3	key chain <i>name-of-chain</i> Example: Router(config)# key chain glbp2	Enables authentication for routing protocols and identifies a group of authentication keys.
Step 4	key <i>key-id</i> Example: Router(config-keychain)# key 100	Identifies an authentication key on a key chain. <ul style="list-style-type: none"> The <i>key-id</i> must be a number.
Step 5	key-string <i>string</i> Example: Router(config-keychain-key)# key-string xmen382	Specifies the authentication string for a key. <ul style="list-style-type: none"> The <i>string</i> can be 1 to 80 uppercase or lowercase alphanumeric characters; the first character cannot be a numeral.
Step 6	exit Example: Router(config-keychain-key)# exit	Returns to keychain configuration mode.
Step 7	exit Example: Router(config-keychain)# exit	Returns to global configuration mode.
Step 8	interface <i>type number</i> Example: Router(config)# interface Ethernet 0/1	Configures an interface type and enters interface configuration mode.

	Command	Purpose
Step 9	<p>ip address <i>ip-address mask [secondary]</i></p> <p>or</p> <p>ipv6 address {<i>ipv6-address/prefix-length prefix-name</i> <i>ipv6-prefix/prefix-length autoconfig</i> <i>[default-route]</i>}</p> <p>Example: Router(config-if)# ip address 10.21.8.32 255.255.255.0</p> <p>or</p> <p>Example: Router(config-if)# ipv6 address 2001:0DB8:0:7272::72/64</p>	<p>Specifies a primary or secondary IP address for an interface.</p> <p>or</p> <p>Configures an IPv6 address based on an IPv6 general prefix and enables IPv6 processing on an interface.</p>
Step 10	<p>glbp group-number authentication md5 key-chain <i>name-of-chain</i></p> <p>Example: Router(config-if)# glbp 1 authentication md5 key-chain glbp2</p>	<p>Configures an authentication MD5 key chain for GLBP MD5 authentication.</p> <ul style="list-style-type: none"> The key chain name must match the name specified in Step 3.
Step 11	<p>glbp group-number ip [<i>ip-address [secondary]</i>]</p> <p>or</p> <p>glbp group ipv6 [<i>ipv6-address autoconfig</i>]</p> <p>Example: Router(config-if)# glbp 1 ip 10.21.0.12</p> <p>or</p> <p>Example: Router(config-if)# glbp 1 ipv6 2001:0DB8:0:7272::72/64</p>	<p>Enables GLBP on an interface and identifies the primary IP address of the virtual gateway.</p> <p>or</p> <p>Enables GLBP in IPv6.</p>
Step 12	Repeat Steps 1 through 11 on each router that will communicate.	—
Step 13	<p>end</p> <p>Example: Router(config-if)# end</p>	Returns to privileged EXEC mode.

	Command	Purpose
Step 14	show glbp Example: Router# show glbp	(Optional) Displays GLBP information. <ul style="list-style-type: none"> Use this command to verify your configuration. The key chain and authentication type will be displayed if configured.
Step 15	show key chain Example: Router# show key chain	(Optional) Displays authentication key information.

Configuring GLBP Text Authentication

Perform this task to configure GLBP text authentication. This method of authentication provides minimal security. Use MD5 authentication if security is required.

SUMMARY STEPS

- enable**
- configure terminal**
- interface** *type number*
- ip address** *ip-address mask [secondary]*
or
ipv6 address {*ipv6-address/prefix-length* | *prefix-name ipv6-prefix/prefix-length* | **autoconfig** [*default-route*]}
- glbp** *group-number authentication text string*
- glbp** *group-number ip [ip-address [secondary]]*
or
glbp *group ipv6 [ipv6-address | autoconfig]*
- Repeat Steps 1 through 6 on each router that will communicate.
- end**
- show glbp**

DETAILED STEPS

	Command	Purpose
Step 1	<p>enable</p> <p>Example: Router> enable</p>	<p>Enables privileged EXEC mode.</p> <ul style="list-style-type: none"> Enter your password if prompted.
Step 2	<p>configure terminal</p> <p>Example: Router# configure terminal</p>	<p>Enters global configuration mode.</p>
Step 3	<p>interface <i>type number</i></p> <p>Example: Router(config)# interface Ethernet 0/1</p>	<p>Configures an interface type and enters interface configuration mode.</p>
Step 4	<p>ip address <i>ip-address mask [secondary]</i></p> <p>or</p> <p>ipv6 address {<i>ipv6-address/prefix-length</i> <i>prefix-name</i> <i>ipv6-prefix/prefix-length</i> autoconfig [<i>default-route</i>]}</p> <p>Example: Router(config-if)# ip address 10.21.8.32 255.255.255.0</p> <p>or</p> <p>Example: Router(config-if)# ipv6 address 2001:0DB8:0:7272::72/64</p>	<p>Specifies a primary or secondary IP address for an interface.</p> <p>or</p> <p>Configures an IPv6 address based on an IPv6 general prefix and enables IPv6 processing on an interface.</p>
Step 5	<p>glbp <i>group-number authentication text string</i></p> <p>Example: Router(config-if)# glbp 10 authentication text stringxyz</p>	<p>Authenticates GLBP packets received from other routers in the group.</p> <ul style="list-style-type: none"> If you configure authentication, all routers within the GLBP group must use the same authentication string.
Step 6	<p>glbp <i>group-number ip [ip-address [secondary]]</i></p> <p>or</p> <p>glbp <i>group ipv6 [ipv6-address autoconfig]</i></p> <p>Example: Router(config-if)# glbp 1 ip 10.21.0.12</p> <p>or</p> <p>Example: Router(config-if)# glbp 1 ipv6 2001:0DB8:0:7272::72/64</p>	<p>Enables GLBP on an interface and identifies the primary IP address of the virtual gateway.</p> <p>or</p> <p>Activates GLBP in IPv6.</p>

	Command	Purpose
Step 7	Repeat Steps 1 through 6 on each router that will communicate.	—
Step 8	<code>end</code> Example: <code>Router(config-if)# end</code>	Returns to privileged EXEC mode.
Step 9	<code>show glbp</code> Example: <code>Router# show glbp</code>	(Optional) Displays GLBP information. <ul style="list-style-type: none"> Use this command to verify your configuration.

Configuring GLBP Weighting Values and Object Tracking

Perform this task to configure GLBP weighting values and object tracking.

GLBP weighting is used to determine whether a router can act as a virtual forwarder. Initial weighting values can be set and optional thresholds specified. Interface states can be tracked and a decrement value set to reduce the weighting value if the interface goes down. When the GLBP router weighting drops below a specified value, the router will no longer be an active virtual forwarder. When the weighting rises above a specified value, the router can resume its role as an active virtual forwarder.

SUMMARY STEPS

- `enable`
- `configure terminal`
- `track object-number interface type number {line-protocol | ip routing}`
- `exit`
- `interface type number`
- `glbp group weighting maximum [lower lower] [upper upper]`
- `glbp group weighting track object-number [decrement value]`
- `glbp group forwarder preempt [delay minimum seconds]`
- `end`
- `show track [object-number | brief] [interface [brief] | ip route [brief] | resolution | timers]`

DETAILED STEPS

	Command or Action	Purpose
Step 1	<p>enable</p> <p>Example: Router> enable</p>	<p>Enables privileged EXEC mode.</p> <ul style="list-style-type: none"> Enter your password if prompted.
Step 2	<p>configure terminal</p> <p>Example: Router# configure terminal</p>	<p>Enters global configuration mode.</p>
Step 3	<p>track object-number interface type number {line-protocol ip routing}</p> <p>Example: Router(config)# track 2 interface POS 6/0 ip routing</p>	<p>Configures an interface to be tracked where changes in the state of the interface affect the weighting of a GLBP gateway, and enters tracking configuration mode.</p> <ul style="list-style-type: none"> This command configures the interface and corresponding object number to be used with the glbp weighting track command. The line-protocol keyword tracks whether the interface is up. The ip routing keywords also check that IP or IPv6 routing is enabled on the interface, and an IP or IPv6 address is configured.
Step 4	<p>exit</p> <p>Example: Router(config-track)# exit</p>	<p>Returns to global configuration mode.</p>
Step 5	<p>interface type number</p> <p>Example: Router(config)# interface fastethernet 0/0</p>	<p>Enters interface configuration mode.</p>
Step 6	<p>glbp group weighting maximum [lower lower] [upper upper]</p> <p>Example: Router(config-if)# glbp 10 weighting 110 lower 95 upper 105</p>	<p>Specifies the initial weighting value, and the upper and lower thresholds, for a GLBP gateway.</p>
Step 7	<p>glbp group weighting track object-number [decrement value]</p> <p>Example: Router(config-if)# glbp 10 weighting track 2 decrement 5</p>	<p>Specifies an object to be tracked that affects the weighting of a GLBP gateway.</p> <ul style="list-style-type: none"> The <i>value</i> argument specifies a reduction in the weighting of a GLBP gateway when a tracked object fails.

	Command or Action	Purpose
Step 8	<p>glbp group forwarder preempt [delay minimum <i>seconds</i>]</p> <p>Example: Router(config-if)# glbp 10 forwarder preempt delay minimum 60</p>	<p>Configures the router to take over as the AVF for a GLBP group if the current AVF for a GLBP group falls below its low weighting threshold.</p> <ul style="list-style-type: none"> This command is enabled by default with a delay of 30 seconds. Use the optional delay and minimum keywords and the <i>seconds</i> argument to specify a minimum delay interval in seconds before preemption of the AVF takes place.
Step 9	<p>end</p> <p>Example: Router(config-if)# exit</p>	<p>Returns to privileged EXEC mode.</p>
Step 10	<p>show track [<i>object-number</i> brief] [interface [<i>brief</i>] ip route [<i>brief</i>] resolution timers]</p> <p>Example: Router# show track 2</p>	<p>Displays tracking information.</p>

Enabling and Verifying GLBP

This task explains how to enable GLBP on an interface and verify its configuration and operation. GLBP is designed to be easy to configure. Each gateway in a GLBP group must be configured with the same group number, and at least one gateway in the GLBP group must be configured with the virtual IP or IPv6 address to be used by the group. All other required parameters can be learned.

Prerequisites

If VLANs are in use on an interface, the GLBP group number must be different for each VLAN.

SUMMARY STEPS

- enable**
- configure terminal**
- interface** *type number*
- ip address** *ip-address mask* [**secondary**]
or
ipv6 address {*ipv6-address/prefix-length* | *prefix-name ipv6-prefix/prefix-length* | **autoconfig** [*default-route*]}
- glbp group ip** [*ip-address* [**secondary**]]
or
glbp group ipv6 [*ipv6-address* | **autoconfig**]
- exit**

7. show glbp [interface-type interface-number] [group] [state] [brief]

DETAILED STEPS

	Command or Action	Purpose
Step 1	<p>enable</p> <p>Example: Router> enable</p>	<p>Enables privileged EXEC mode.</p> <ul style="list-style-type: none"> Enter your password if prompted.
Step 2	<p>configure terminal</p> <p>Example: Router# configure terminal</p>	<p>Enters global configuration mode.</p>
Step 3	<p>interface <i>type number</i></p> <p>Example: Router(config)# interface fastethernet 0/0</p>	<p>Specifies an interface type and number, and enters interface configuration mode.</p>
Step 4	<p>ip address <i>ip-address mask [secondary]</i></p> <p>or</p> <p>ipv6 address {<i>ipv6-address/prefix-length</i> <i>prefix-name ipv6-prefix/prefix-length</i> autoconfig [<i>default-route</i>]}</p> <p>Example: Router(config-if)# ip address 10.21.8.32 255.255.255.0</p> <p>or</p> <p>Example: Router(config-if)# ipv6 address 2001:0DB8:0:7272::72/64</p>	<p>Specifies a primary or secondary IP address for an interface.</p> <p>or</p> <p>Configures an IPv6 address based on an IPv6 general prefix and enables IPv6 processing on an interface.</p>
Step 5	<p>glbp <i>group-number ip [ip-address [secondary]]</i></p> <p>or</p> <p>glbp <i>group ipv6 [ipv6-address autoconfig]</i></p> <p>Example: Router(config-if)# glbp 1 ip 10.21.0.12</p> <p>or</p> <p>Example: Router(config-if)# glbp 1 ipv6 2001:0DB8:0:7272::72/64</p>	<p>Enables GLBP on an interface and identifies the primary IP address of the virtual gateway.</p> <p>or</p> <p>Enables GLBP in IPv6.</p>

	Command or Action	Purpose
Step 6	exit Example: Router(config-if)# exit	Exits interface configuration mode, and returns the router to global configuration mode.
Step 7	show glbp [<i>interface-type interface-number</i>] [<i>group</i>] [<i>state</i>] [brief] Example: Router(config)# show glbp 10	(Optional) Displays information about GLBP groups on a router. <ul style="list-style-type: none"> Use the optional brief keyword to display a single line of information about each virtual gateway or virtual forwarder. See the display output for this command in the “Examples” section of this task.

Examples

In the following example, output information is displayed about the status of the GLBP group, named 10, on the router:

```
Router# show glbp 10

FastEthernet0/0 - Group 10
  State is Active
    2 state changes, last state change 23:50:33
  Virtual IP address is 10.21.8.10
  Hello time 5 sec, hold time 18 sec
    Next hello sent in 4.300 secs
  Redirect time 600 sec, forwarder time-out 7200 sec
  Authentication text "stringabc"
  Preemption enabled, min delay 60 sec
  Active is local
  Standby is unknown
  Priority 254 (configured)
  Weighting 105 (configured 110), thresholds: lower 95, upper 105
    Track object 2 state Down decrement 5
  Load balancing: host-dependent
  There is 1 forwarder (1 active)
  Forwarder 1
    State is Active
      1 state change, last state change 23:50:15
    MAC address is 0007.b400.0101 (default)
    Owner ID is 0005.0050.6c08
    Redirection enabled
    Preemption enabled, min delay 60 sec
    Active is local, weighting 105
```

Troubleshooting the Gateway Load Balancing Protocol

The Gateway Load Balancing Protocol feature introduces five privileged EXEC mode commands to enable diagnostic output concerning various events relating to the operation of GLBP to be displayed on a console. The **debug condition glbp**, **debug glbp errors**, **debug glbp events**, **debug glbp packets**, and **debug glbp terse** commands are intended only for troubleshooting purposes because the volume of output generated by the software can result in severe performance degradation on the router. Perform this task to minimize the impact of using the **debug glbp** commands.

This procedure will minimize the load on the router created by the **debug condition glbp** or **debug glbp** command because the console port will no longer generate character-by-character processor interrupts. If you cannot connect to a console directly, you can run this procedure via a terminal server. If you must break the Telnet connection, however, you may not be able to reconnect because the router may be unable to respond due to the processor load of generating the debugging output.

Prerequisites

This task requires a router running GLBP to be attached directly to a console.

SUMMARY STEPS

1. **enable**
2. **configure terminal**
3. **no logging console**
4. Use Telnet to access a router port and repeat Steps 1 and 2.
5. **end**
6. **terminal monitor**
7. **debug condition glbp** *interface-type interface-number group* [*forwarder*]
8. **terminal no monitor**

DETAILED STEPS

	Command or Action	Purpose
Step 1	enable Example: Router> enable	Enables privileged EXEC mode. <ul style="list-style-type: none"> • Enter your password if prompted.
Step 2	configure terminal Example: Router# configure terminal	Enters global configuration mode.
Step 3	no logging console Example: Router(config)# no logging console	Disables all logging to the console terminal. <ul style="list-style-type: none"> • To reenabling logging to the console, use the logging console command in global configuration mode.
Step 4	Use Telnet to access a router port and repeat Steps 1 and 2.	Enters global configuration mode in a recursive Telnet session, which allows the output to be redirected away from the console port.
Step 5	end Example: Router(config)# end	Exits to privileged EXEC mode.

	Command or Action	Purpose
Step 6	<code>terminal monitor</code>	Enables logging output on the virtual terminal.
Step 7	<p>Example: Router# terminal monitor</p> <p><code>debug condition glbp interface-type interface-number group [forwarder]</code></p> <p>Example: Router# debug condition glbp fastethernet 0/0 10 1</p>	<p>Displays debugging messages about GLBP conditions.</p> <ul style="list-style-type: none"> Try to enter only specific debug condition glbp or debug glbp commands to isolate the output to a certain subcomponent and minimize the load on the processor. Use appropriate arguments and keywords to generate more detailed debug information on specified subcomponents. Enter the specific no debug condition glbp or no debug glbp command when you are finished.
Step 8	<p><code>terminal no monitor</code></p> <p>Example: Router# terminal no monitor</p>	Disables logging on the virtual terminal.

Configuration Examples for GLBP for IPv6

This section contains the following configuration examples:

- [Customizing GLBP Configuration: Example, page 208](#)
- [GLBP MD5 Authentication Using Key Strings: Example, page 208](#)
- [GLBP MD5 Authentication Using Key Chains: Example, page 209](#)
- [GLBP Text Authentication: Example, page 209](#)
- [GLBP Weighting: Example, page 209](#)
- [Enabling GLBP Configuration: Example, page 209](#)

Customizing GLBP Configuration: Example

In the following example, Router A, shown in Figure 1, is configured with a number of GLBP commands:

```
interface fastethernet 0/0
ip address 10.21.8.32 255.255.255.0
glbp 10 timers 5 18
glbp 10 timers redirect 600 7200
glbp 10 load-balancing host-dependent
glbp 10 priority 254
glbp 10 preempt delay minimum 60
```

GLBP MD5 Authentication Using Key Strings: Example

The following example configures GLBP MD5 authentication using a key string:

```

!
interface Ethernet 0/1
 ip address 10.0.0.1 255.255.255.0
 glbp 2 authentication md5 key-string ThisStringIsTheSecretKey
 glbp 2 ip 10.0.0.10

```

GLBP MD5 Authentication Using Key Chains: Example

In the following example, GLBP queries the key chain “AuthenticateGLBP” to obtain the current live key and key ID for the specified key chain:

```

key chain AuthenticateGLBP
 key 1
  key-string ThisIsASecretKey
interface Ethernet 0/1
 ip address 10.0.0.1 255.255.255.0
 glbp 2 authentication md5 key-chain AuthenticateGLBP
 glbp 2 ip 10.0.0.10

```

GLBP Text Authentication: Example

The following example configures GLBP text authentication using a text string:

```

interface fastethernet 0/0
 ip address 10.21.8.32 255.255.255.0
 glbp 10 authentication text stringxyz
 glbp 10 ip 10.21.8.10

```

GLBP Weighting: Example

In the following example, Router A, shown in Figure 1, is configured to track the IP routing state of the POS interfaces 5/0 and 6/0, an initial GLBP weighting with upper and lower thresholds is set, and a weighting decrement value of 10 is set. If POS interfaces 5/0 and 6/0 go down, the weighting value of the router is reduced.

```

track 1 interface POS 5/0 ip routing
track 2 interface POS 6/0 ip routing
interface fastethernet 0/0
 glpb 10 weighting 110 lower 95 upper 105
 glbp 10 weighting track 1 decrement 10
 glbp 10 weighting track 2 decrement 10
 glbp 10 forwarder preempt delay minimum 60

```

Enabling GLBP Configuration: Example

In the following example, Router A, shown in Figure 1, is configured to enable GLBP, and the virtual IP address of 10.21.8.10 is specified for GLBP group 10:

```

interface fastethernet 0/0
 ip address 10.21.8.32 255.255.255.0
 glbp 10 ip 10.21.8.10

```

Additional References

The following sections provide references related to configuring GLBP for IPv6.

Related Documents

Related Topic	Document Title
GLBP commands: complete command syntax, command mode, command history, defaults, usage guidelines, and examples	<i>Cisco IOS IP Application Services Command Reference</i> , Release 12.4
Key chains and key management commands: complete command syntax, command mode, command history, defaults, usage guidelines, and examples	<i>Cisco IOS IP Routing Command Reference</i> , Release 12.4
IPv6 commands: complete command syntax, command mode, command history, defaults, usage guidelines, and examples	<i>Cisco IOS IPv6 Command Reference</i> , Release 12.4
Object Tracking	“Configuring Enhanced Object Tracking” configuration module
VRRP	“Configuring VRRP” configuration module
HSRP	“Configuring HSRP” configuration module

Standards

Standards	Title
No new or modified standards are supported by this feature, and support for existing standards has not been modified by this feature.	—

MIBs

MIBs	MIBs Link
No new MIBs are supported by this feature, and support for existing MIBs has not been modified by this feature.	To locate and download MIBs for selected platforms, Cisco IOS releases, and feature sets, use Cisco MIB Locator found at the following URL: http://www.cisco.com/go/mibs

RFCs

RFCs	Title
No new or modified RFCs are supported by this feature, and support for existing RFCs has not been modified by this feature.	—

Technical Assistance

Description	Link
The Cisco Technical Support website contains thousands of pages of searchable technical content, including links to products, technologies, solutions, technical tips, and tools. Registered Cisco.com users can log in from this page to access even more content.	http://www.cisco.com/techsupport

Glossary

AVF—active virtual forwarder. One virtual forwarder within a GLBP group is elected as active virtual forwarder for a specified virtual MAC address, and is responsible for forwarding packets sent to that MAC address. Multiple active virtual forwarders can exist for each GLBP group.

AVG—active virtual gateway. One virtual gateway within a GLBP group is elected as the active virtual gateway, and is responsible for the operation of the protocol.

GLBP gateway—Gateway Load Balancing Protocol gateway. A router or gateway running GLBP. Each GLBP gateway may participate in one or more GLBP groups.

GLBP group—Gateway Load Balancing Protocol group. One or more GLBP gateways configured with the same GLBP group number on connected Ethernet interfaces.

vIP—virtual IP address. An IPv4 address. There must be only one virtual IP address for each configured GLBP group. The virtual IP address must be configured on at least one GLBP group member. Other GLBP group members can learn the virtual IP address from hello messages.

**Note**

Refer to the [Internetworking Terms and Acronyms](#) for terms not included in this glossary.

Feature Information for GLBP for IPv6

Table 15 lists the features in this module and provides links to specific configuration information. Only features that were introduced or modified in Cisco IOS Release 12.2(1) or Cisco IOS Releases 12.2(14)S or a later release appear in the table.

Not all commands may be available in your Cisco IOS software release. For details on when support for a specific command was introduced, see the command reference documentation.

Cisco IOS software images are specific to a Cisco IOS software release, a feature set, and a platform. Use Cisco Feature Navigator to find information about platform support and Cisco IOS software image support. Access Cisco Feature Navigator at <http://www.cisco.com/go/fn>. You must have an account on Cisco.com. If you do not have an account or have forgotten your username or password, click **Cancel** at the login dialog box and follow the instructions that appear.

Table 15 Feature Information

Feature Name	Releases	Feature Configuration Information
Gateway Load Balancing Protocol	12.2(14)S 12.2(15)T	GLBP protects data traffic from a failed router or circuit, like HSRP and VRRP, while allowing packet load sharing between a group of redundant routers. All sections in this configuration module provide information about this feature.
GLBP MD5 Authentication	12.2(18)S 12.3(2)T	MD5 authentication provides greater security than the alternative plain text authentication scheme. MD5 authentication allows each GLBP group member to use a secret key to generate a keyed MD5 hash that is part of the outgoing packet. A keyed hash of an incoming packet is generated and, if the hash within the incoming packet does not match the generated hash, the packet is ignored. The following section provides information about this feature: <ul style="list-style-type: none"> • Configuring GLBP Authentication, page 194 The following commands were modified by this feature: glbp authentication and show glbp .
FHRP—GLBP Support for IPv6	12.4(6)T	Support for IPv6 was added. All sections in this configuration module provide information about this feature. The following command was added by this feature: glbp ipv6 . The following command was modified by this feature: show glbp .



Implementing IPsec in IPv6 Security

Cisco IOS IPv6 security features for your Cisco networking devices can protect your network against degradation or failure and also against data loss or compromise resulting from intentional attacks and from unintended but damaging mistakes by well-meaning network users.

Cisco IOS IPsec functionality provides network data encryption at the IP packet level, offering a robust, standards-based security solution. IPsec provides data authentication and anti-replay services in addition to data confidentiality services.

IPsec is a mandatory component of IPv6 specification. OSPF for IPv6 provides IPsec authentication support and protection, and IPv6 IPsec tunnel mode and encapsulation is used to protect IPv6 unicast and multicast traffic.

Finding Support Information for Platforms and Cisco IOS Software Images

Use Cisco Feature Navigator to find information about platform support and Cisco IOS software image support. Access Cisco Feature Navigator at <http://www.cisco.com/go/fn>. You must have an account on Cisco.com. If you do not have an account or have forgotten your username or password, click **Cancel** at the login dialog box and follow the instructions that appear.

Contents

- [Prerequisites for Implementing IPsec for IPv6 Security, page 215](#)
- [Information About Implementing IPsec for IPv6 Security, page 216](#)
- [How to Implement IPsec for IPv6 Security, page 218](#)
- [Configuration Examples for IPsec for IPv6 Security, page 232](#)
- [Additional References, page 233](#)

Prerequisites for Implementing IPsec for IPv6 Security

- You should be familiar with IPv4. Refer to the publications referenced in the “[Related Documents](#)” section for IPv4 configuration and command reference information.
- You should be familiar with IPv6 addressing and basic configuration. Refer to the *Implementing Basic Connectivity for IPv6* module for more information.

Table 16 identifies the earliest release for each early-deployment train in which the feature became available.

Table 16 Minimum Required Cisco IOS Release

Feature	Minimum Required Cisco IOS Release by Release Train
IPv6 IPsec to Authenticate Open Shortest Path First for IPv6 (OSPFv3)	12.3(4)T, 12.4, 12.4(2)T
IPv6 IPsec VPN	12.4(4)T

Information About Implementing IPsec for IPv6 Security

To implement security features for IPv6, you need to understand the following concepts:

- [OSPF for IPv6 Authentication Support with IPsec, page 216](#)
- [IPsec for IPv6, page 216](#)

OSPF for IPv6 Authentication Support with IPsec

In order to ensure that OSPF for IPv6 packets are not altered and re-sent to the router, causing the router to behave in a way not desired by its managers, OSPF for IPv6 packets must be authenticated. OSPF for IPv6 uses the IP Security (IPsec) secure socket application program interface (API) to add authentication to OSPF for IPv6 packets. This API has been extended to provide support for IPv6.

OSPF for IPv6 requires the use of IPsec to enable authentication. Crypto images are required to use authentication, because only crypto images include the IPsec API needed for use with OSPF for IPv6.

In OSPF for IPv6, authentication fields have been removed from OSPF headers. When OSPF runs on IPv6, OSPF relies on the IPv6 authentication header (AH) and IPv6 encapsulating security payload (ESP) to ensure integrity, authentication, and confidentiality of routing exchanges. IPv6 AH and ESP extension headers can be used to provide authentication and confidentiality to OSPF for IPv6.

To configure IPsec, users configure a security policy, which is a combination of the security policy index (SPI) and the key (the key creates and validates the Message Digest 5 [MD5] value). IPsec for OSPF for IPv6 can be configured on an interface or on an OSPF area. For higher security, users should configure a different policy on each interface configured with IPsec. If a user configures IPsec for an OSPF area, the policy is applied to all of the interfaces in that area, except for the interfaces that have IPsec configured directly. Once IPsec is configured for OSPF for IPv6, IPsec is invisible to the user.

For information about configuring IPsec on OSPF in IPv6, see the *Implementing OSPF for IPv6* module.

IPsec for IPv6

IP Security, or IPsec, is a framework of open standards developed by the Internet Engineering Task Force (IETF) that provide security for transmission of sensitive information over unprotected networks such as the Internet. IPsec acts at the network layer, protecting and authenticating IP packets between participating IPsec devices (peers), such as Cisco routers. IPsec provides the following optional network security services. In general, local security policy will dictate the use of one or more of these services:

- Data confidentiality—The IPsec sender can encrypt packets before sending them across a network.

- Data integrity—The IPsec receiver can authenticate packets sent by the IPsec sender to ensure that the data has not been altered during transmission.
- Data origin authentication—The IPsec receiver can authenticate the source of the IPsec packets sent. This service depends upon the data integrity service.
- Antireplay—The IPsec receiver can detect and reject replayed packets.

With IPsec, data can be sent across a public network without observation, modification, or spoofing. IPsec functionality is similar in both IPv6 and IPv4; however, site-to-site tunnel mode only is supported in IPv6.

In IPv6, IPsec is implemented using the AH authentication header and the ESP extension header. The authentication header provides integrity and authentication of the source. It also provides optional protection against replayed packets. The authentication header protects the integrity of most of the IP header fields and authenticates the source through a signature-based algorithm. The ESP header provides confidentiality, authentication of the source, connectionless integrity of the inner packet, antireplay, and limited traffic flow confidentiality.

The Internet Key Exchange (IKE) protocol is a key management protocol standard that is used in conjunction with IPsec. IPsec can be configured without IKE, but IKE enhances IPsec by providing additional features, flexibility, and ease of configuration for the IPsec standard.

IKE is a hybrid protocol that implements the Oakley key exchange and Skeme key exchange inside the Internet Security Association Key Management Protocol (ISAKMP) framework. (ISAKMP, Oakley, and Skeme are security protocols implemented by IKE.) (see [Figure 22](#)). This functionality is similar to the security gateway model using IPv4 IPsec protection.

IPv6 IPsec Site-to-Site Protection Using Virtual Tunnel Interface

The IPsec virtual tunnel interface (VTI) provides site-to-site IPv6 crypto protection of IPv6 traffic. Native IPv6 IPsec encapsulation is used to protect all types of IPv6 unicast and multicast traffic.

The IPsec VTI allows IPv6 routers to work as security gateways, establish IPsec tunnels between other security gateway routers, and provide crypto IPsec protection for traffic from internal networks when it is sent across the public IPv6 Internet (see [Figure 22](#)). This functionality is similar to the security gateway model using IPv4 IPsec protection.

Figure 22 IPsec Tunnel Interface for IPv6

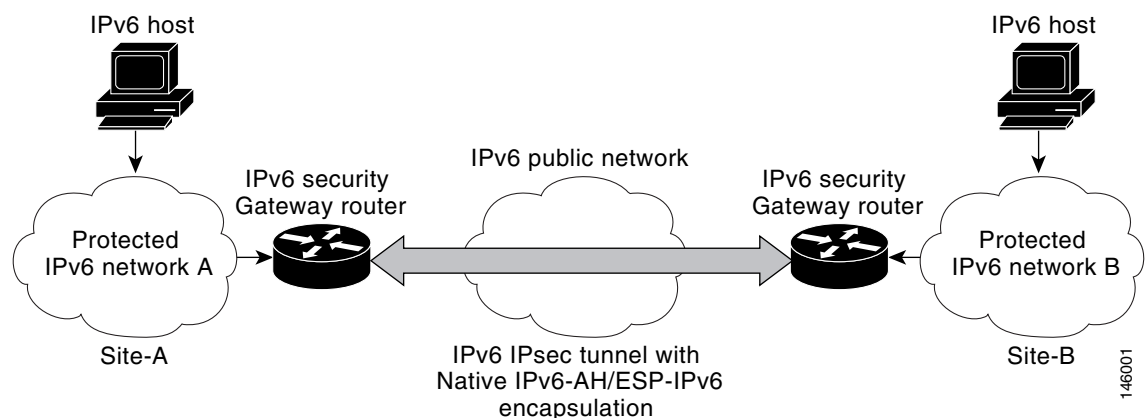

146001

When the IPsec tunnel is configured, IKE and IPsec security associations (SAs) are negotiated and set up before the line protocol for the tunnel interface is changed to the UP state. The remote IKE peer is the same as the tunnel destination address; the local IKE peer will be the address picked from tunnel source interface which has the same IPv6 address scope as tunnel destination address.

Figure 2 shows the IPsec packet format.

Figure 23 IPv6 IPsec Packet Format

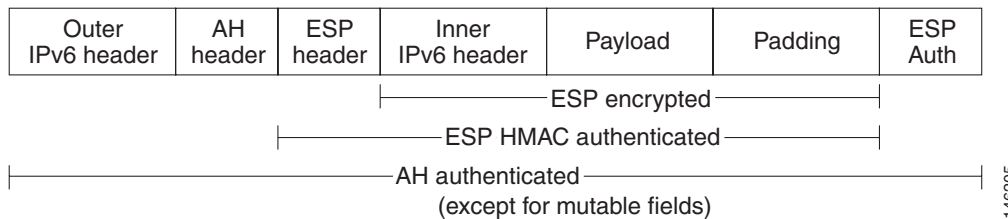

For further information on IPsec VTI, see the *IPsec Virtual Tunnel Interface* module in Cisco IOS Release 12.3(14)T.

How to Implement IPsec for IPv6 Security

The tasks in the following sections explain how to configure IPsec for IPv6:

- [Configuring a VTI for Site-to-Site IPv6 IPsec Protection, page 218](#)
- [Verifying IPsec Tunnel Mode Configuration, page 226](#)
- [Troubleshooting IPsec for IPv6 Configuration and Operation, page 228](#)

Configuring a VTI for Site-to-Site IPv6 IPsec Protection

The following tasks describe how to configure an IPsec VTI for site-to-site IPsec protection of IPv6 unicast and multicast traffic. This feature allows the use of IPv6 IPsec encapsulation to protect IPv6 traffic.

- [Creating an IKE Policy and a Preshared Key in IPv6, page 218](#) (Required)
- [Configuring ISAKMP Aggressive Mode, page 221](#) (Optional)
- [Configuring an IPsec Transform Set and IPsec Profile, page 222](#) (Required)
- [Configuring an ISAKMP Profile in IPv6, page 223](#) (Required)
- [Configuring IPv6 IPsec VTI, page 224](#) (Required)

Creating an IKE Policy and a Preshared Key in IPv6

Because IKE negotiations must be protected, each IKE negotiation begins by agreement of both peers on a common (shared) IKE policy. This policy states which security parameters will be used to protect subsequent IKE negotiations and mandates how the peers are authenticated.

After the two peers agree upon a policy, the security parameters of the policy are identified by an SA established at each peer, and these SAs apply to all subsequent IKE traffic during the negotiation.

You can configure multiple, prioritized policies on each peer—each with a different combination of parameter values. However, at least one of these policies must contain exactly the same encryption, hash, authentication, and Diffie-Hellman parameter values as one of the policies on the remote peer. For each policy that you create, you assign a unique priority (1 through 10,000, with 1 being the highest priority).

**Note**

If you are interoperating with a device that supports only one of the values for a parameter, your choice is limited to the value supported by the other device. Aside from this limitation, there is often a trade-off between security and performance, and many of these parameter values represent such a trade-off. You should evaluate the level of security risks for your network and your tolerance for these risks.

IKE Peers Agreeing Upon a Matching IKE Policy

When the IKE negotiation begins, IKE searches for an IKE policy that is the same on both peers. The peer that initiates the negotiation will send all its policies to the remote peer, and the remote peer will try to find a match. The remote peer looks for a match by comparing its own highest priority policy against the policies received from the other peer. The remote peer checks each of its policies in order of its priority (highest priority first) until a match is found.

A match is made when both policies from the two peers contain the same encryption, hash, authentication, and Diffie-Hellman parameter values, and when the remote peer's policy specifies a lifetime that is less than or equal to the lifetime in the policy being compared. (If the lifetimes are not identical, the shorter lifetime—from the remote peer's policy—will be used.)

If a match is found, IKE will complete negotiation, and IPsec security associations will be created. If no acceptable match is found, IKE refuses negotiation and IPsec will not be established.

**Note**

Depending on which authentication method is specified in a policy, additional configuration might be required. If a peer's policy does not have the required companion configuration, the peer will not submit the policy when attempting to find a matching policy with the remote peer.

ISAKMP Identity for Preshared Keys

You should set the ISAKMP identity for each peer that uses preshared keys in an IKE policy.

When two peers use IKE to establish IPsec SAs, each peer sends its identity to the remote peer. Each peer sends either its hostname or its IPv6 address, depending on how you have set the ISAKMP identity of the router.

By default, a peer's ISAKMP identity is the IPv6 address of the peer. If appropriate, you could change the identity to be the peer's hostname instead. As a general rule, set the identities of all peers the same way—either all peers should use their IPv6 addresses or all peers should use their hostnames. If some peers use their hostnames and some peers use their IPv6 addresses to identify themselves to each other, IKE negotiations could fail if the identity of a remote peer is not recognized and a DNS lookup is unable to resolve the identity.

SUMMARY STEPS

1. **enable**
2. **configure terminal**
3. **crypto isakmp policy *priority***
4. **authentication {rsa-sig | rsa-encr | pre-share}**

5. **hash** {sha | md5}
6. **group** {1 | 2 | 5}
7. **encryption** {des | 3des | aes | aes 192 | aes 256}
8. **lifetime** *seconds*
9. **exit**
10. **crypto isakmp key** *password-type keystring* {**address** *peer-address* [*mask*] | **ipv6** {*ipv6-address/ipv6-prefix*} | **hostname** *hostname*} [**no-xauth**]
11. **crypto keyring** *keyring-name* [**vrf** *fvrif-name*]
12. **pre-shared-key** {**address** *address* [*mask*] | **hostname** *hostname* | **ipv6** {*ipv6-address* | *ipv6-prefix*}}
key *key*

DETAILED STEPS

	Command or Action	Purpose
Step 1	enable Example: Router> enable	Enables privileged EXEC mode. <ul style="list-style-type: none"> Enter your password if prompted.
Step 2	configure terminal Example: Router# configure terminal	Enters global configuration mode.
Step 3	crypto isakmp policy <i>priority</i> Example: Router(config)# crypto isakmp policy 15	Defines an IKE policy, and enters ISAKMP policy configuration mode. Policy number 1 indicates the policy with the highest priority. The smaller the <i>priority</i> argument value, the higher the priority.
Step 4	authentication { rsa-sig rsa-encr pre-share } Example: Router(config-isakmp-policy)# authentication pre-share	Specifies the authentication method within an IKE policy. The rsa-sig and rsa-encr keywords are not supported in IPv6.
Step 5	hash { sha md5 } Example: Router(config-isakmp-policy)# hash md5	Specifies the hash algorithm within an IKE policy.
Step 6	group { 1 2 5 } Example: Router(config-isakmp-policy)# group 2	Specifies the Diffie-Hellman group identifier within an IKE policy.
Step 7	encryption { des 3des aes aes 192 aes 256 } Example: Router(config-isakmp-policy)# encryption 3des	Specifies the encryption algorithm within an IKE policy.

	Command or Action	Purpose
Step 8	lifetime <i>seconds</i> Example: Router(config-isakmp-policy)# lifetime 43200	Specifies the lifetime of an IKE SA. Setting the IKE lifetime value is optional.
Step 9	exit Example: Router(config-isakmp-policy)# exit	Enter this command to exit ISAKMP policy configuration mode and enter global configuration mode.
Step 10	crypto isakmp key <i>enc-type-digit keystring</i> {address peer-address [mask] ipv6 {ipv6-address/ipv6-prefix} hostname hostname) [no-xauth] Example: Router(config)# crypto isakmp key 0 my-preshare-key-0 address ipv6 3ffe:1001::2/128	Configures a preshared authentication key.
Step 11	crypto keyring <i>keyring-name [vrf fvrf-name]</i> Example: Router(config)# crypto keyring keyring1	Defines a crypto keyring to be used during IKE authentication.
Step 12	pre-shared-key {address address [mask] hostname hostname ipv6 {ipv6-address ipv6-prefix}} key key Example: Router (config-keyring)# pre-shared-key ipv6 3FFE:2002::A8BB:CCFF:FE01:2C02/128	Defines a preshared key to be used for IKE authentication.

Configuring ISAKMP Aggressive Mode

This optional task describes how to configure ISAKMP aggressive mode.



Note

You likely do not need to configure aggressive mode in a site-to-site scenario. The default mode is typically used.

SUMMARY STEPS

1. **enable**
2. **configure terminal**
3. **crypto isakmp peer** **{address {ipv4-address | ipv6 ipv6-address ipv6-prefix-length} | hostname fqdn-hostname}**
4. **set aggressive-mode client-endpoint** **{client-endpoint | ipv6 ipv6-address}**

DETAILED STEPS

	Command or Action	Purpose
Step 1	enable Example: Router> enable	Enables privileged EXEC mode. <ul style="list-style-type: none">• Enter your password if prompted.
Step 2	configure terminal Example: Router# configure terminal	Enters global configuration mode.
Step 3	crypto isakmp peer { address { <i>ipv4-address</i> ipv6 <i>ipv6-address ipv6-prefix-length</i> } hostname <i>fqdn-hostname</i> } Example: Router(config)# crypto isakmp peer address ipv6 3FFE:2002::A8BB:CCFF:FE01:2C02/128	Enables an IPsec peer for IKE querying for tunnel attributes.
Step 4	set aggressive-mode client-endpoint { <i>client-endpoint</i> ipv6 <i>ipv6-address</i> } Example: Router(config-isakmp-peer)# set aggressive mode client-endpoint ipv6 3FFE:2002::A8BB:CCFF:FE01:2C02/128	Defines the remote peer's IPv6 address, which will be used by aggressive mode negotiation. The remote peer's address is usually the client side's end-point address.

Configuring an IPsec Transform Set and IPsec Profile

This task describes how to configure an IPsec transform set. A transform set is a combination of security protocols and algorithms that is acceptable to the IPsec routers.

SUMMARY STEPS

1. **enable**
2. **configure terminal**
3. **crypto ipsec transform-set** *transform-set-name transform1* [*transform2*] [*transform3*] [*transform4*]
4. **crypto ipsec profile** *name*
5. **set transform-set** *transform-set-name* [*transform-set-name2*...*transform-set-name6*]

DETAILED STEPS

	Command or Action	Purpose
Step 1	enable Example: Router> enable	Enables privileged EXEC mode. <ul style="list-style-type: none">Enter your password if prompted.
Step 2	configure terminal Example: Router# configure terminal	Enters global configuration mode.
Step 3	crypto ipsec transform-set <i>transform-set-name</i> <i>transform1</i> [<i>transform2</i>] [<i>transform3</i>] [<i>transform4</i>] Example: Router(config)# crypto ipsec transform-set myset0 ah-sha-hmac esp-3des	Defines a transform set, and places the router in crypto transform configuration mode.
Step 4	crypto ipsec profile <i>name</i> Example: Router(config)# crypto ipsec profile profile0	Defines the IPsec parameters that are to be used for IPsec encryption between two IPsec routers.
Step 5	set transform-set <i>transform-set-name</i> [<i>transform-set-name2</i> ... <i>transform-set-name6</i>] Example: Router (config-crypto-transform)# set-transform-set myset0	Specifies which transform sets can be used with the crypto map entry.

Configuring an ISAKMP Profile in IPv6

This optional task describes how to configure an ISAKMP profile in IPv6.

SUMMARY STEPS

1. **enable**
2. **configure terminal**
3. **crypto isakmp profile** *profile-name* [**accounting** *aaalist*]
4. **self-identity** {**address** | **address ipv6**} | **fqdn** | **user-fqdn** *user-fqdn*}
5. **match identity** {**group** *group-name* | **address** {*address* [*mask*] [*fvrfl*] | **ipv6** *ipv6-address*} | **host** *host-name* | **host domain** *domain-name* | **user** *user-fqdn* | **user domain** *domain-name*}

DETAILED STEPS

	Command or Action	Purpose
Step 1	enable Example: Router> enable	Enables privileged EXEC mode. <ul style="list-style-type: none"> Enter your password if prompted.
Step 2	configure terminal Example: Router# configure terminal	Enters global configuration mode.
Step 3	crypto isakmp profile <i>profile-name</i> [accounting <i>aaalist</i>] Example: Router(config)# crypto ipsec profile profile1	Defines an ISAKMP profile and audits IPsec user sessions.
Step 4	self-identity (address address ipv6) fqdn user-fqdn <i>user-fqdn</i>) Example: Router(config-isakmp-profile)# self-identity address ipv6	Defines the identity that the local IKE uses to identify itself to the remote peer.
Step 5	match identity { group <i>group-name</i> address { <i>address</i> [<i>mask</i>] [<i>fvrfl</i>] ipv6 <i>ipv6-address</i> } host <i>host-name</i> host domain <i>domain-name</i> user <i>user-fqdn</i> user domain <i>domain-name</i> } Example: Router(config-isakmp-profile)# match identity address ipv6 3FFE:2002::A8BB:CCFF:FE01:2C02/128	Matches an identity from a remote peer in an ISAKMP profile.

Configuring IPv6 IPsec VTI

This task describes how to configure and enable IPv6 IPsec virtual tunnel mode for IPv6.

Prerequisites

Use the **ipv6 unicast-routing** command to enable IPv6 unicast routing.

SUMMARY STEPS

- enable**
- configure terminal**
- ipv6 unicast-routing**
- interface tunnel** *tunnel-number*
- ipv6 address** *ipv6-address/prefix*
- ipv6 enable**

7. **tunnel source** {*ip-address* | *ipv6-address* | *interface-type interface-number*}
8. **tunnel destination** {*host-name* | *ip-address* | *ipv6-address*}
9. **tunnel mode** {*aurp* | *cayman* | *dvmrp* | *eon* | *gre* | *gre multipoint* | *gre ipv6* | *ipip* [*decapsulate-any*] | *ipsec ipv4* | *iptalk* | *ipv6* | *ipsec ipv6* | *mpls* | *nos* | *rbscp*}
10. **tunnel protection ipsec profile** *name* [*shared*]

DETAILED STEPS

	Command or Action	Purpose
Step 1	enable Example: Router> enable	Enables privileged EXEC mode. <ul style="list-style-type: none">• Enter your password if prompted.
Step 2	configure terminal Example: Router# configure terminal	Enters global configuration mode.
Step 3	ipv6 unicast-routing Example: Router(config)# ipv6 unicast-routing	Enables IPv6 unicast routing. You only need to enable IPv6 unicast routing once, not matter how many interface tunnels you want to configure.
Step 4	interface tunnel <i>tunnel-number</i> Example: Router(config)# interface tunnel 0	Specifies a tunnel interface and number, and enters interface configuration mode.
Step 5	ipv6 address <i>ipv6-address/prefix</i> Example: Router(config-if)# ipv6 address 3FFE:C000:0:7::/64 eui-64	Provides an IPv6 address to this tunnel interface, so that IPv6 traffic can be routed to this tunnel.
Step 6	ipv6 enable Example: Router(config-if)# ipv6 enable	Enables IPv6 on this tunnel interface.
Step 7	tunnel source { <i>ip-address</i> <i>ipv6-address</i> <i>interface-type interface-number</i> } Example: Router(config-if)# tunnel source ethernet0	Sets the source address for a tunnel interface.
Step 8	tunnel destination { <i>host-name</i> <i>ip-address</i> <i>ipv6-address</i> } Example: Router(config-if)# tunnel destination 2001:0DB8:1111:2222::1	Specifies the destination for a tunnel interface.

	Command or Action	Purpose
Step 9	<pre>tunnel mode {aurp cayman dvmrp eon gre gre multipoint gre ipv6 ipip [decapsulate-any] ipsec ipv4 iptalk ipv6 ipsec ipv6 mpls nos rbscp}</pre> <p>Example: Router(config-if)# tunnel mode ipsec ipv6</p>	Sets the encapsulation mode for the tunnel interface. For IPsec, only the ipsec ipv6 keywords are supported.
Step 10	<pre>tunnel protection ipsec profile name [shared]</pre> <p>Example: Router(config-if)# tunnel protection ipsec profile profile1</p>	Associates a tunnel interface with an IPsec profile. IPv6 does not support the shared keyword.

Verifying IPsec Tunnel Mode Configuration

This optional task describes how to display information to verify IPsec tunnel mode configuration. Use the following commands as needed to verify configuration and operation.

SUMMARY STEPS

1. **show adjacency** [**summary** [*interface-type interface-number*]] | [*prefix*] [*interface interface-number*] [**connectionid** *id*] [**link** {**ipv4** | **ipv6** | **mpls**}] [**detail**]
2. **show crypto engine** {**accelerator** | **brief** | **configuration** | **connections** [**active** | **dh** | **dropped-packet** | **show**] | **qos**}
3. **show crypto ipsec sa** [**ipv6**] [*interface-type interface-number*] [**detailed**]
4. **show crypto isakmp peer** [**config** | **detail**]
5. **show crypto isakmp policy**
6. **show crypto isakmp profile**
7. **show crypto map** [**interface** *interface* | **tag** *map-name*]
8. **show crypto session** [**detail**] | [**local** *ip-address* [**port** *local-port*] | [**remote** *ip-address* [**port** *remote-port*]]] | [**detail**] | [**fvrf** *vrf-name*] | [**ivrf** *vrf-name*]
9. **show crypto socket**
10. **show ipv6 access-list** [*access-list-name*]
11. **show ipv6 cef** [**vrf**] [*ipv6-prefix/prefix-length*] | [*interface-type interface-number*] [**longer-prefixes** | **similar-prefixes** | **detail** | **internal** | **platform** | **epoch** | **source**]
12. **show interface** *type number* **stats**

DETAILED STEPS

	Command or Action	Purpose
Step 1	<pre>show adjacency [summary [interface-type interface-number]] [prefix] [interface interface-number] [connectionid id] [link {ipv4 ipv6 mpls}] [detail]</pre> <p>Example: Router# show adjacency detail</p>	Displays information about the CEF adjacency table or the hardware Layer 3-switching adjacency table.
Step 2	<pre>show crypto engine {accelerator brief configuration connections [active dh dropped-packet show] qos}</pre> <p>Example: Router# show crypto engine connection active</p>	Displays a summary of the configuration information for the crypto engines.
Step 3	<pre>show crypto ipsec sa [ipv6] [interface-type interface-number] [detailed]</pre> <p>Example: Router# show crypto ipsec sa ipv6</p>	Displays the settings used by current SAs in IPv6.
Step 4	<pre>show crypto isakmp peer [config detail]</pre> <p>Example: Router# show crypto isakmp peer detail</p>	Displays peer descriptions.
Step 5	<pre>show crypto isakmp policy</pre> <p>Example: Router# show crypto isakmp policy</p>	Displays the parameters for each IKE policy.
Step 6	<pre>show crypto map [interface interface tag map-name]</pre> <p>Example: Router# show crypto map</p>	<p>Displays the crypto map configuration.</p> <p>The crypto maps shown in this command output are dynamically generated. The user does not have to configure crypto maps.</p>
Step 7	<pre>show crypto session [detail] [local ip-address [port local-port] [remote ip-address [port remote-port]] [detail]] [fvfr vrf-name] [ivrf vrf-name]</pre> <p>Example: Router# show crypto session</p>	<p>Displays status information for active crypto sessions.</p> <p>IPv6 does not support the fvfr or ivrf keywords or the <i>vrf-name</i> argument.</p>
Step 8	<pre>show crypto socket</pre> <p>Example: Router# show crypto socket</p>	Lists crypto sockets.

	Command or Action	Purpose
Step 9	show ipv6 access-list [<i>access-list-name</i>] Example: Router# show ipv6 access-list	Displays the contents of all current IPv6 access lists.
Step 10	show ipv6 cef [<i>ipv6-prefix/prefix-length</i>] [<i>interface-type interface-number</i>] [<i>longer-prefixes</i> <i>similar-prefixes</i> <i>detail</i> <i>internal</i> <i>platform</i> <i>epoch</i> <i>source</i>] Example: Router# show ipv6 cef	Displays entries in the IPv6 Forwarding Information Base (FIB).
Step 11	show interface type number stats Example: Router# show interface fddi 3/0/0 stats	Displays numbers of packets that were process switched, fast switched, and distributed switched.

Troubleshooting IPsec for IPv6 Configuration and Operation

This optional task explains how to display information to troubleshoot the configuration and operation of IPv6 IPsec. Use the following commands only as needed to verify configuration and operation.

SUMMARY STEPS

1. **enable**
2. **debug crypto ipsec [error]**
3. **debug crypto engine packet [detail] [error]**
4. **debug crypto isakmp [error]**
5. **debug crypto socket [error]**

DETAILED STEPS

	Command or Action	Purpose
Step 1	enable Example: Router# enable	Enables privileged EXEC mode. <ul style="list-style-type: none"> • Enter your password if prompted.

	Command or Action	Purpose
Step 2	<code>debug crypto ipsec</code> Example: Router# <code>debug crypto ipsec</code>	Displays IPsec network events.
Step 3	<code>debug crypto engine packet [detail]</code> Example: Router# <code>debug crypto engine packet</code>	Displays the contents of IPv6 packets.  Caution Using this command could flood the system and increase CPU if several packets are being encrypted.

Examples

This section provides the following output examples:

- [Sample Output for the show crypto ipsec sa Command, page 229](#)
- [Sample Output for the show crypto isakmp peer Command, page 230](#)
- [Sample Output for the show crypto isakmp profile Command, page 230](#)
- [Sample Output for the show crypto isakmp sa Command, page 231](#)
- [Sample Output for the show crypto map Command, page 231](#)
- [Sample Output for the show crypto session Command, page 231](#)

Sample Output for the show crypto ipsec sa Command

The following is sample output from the `show crypto ipsec sa` command:

```
Router# show crypto ipsec sa

interface: Tunnel0
  Crypto map tag: Tunnel0-head-0, local addr 3FFE:2002::A8BB:CCFF:FE01:9002

  protected vrf: (none)
  local ident (addr/mask/prot/port): (::/0/0/0)
  remote ident (addr/mask/prot/port): (::/0/0/0)
  current_peer 3FFE:2002::A8BB:CCFF:FE01:2C02 port 500
    PERMIT, flags={origin_is_acl,}
    #pkts encaps: 133, #pkts encrypt: 133, #pkts digest: 133
    #pkts decaps: 133, #pkts decrypt: 133, #pkts verify: 133
    #pkts compressed: 0, #pkts decompressed: 0
    #pkts not compressed: 0, #pkts compr. failed: 0
    #pkts not decompressed: 0, #pkts decompress failed: 0
    #send errors 60, #recv errors 0

  local crypto endpt.: 3FFE:2002::A8BB:CCFF:FE01:9002,
  remote crypto endpt.: 3FFE:2002::A8BB:CCFF:FE01:2C02
  path mtu 1514, ip mtu 1514
  current outbound spi: 0x28551D9A(676666778)

  inbound esp sas:
    spi: 0x2104850C(553944332)
      transform: esp-des ,
      in use settings ={Tunnel, }
      conn id: 93, flow_id: SW:93, crypto map: Tunnel0-head-0
      sa timing: remaining key lifetime (k/sec): (4397507/148)
```

```

IV size: 8 bytes
replay detection support: Y
Status: ACTIVE

inbound ah sas:
spi: 0x967698CB(2524354763)
  transform: ah-sha-hmac ,
  in use settings =(Tunnel, )
  conn id: 93, flow_id: SW:93, crypto map: Tunnel0-head-0
  sa timing: remaining key lifetime (k/sec): (4397507/147)
  replay detection support: Y
  Status: ACTIVE

inbound pcp sas:

outbound esp sas:
spi: 0x28551D9A(676666778)
  transform: esp-des ,
  in use settings =(Tunnel, )
  conn id: 94, flow_id: SW:94, crypto map: Tunnel0-head-0
  sa timing: remaining key lifetime (k/sec): (4397508/147)
  IV size: 8 bytes
  replay detection support: Y
  Status: ACTIVE

outbound ah sas:
spi: 0xA83E05B5(2822636981)
  transform: ah-sha-hmac ,
  in use settings =(Tunnel, )
  conn id: 94, flow_id: SW:94, crypto map: Tunnel0-head-0
  sa timing: remaining key lifetime (k/sec): (4397508/147)
  replay detection support: Y
  Status: ACTIVE

outbound pcp sas:

```

Sample Output for the show crypto isakmp peer Command

The following sample output shows peer descriptions on an IPv6 router:

```

Router# show crypto isakmp peer detail

Peer: 2001:0DB8:0:1::1 Port: 500 Local: 2001:0DB8:0:2::1
Phase1 id: 2001:0DB8:0:1::1
flags:
NAS Port: 0 (Normal)
IKE SAs: 1 IPsec SA bundles: 1
last_locker: 0x141A188, last_last_locker: 0x0
last_unlocker: 0x0, last_last_unlocker: 0x0

```

Sample Output for the show crypto isakmp profile Command

The following sample output shows the ISAKMP profiles that are defined on an IPv6 router.

```

Router# show crypto isakmp profile

ISAKMP PROFILE tom
Identities matched are:
ipv6-address 2001:0DB8:0:1::1/32
Certificate maps matched are:
Identity presented is: ipv6-address fqdn
keyring(s): <none>
trustpoint(s): <all>

```

Sample Output for the show crypto isakmp sa Command

The following sample output shows the SAs of an active IPv6 device. The IPv4 device is inactive:

```
Router# show crypto isakmp sa detail

Codes: C - IKE configuration mode, D - Dead Peer Detection
       K - Keepalives, N - NAT-traversal
       X - IKE Extended Authentication
       psk - Preshared key, rsig - RSA signature
       renc - RSA encryption
IPv4 Crypto ISAKMP SA

C-id Local Remote I-VRF Status Encr Hash Auth DH
Lifetime Cap.

IPv6 Crypto ISAKMP SA

dst: 3FFE:2002::A8BB:CCFF:FE01:2C02
src: 3FFE:2002::A8BB:CCFF:FE01:9002
conn-id: 1001 I-VRF: Status: ACTIVE Encr: des Hash: sha Auth:
psk
DH: 1 Lifetime: 23:45:00 Cap: D Engine-id:Conn-id = SW:1

dst: 3FFE:2002::A8BB:CCFF:FE01:2C02
src: 3FFE:2002::A8BB:CCFF:FE01:9002
conn-id: 1002 I-VRF: Status: ACTIVE Encr: des Hash: sha Auth: psk
DH: 1 Lifetime: 23:45:01 Cap: D Engine-id:Conn-id = SW:2
```

Sample Output for the show crypto map Command

The following sample output shows the dynamically generated crypto maps of an active IPv6 device:

```
Router# show crypto map

Crypto Map "Tunnell-head-0" 65536 ipsec-isakmp
  Profile name: profile0
  Security association lifetime: 4608000 kilobytes/300 seconds
  PFS (Y/N): N
  Transform sets={
    ts,
  }

Crypto Map "Tunnell-head-0" 65537
  Map is a PROFILE INSTANCE.
  Peer = 2001:1::2

IPv6 access list Tunnell-head-0-ACL (crypto)
  permit ipv6 any any (61445999 matches) sequence 1
  Current peer: 2001:1::2
  Security association lifetime: 4608000 kilobytes/300 seconds
  PFS (Y/N): N
  Transform sets={
    ts,
  }
  Interfaces using crypto map Tunnell-head-0:
  Tunnell
```

Sample Output for the show crypto session Command

The following output from the show crypto session information provides details on currently active crypto sessions:

```
Router# show crypto session detail
```

```

Crypto session current status

Code: C - IKE Configuration mode, D - Dead Peer Detection K - Keepalives, N -
NAT-traversal, X - IKE Extended Authentication

Interface: Tunnel1
Session status: UP-ACTIVE
Peer: 2001:1::1 port 500 fvrf: (none) ivrf: (none)
      Phase1_id: 2001:1::1
      Desc: (none)
      IKE SA: local 2001:1::2/500
              remote 2001:1::1/500 Active
              Capabilities:(none) connid:14001 lifetime:00:04:32
IPSEC FLOW: permit ipv6 ::/0 ::/0
      Active SAs: 4, origin: crypto map
      Inbound:  #pkts dec'ed 42641 drop 0 life (KB/Sec) 4534375/72
      Outbound: #pkts enc'ed 6734980 drop 0 life (KB/Sec) 2392402/72

```

Configuration Examples for IPsec for IPv6 Security

This section provides the following configuration example:

- [Configuring a VTI for Site-to-Site IPv6 IPsec Protection: Example, page 232](#)

Configuring a VTI for Site-to-Site IPv6 IPsec Protection: Example

The following example shows configuration for a single IPv6 IPsec tunnel:

```

crypto isakmp policy 1
  authentication pre-share
!
crypto isakmp key myPreshareKey0 address ipv6 3FFE:2002::A8BB:CCFF:FE01:2C02/128
crypto isakmp keepalive 30 30
!
crypto ipsec transform-set 3des ah-sha-hmac esp-3des
!
crypto ipsec profile profile0
  set transform-set 3des
!
ipv6 cef
!
interface Tunnel0
  ipv6 address 3FFE:1001::/64 eui-64
  ipv6 enable
  ipv6 cef
  tunnel source Ethernet2/0
  tunnel destination 3FFE:2002::A8BB:CCFF:FE01:2C02
  tunnel mode ipsec ipv6
  tunnel protection ipsec profile profile0

```

Additional References

For additional information related to implementing security for IPv6, see the following sections.

Related Documents

Related Topic	Document Title
OSPF for IPv6 authentication support with IPsec	<i>Implementing OSPF for IPv6</i> , Release 12.4
IPsec VTI information	<i>IPsec Virtual Tunnel Interface</i> , Release 12.3(14)T
IPv6 supported feature list	<i>Start Here: Cisco IOS Software Release Specifics for IPv6 Features</i>
IPv6 commands: complete command syntax, command mode, defaults, usage guidelines, and examples	<i>IPv6 for Cisco IOS Command Reference</i>
IPv4 security configuration tasks	<i>Cisco IOS Security Configuration Guide</i> , Release 12.4
IPv4 security commands: complete command syntax, command mode, defaults, usage guidelines, and examples	<i>Cisco IOS Security Command Reference</i> , Release 12.4
IPv4 configuration and command reference information	<i>Cisco IOS Release 12.4 Configuration Guides and Command References</i>

Standards

Standards	Title
No new or modified standards are supported by this feature, and support for existing standards has not been modified by this feature.	—

MIBs

MIBs	MIBs Link
No new or modified MIBs are supported by this feature, and support for existing MIBs has not been modified by this feature.	To locate and download MIBs for selected platforms, Cisco IOS releases, and feature sets, use Cisco MIB Locator found at the following URL: http://www.cisco.com/go/mibs

RFCs

RFCs	Title
RFC 2401	<i>Security Architecture for the Internet Protocol</i>
RFC 2402	<i>IP Authentication Header</i>
RFC 2404	<i>The Use of Hash Message Authentication Code Federal Information Processing Standard 180-1 within Encapsulating Security Payload and Authentication Header</i>
RFC 2406	<i>IP Encapsulating Security Payload (ESP)</i>
RFC 2407	<i>The Internet Security Domain of Interpretation for ISAKMP</i>
RFC 2408	<i>Internet Security Association and Key Management Protocol (ISAKMP)</i>
RFC 2409	<i>Internet Key Exchange (IKE)</i>
RFC 2460	<i>Internet Protocol, Version 6 (IPv6) Specification</i>
RFC 2474	<i>Definition of the Differentiated Services Field (DS Field) in the IPv4 and IPv6 Headers</i>
RFC 3576	<i>Change of Authorization</i>

Technical Assistance

Description	Link
The Cisco Technical Support website contains thousands of pages of searchable technical content, including links to products, technologies, solutions, technical tips, and tools. Registered Cisco.com users can log in from this page to access even more content.	http://www.cisco.com/techsupport



Implementing IS-IS for IPv6

This module describes how to configure Integrated Intermediate System-to-Intermediate System (IS-IS) for IPv6. IS-IS is an Interior Gateway Protocol (IGP) that advertises link-state information throughout the network to create a picture of the network topology. IS-IS is an Open Systems Interconnection (OSI) hierarchical routing protocol that designates an intermediate system as a Level 1 or Level 2 device. Level 2 devices route between Level 1 areas to create an intradomain routing backbone. Integrated IS-IS uses a single routing algorithm to support several network address families, such as IPv6, IPv4, and OSI.

Finding Support Information for Platforms and Cisco IOS Software Images

Use Cisco Feature Navigator to find information about platform support and Cisco IOS software image support. Access Cisco Feature Navigator at <http://www.cisco.com/go/fn>. You must have an account on Cisco.com. If you do not have an account or have forgotten your username or password, click **Cancel** at the login dialog box and follow the instructions that appear.

Contents

- [Prerequisites for Implementing IS-IS for IPv6, page 235](#)
- [Restrictions for Implementing IS-IS for IPv6, page 236](#)
- [Information About Implementing IS-IS for IPv6, page 236](#)
- [How to Implement IS-IS for IPv6, page 238](#)
- [Configuration Examples for IPv6 IS-IS, page 253](#)
- [Where to Go Next, page 254](#)
- [Additional References, page 255](#)

Prerequisites for Implementing IS-IS for IPv6

- This module assumes that you are familiar with IPv4. Refer to the publications referenced in the “[Related Documents](#)” section for IPv4 configuration and command reference information.
- This module assumes that you are familiar with IPv6 addressing and basic configuration. Refer to the *Implementing Basic Connectivity for IPv6* module for more information.

Table 17 identifies the earliest release for each early-deployment train in which the feature became available.

Table 17 Minimum Required Cisco IOS Release

Feature	Minimum Required Cisco IOS Release by Release Train
Enhancements for IS-IS	12.2(8)T, 12.0(21)ST, 12.0(22)S, 12.2(14)S, 12.3, 12.3(2)T, 12.4, 12.4(2)T, 12.2(28)SB, 12.2(33)SRA
Redistributing routes into an IPv6 IS-IS routing process	12.2(8)T, 12.0(21)ST, 12.0(22)S, 12.2(14)S, 12.3, 12.3(2)T, 12.4, 12.4(2)T, 12.2(28)SB, 12.2(33)SRA
Redistributing IPv6 IS-IS routes between IS-IS levels	12.2(8)T, 12.0(21)ST, 12.0(22)S, 12.2(14)S, 12.3, 12.3(2)T, 12.4, 12.4(2)T, 12.2(28)SB, 12.2(33)SRA
Disabling IPv6 protocol-support consistency checks	12.2(8)T, 12.0(21)ST, 12.0(22)S, 12.2(14)S, 12.3, 12.3(2)T, 12.4, 12.4(2)T, 12.2(28)SB
IS-IS multitopology support for IS-IS	12.2(15)T, 12.2(18)S, 12.0(26)S, 12.3, 12.3(2)T, 12.4, 12.4(2)T, 12.2(28)SB, 12.2(33)SRA
IPv6 IS-IS local routing information base (RIB)	12.3(4)T, 12.2(25)S, 12.4, 12.4(2)T, 12.2(28)SB, 12.2(33)SRA

Restrictions for Implementing IS-IS for IPv6

In Cisco IOS Release 12.0(21)ST, Cisco IOS Release 12.0(22)S or later releases, and Cisco IOS Release 12.2(8)T or later releases, IS-IS support for IPv6 implements single-topology IPv6 IS-IS functionality based on IETF IS-IS WG *draft-ietf-isis-ipv6.txt*. A single shortest path first (SPF) per level is used to compute OSI, IPv4 (if configured), and IPv6 routes. The use of a single SPF means that both IPv4 IS-IS and IPv6 IS-IS routing protocols must share a common network topology. To use IS-IS for IPv4 and IPv6 routing, any interface configured for IPv4 IS-IS must also be configured for IPv6 IS-IS, and vice versa. All routers within an IS-IS area (Level 1 routing) or domain (Level 2 routing) must also support the same set of address families: IPv4 only, IPv6 only, or both IPv4 and IPv6.

Beginning with release Cisco IOS Release 12.2(15)T, IS-IS support for IPv6 is enhanced to also support multitopology IPv6 support as defined in IETF IS-IS WG *draft-ietf-isis-wg-multi-topology.txt*. Multitopology IPv6 IS-IS support uses multiple SPFs to compute routes and removes the restriction that all interfaces must support all configured address families and that all routers in an IS-IS area or domain must support the same set of address families.

The following IS-IS router configuration commands are specific to IPv4 and are not supported by, or have any effect on, IPv6 IS-IS:

- **mpls**
- **traffic-share**

Information About Implementing IS-IS for IPv6

To configure IS-IS for IPv6, you need to understand the following concept:

- [IS-IS Enhancements for IPv6, page 237](#)

IS-IS Enhancements for IPv6

IS-IS in IPv6 functions the same and offers many of the same benefits as IS-IS in IPv4. IPv6 enhancements to IS-IS allow IS-IS to advertise IPv6 prefixes in addition to IPv4 and OSI routes. Extensions to the IS-IS command-line interface (CLI) allow configuration of IPv6-specific parameters. IPv6 IS-IS extends the address families supported by IS-IS to include IPv6, in addition to OSI and IPv4. IS-IS in IPv6 supports either single-topology mode or multiple topology mode.

IS-IS Single-Topology Support for IPv6

Single-topology support for IPv6 allows IS-IS for IPv6 to be configured on interfaces along with other network protocols (for example, IPv4 and Connectionless Network Service [CLNS]). All interfaces must be configured with the identical set of network address families. In addition, all routers in the IS-IS area (for Level 1 routing) or the domain (for Level 2 routing) must support the identical set of network layer address families on all interfaces.

When single-topology support for IPv6 is being used, either old- or new-style TLVs may be used. However, the TLVs used to advertise reachability to IPv6 prefixes use extended metrics. Cisco routers do not allow an interface metric to be set to a value greater than 63 if the configuration is not set to support only new-style TLVs for IPv4. In single-topology IPv6 mode, the configured metric is always the same for both IPv4 and IPv6.

IS-IS Multitopology Support for IPv6

IS-IS multitopology support for IPv6 allows IS-IS to maintain a set of independent topologies within a single area or domain. This mode removes the restriction that all interfaces on which IS-IS is configured must support the identical set of network address families. It also removes the restriction that all routers in the IS-IS area (for Level 1 routing) or domain (for Level 2 routing) must support the identical set of network layer address families. Because multiple SPF calculations are performed, one for each configured topology, it is sufficient that connectivity exists among a subset of the routers in the area or domain for a given network address family to be routable.

You can use the **isis ipv6 metric** command to configure different metrics on an interface for IPv6 and IPv4.

When multitopology support for IPv6 is used, use the **metric-style wide** command to configure IS-IS to use new-style TLVs because TLVs used to advertise IPv6 information in link-state packets (LSPs) are defined to use only extended metrics.

Transition from Single-Topology to Multitopology Support for IPv6

All routers in the area or domain must use the same type of IPv6 support, either single-topology or multitopology. A router operating in multitopology mode will not recognize the ability of the single-topology mode router to support IPv6 traffic, which will lead to holes in the IPv6 topology. To transition from single-topology support to the more flexible multitopology support, a multitopology transition mode is provided.

The multitopology transition mode allows a network operating in single-topology IS-IS IPv6 support mode to continue to work while upgrading routers to include multitopology IS-IS IPv6 support. While in transition mode, both types of TLVs (single-topology and multitopology) are sent in LSPs for all configured IPv6 addresses, but the router continues to operate in single-topology mode (that is, the topological restrictions of the single-topology mode are still in effect). After all routers in the area or domain have been upgraded to support multitopology IPv6 and are operating in transition mode,

transition mode can be removed from the configuration. Once all routers in the area or domain are operating in multitopology IPv6 mode, the topological restrictions of single-topology mode are no longer in effect.

IPv6 IS-IS Local RIB

A router that is running IS-IS IPv6 maintains a local RIB in which it stores all routes to destinations it has learned from its neighbors. At the end of each SPF, IS-IS attempts to install the best (that is, the least-cost) routes to a destination present in the local RIB in the global IPv6 routing table.

For further information on the IPv6 IS-IS local RIB, see the [Verifying IPv6 IS-IS Configuration and Operation](#) section.

How to Implement IS-IS for IPv6

When configuring supported routing protocols in IPv6, you must create the routing process, enable the routing process on interfaces, and customize the routing protocol for your particular network.



Note

The following sections describe the configuration tasks for creating an IPv6 IS-IS routing process and enabling the routing process on interfaces. The following sections do not provide in-depth information on customizing IS-IS because the protocol functions the same in IPv6 as it does in IPv4. Refer to the publications referenced in the “[Related Documents](#)” section for further IPv6 and IPv4 configuration and command reference information.

The tasks in the following sections explain how to configure IPv6 IS-IS. Each task in the list is identified as either required or optional:

- [Configuring Single-Topology IS-IS for IPv6, page 238](#) (required)
- [Configuring Multitopology IS-IS for IPv6, page 240](#) (optional)
- [Customizing IPv6 IS-IS, page 242](#) (optional)
- [Redistributing Routes into an IPv6 IS-IS Routing Process, page 244](#) (optional)
- [Redistributing IPv6 IS-IS Routes Between IS-IS Levels, page 245](#) (optional)
- [Disabling IPv6 Protocol-Support Consistency Checks, page 246](#) (optional)
- [Verifying IPv6 IS-IS Configuration and Operation, page 248](#) (optional)

Configuring Single-Topology IS-IS for IPv6

This task explains how to create an IPv6 IS-IS process and enable IPv6 IS-IS support on an interface.

Configuring IS-IS comprises two activities. The first activity creates an IS-IS routing process and is performed using protocol-independent IS-IS commands. The second activity in configuring IPv6 IS-IS configures the operation of the IS-IS protocol on an interface.

Prerequisites

Before configuring the router to run IPv6 IS-IS, globally enable IPv6 using the **ipv6 unicast-routing** global configuration command. For details on basic IPv6 connectivity tasks, refer to the *Implementing Basic Connectivity for IPv6* module.

Restrictions

If you are using IS-IS single-topology support for IPv6, IPv4, or both IPv6 and IPv4, you may configure both IPv6 and IPv4 on an IS-IS interface for Level 1, Level 2, or both Level 1 and Level 2. However, if both IPv6 and IPv4 are configured on the same interface, they must be running the same IS-IS level. That is, IPv4 cannot be configured to run on IS-IS Level 1 only on a specified Ethernet interface while IPv6 is configured to run IS-IS Level 2 only on the same Ethernet interface.

SUMMARY STEPS

1. **enable**
2. **configure terminal**
3. **router isis** *area-tag*
4. **net** *network-entity-title*
5. **exit**
6. **interface** *type number*
7. **ipv6 address** { *ipv6-address/prefix-length* | *prefix-name sub-bits/prefix-length* }
8. **ipv6 router isis** *area-name*

DETAILED STEPS

	Command or Action	Purpose
Step 1	enable Example: Router> enable	Enables privileged EXEC mode. <ul style="list-style-type: none">• Enter your password if prompted.
Step 2	configure terminal Example: Router# configure terminal	Enters global configuration mode.
Step 3	router isis <i>area-tag</i> Example: Router(config)# router isis area2	Enables IS-IS for the specified IS-IS routing process, and enters router configuration mode.

	Command or Action	Purpose
Step 4	<pre>net network-entity-title</pre> <p>Example: Router(config-router)# net 49.0001.0000.0000.000c.00 </p>	<p>Configures an IS-IS network entity title (NET) for the routing process.</p> <ul style="list-style-type: none"> The <i>network-entity-title</i> argument defines the area addresses for the IS-IS area and the system ID of the router. <p>Note For more details about the format of the <i>network-entity-title</i> argument, refer to the “Configuring ISO CLNS” chapter in <i>Cisco IOS Apollo Domain, Banyan VINES, DECnet, IOS CLNS, XNS Configuration Guide</i>, Release 12.4.</p>
Step 5	<pre>exit</pre> <p>Example: Router(config-router)# exit </p>	<p>Exits router configuration mode and enters global configuration mode.</p>
Step 6	<pre>interface type number</pre> <p>Example: Router(config)# interface Ethernet 0/0/1 </p>	<p>Specifies the interface type and number, and enters interface configuration mode.</p>
Step 7	<pre>ipv6 address {ipv6-address/prefix-length prefix-name sub-bits/prefix-length}</pre> <p>Example: Router(config-if)# ipv6 address 2001:0DB8::3/64 </p>	<p>Specifies the IPv6 network assigned to the interface and enables IPv6 processing on the interface.</p> <p>Note Refer to the <i>Configuring Basic Connectivity for IPv6</i> module for more information on configuring IPv6 addresses.</p>
Step 8	<pre>ipv6 router isis area-name</pre> <p>Example: Router(config-if)# ipv6 router isis area2 </p>	<p>Enables the specified IPv6 IS-IS routing process on an interface.</p>

Configuring Multitopology IS-IS for IPv6

This task explains how to configure multitopology IS-IS in IPv6.

When multitopology IS-IS for IPv6 is configured, the **transition** keyword allows a user who is working with the single-topology SPF mode of IS-IS IPv6 to continue to work while upgrading to multitopology IS-IS. After every router is configured with the **transition** keyword, users can remove the **transition** keyword on each router. When transition mode is not enabled, IPv6 connectivity between routers operating in single-topology mode and routers operating in multitopology mode is not possible.

You can continue to use the existing IPv6 topology while upgrading to multitopology IS-IS. The optional **isis ipv6 metric** command allows you to differentiate between link costs for IPv6 and IPv4 traffic when operating in multitopology mode.

Prerequisites

Perform the following steps after you have configured IS-IS for IPv6.

SUMMARY STEPS

1. **enable**
2. **configure terminal**
3. **router isis *area-tag***
4. **metric-style wide [transition] [level-1 | level-2 | level-1-2]**
5. **address-family ipv6 [unicast | multicast]**
6. **multi-topology [transition]**

DETAILED STEPS

	Command or Action	Purpose
Step 1	enable Example: Router> enable	Enables privileged EXEC mode. <ul style="list-style-type: none"> • Enter your password if prompted.
Step 2	configure terminal Example: Router# configure terminal	Enters global configuration mode.
Step 3	router isis <i>area-tag</i> Example: Router(config)# router isis area2	Enables IS-IS for the specified IS-IS routing process, and enters router configuration mode.
Step 4	metric-style wide [transition] [level-1 level-2 level-1-2] Example: Router(config-router)# metric-style wide level-1	Configures a router running IS-IS to generate and accept only new-style TLVs.
Step 5	address-family ipv6 [unicast multicast] Example: Router(config-router)# address-family ipv6	Specifies the IPv6 address family, and enters address family configuration mode. <ul style="list-style-type: none"> • The unicast keyword specifies the unicast IPv6 unicast address family. By default, the router is placed in configuration mode for the unicast IPv6 address family if the unicast keyword is not specified with the address-family ipv6 command.
Step 6	multi-topology [transition] Example: Router(config-router-af)# multi-topology	Enables multitopology IS-IS for IPv6. <ul style="list-style-type: none"> • The optional transition keyword allows an IS-IS IPv6 user to continue to use single-topology mode while upgrading to multitopology mode.

Customizing IPv6 IS-IS

This task explains how to configure a new administrative distance for IPv6 IS-IS, configure the maximum number of equal-cost paths that IPv6 IS-IS will support, configure summary prefixes for IPv6 IS-IS, and configure an IS-IS instance to advertise the default IPv6 route (::/0). It also explains how to configure the hold-down period between partial route calculations (PRCs) and how often Cisco IOS software performs the SPF calculation when using multitopology IS-IS.

You can customize IS-IS multitopology for IPv6 for your network, but you likely will not need to do so. The defaults for this feature are set to meet the requirements of most customers and features. If you change the defaults, refer to the IPv4 configuration guide and the IPv6 command reference to find the appropriate syntax.

SUMMARY STEPS

1. **enable**
2. **configure terminal**
3. **router isis** *area-tag*
4. **address-family ipv6** [**unicast** | **multicast**]
5. **default-information originate** [**route-map** *map-name*]
6. **distance** *value*
7. **maximum-paths** *number-paths*
8. **summary-prefix** *ipv6-prefix/prefix-length* [**level-1** | **level-1-2** | **level-2**]
9. **prc-interval** *seconds* [*initial-wait*] [*secondary-wait*]
10. **spf-interval** [**level-1** | **level-2**] *seconds* [*initial-wait*] [*secondary-wait*]
11. **exit**
12. **interface** *type number*
13. **isis ipv6 metric** *metric-value* [**level-1** | **level-2** | **level-1-2**]

DETAILED STEPS

	Command or Action	Purpose
Step 1	enable Example: Router> enable	Enables privileged EXEC mode. <ul style="list-style-type: none">• Enter your password if prompted.
Step 2	configure terminal Example: Router# configure terminal	Enters global configuration mode.
Step 3	router isis <i>area-tag</i> Example: Router(config)# router isis area2	Enables IS-IS for the specified IS-IS routing process, and enters router configuration mode.

	Command or Action	Purpose
Step 4	<p>address-family ipv6 [unicast multicast]</p> <p>Example: Router(config-router)# address-family ipv6</p>	<p>Specifies the IPv6 address family, and enters address family configuration mode.</p> <ul style="list-style-type: none"> The unicast keyword specifies the unicast IPv6 unicast address family. By default, the router is placed in configuration mode for the unicast IPv6 address family if the unicast keyword is not specified with the address-family ipv6 command.
Step 5	<p>default-information originate [route-map <i>map-name</i>]</p> <p>Example: Router(config-router-af)# default-information originate</p>	<p>(Optional) Injects a default IPv6 route into an IS-IS routing domain.</p> <ul style="list-style-type: none"> The route-map keyword and <i>map-name</i> argument specify the conditions under which the IPv6 default route is advertised. If the route map keyword is omitted, then the IPv6 default route will be unconditionally advertised at Level 2.
Step 6	<p>distance <i>value</i></p> <p>Example: Router(config-router-af)# distance 90</p>	<p>(Optional) Defines an administrative distance for IPv6 IS-IS routes in the IPv6 routing table.</p> <ul style="list-style-type: none"> The <i>value</i> argument is an integer from 10 to 254. (The values 0 to 9 are reserved for internal use).
Step 7	<p>maximum-paths <i>number-paths</i></p> <p>Example: Router(config-router-af)# maximum-paths 3</p>	<p>(Optional) Defines the maximum number of equal-cost routes that IPv6 IS-IS can support.</p> <ul style="list-style-type: none"> This command also supports IPv6 Border Gateway Protocol (BGP) and Routing Information Protocol (RIP). The <i>number-paths</i> argument is an integer from 1 to 64. The default for BGP is one path; the default for IS-IS and RIP is 16 paths.
Step 8	<p>summary-prefix <i>ipv6-prefix/prefix-length</i> [level-1 level-1-2 level-2]</p> <p>Example: Router(config-router-af)# summary-prefix 2001:0DB8::/24</p>	<p>(Optional) Allows a Level 1-2 router to summarize Level 1 prefixes at Level 2, instead of advertising the Level 1 prefixes directly when the router advertises the summary.</p> <ul style="list-style-type: none"> The <i>ipv6-prefix</i> argument in the summary-prefix command must be in the form documented in RFC 2373 where the address is specified in hexadecimal using 16-bit values between colons. The <i>prefix-length</i> argument is a decimal value that indicates how many of the high-order contiguous bits of the address comprise the prefix (the network portion of the address). A slash mark must precede the decimal value.
Step 9	<p>prc-interval <i>seconds</i> [<i>initial-wait</i>] [<i>secondary-wait</i>]</p> <p>Example: Router(config-router-af)# prc-interval 20</p>	<p>(Optional) Configures the hold-down period between PRCs for multitopology IS-IS for IPv6.</p>

	Command or Action	Purpose
Step 10	spf-interval [<i>level-1</i> <i>level-2</i>] <i>seconds</i> [<i>initial-wait</i>] [<i>secondary-wait</i>] Example: Router(config-router-af)# spf-interval 30	(Optional) Configures how often Cisco IOS software performs the SPF calculation for multitopology IS-IS for IPv6.
Step 11	exit Example: Router(config-router-af)# exit	Exits address family configuration mode, and returns the router to router configuration mode. <ul style="list-style-type: none"> Repeat this step to exit router configuration mode and return the router to global configuration mode.
Step 12	interface <i>type number</i> Example: Router(config-router)# interface Ethernet 0/0/1	Specifies the interface type and number, and enters interface configuration mode.
Step 13	isis ipv6 metric <i>metric-value</i> [<i>level-1</i> <i>level-2</i> <i>level-1-2</i>] Example: Router(config-if)# isis ipv6 metric 20	(Optional) Configures the value of an multitopology IS-IS for IPv6 metric.

Redistributing Routes into an IPv6 IS-IS Routing Process

This task explains how to redistribute IPv6 routes between protocols.

SUMMARY STEPS

1. **enable**
2. **configure terminal**
3. **router isis** *area-tag*
4. **address-family ipv6** [*unicast* | *multicast*]
5. **redistribute** *source-protocol* [*process-id*] [*include-connected*] [*target-protocol-options*] [*source-protocol-options*]

DETAILED STEPS

	Command or Action	Purpose
Step 1	enable Example: Router> enable	Enables privileged EXEC mode. <ul style="list-style-type: none"> Enter your password if prompted.
Step 2	configure terminal Example: Router# configure terminal	Enters global configuration mode.

	Command or Action	Purpose
Step 3	<code>router isis area-tag</code> Example: Router(config)# router isis area2	Enables IS-IS for the specified IS-IS routing process, and enters router configuration mode.
Step 4	<code>address-family ipv6 [unicast multicast]</code> Example: Router(config-router)# address-family ipv6	Specifies the IPv6 address family, and enters address family configuration mode. <ul style="list-style-type: none"> The unicast keyword specifies the unicast IPv6 unicast address family. By default, the router is placed in configuration mode for the unicast IPv6 address family if the unicast keyword is not specified with the address-family ipv6 command.
Step 5	<code>redistribute source-protocol [process-id] [include-connected] [target-protocol-options] [source-protocol-options]</code> Example: Router(config-router-af)# redistribute bgp 64500 metric 100 route-map isismap	Redistributes routes from the specified protocol into the IS-IS process. <ul style="list-style-type: none"> The <i>source-protocol</i> argument can be one of the following keywords: bgp, connected, isis, rip, or static. Only the arguments and keywords relevant to this task are specified here.

Redistributing IPv6 IS-IS Routes Between IS-IS Levels

This task explains how to redistribute IPv6 routes learned at one IS-IS level into a different level.

SUMMARY STEPS

1. **enable**
2. **configure terminal**
3. **router isis area-tag**
4. **address-family ipv6 [unicast | multicast]**
5. **redistribute isis [process-id] {level-1 | level-2} into {level-1 | level-2} distribute-list list-name**

DETAILED STEPS

	Command or Action	Purpose
Step 1	<code>enable</code> Example: Router> enable	Enables privileged EXEC mode. <ul style="list-style-type: none"> Enter your password if prompted.
Step 2	<code>configure terminal</code> Example: Router# configure terminal	Enters global configuration mode.

	Command or Action	Purpose
Step 3	<pre>router isis area-tag</pre> <p>Example: Router(config)# router isis area2</p>	Enables IS-IS for the specified IS-IS routing process, and enters router configuration mode.
Step 4	<pre>address-family ipv6 [unicast multicast]</pre> <p>Example: Router(config-router)# address-family ipv6</p>	<p>Specifies the IPv6 address family, and enters address family configuration mode.</p> <ul style="list-style-type: none"> The unicast keyword specifies the unicast IPv6 unicast address family. By default, the router is placed in configuration mode for the unicast IPv6 address family if the unicast keyword is not specified with the address-family ipv6 command.
Step 5	<pre>redistribute isis [process-id] {level-1 level-2} into {level-1 level-2} distribute-list list-name</pre> <p>Example: Router(config-router-af)# redistribute isis level-1 into level-2</p>	<p>Redistributes IPv6 routes from one IS-IS level into another IS-IS level.</p> <ul style="list-style-type: none"> By default, the routes learned by Level 1 instances are redistributed by the Level 2 instance. <p>Note The <i>protocol</i> argument must be isis in this configuration of the redistribute command. Only the arguments and keywords relevant to this task are specified here.</p>

Disabling IPv6 Protocol-Support Consistency Checks

This task explains how to disable protocol-support consistency checks in IPv6 single-topology mode.

For single-topology IS-IS IPv6, routers must be configured to run the same set of address families. IS-IS performs consistency checks on hello packets and will reject hello packets that do not have the same set of configured address families. For example, a router running IS-IS for both IPv4 and IPv6 will not form an adjacency with a router running IS-IS for IPv4 or IPv6 only. In order to allow adjacency to be formed in mismatched address-families network, the **adjacency-check** command in IPv6 address family configuration mode must be disabled. This command is designed for use only in special situations. Please read the following note before configuring this task.



Note

Disabling the **adjacency-check** command can adversely affect your network configuration. Enter the **no adjacency-check** command only when you are running IPv4 IS-IS on all your routers and you want to add IPv6 IS-IS to your network but you need to maintain all your adjacencies during the transition. When the IPv6 IS-IS configuration is complete, remove the **no adjacency-check** command from the configuration.

SUMMARY STEPS

1. **enable**
2. **configure terminal**
3. **router isis area-tag**
4. **address-family ipv6 [unicast | multicast]**
5. **no adjacency-check**

DETAILED STEPS

	Command or Action	Purpose
Step 1	enable Example: Router> enable	Enables privileged EXEC mode. <ul style="list-style-type: none"> Enter your password if prompted.
Step 2	configure terminal Example: Router# configure terminal	Enters global configuration mode.
Step 3	router isis area-tag Example: Router(config)# router isis area2	Enables IS-IS for the specified IS-IS routing process, and enters router configuration mode.
Step 4	address-family ipv6 [unicast multicast] Example: Router(config-router)# address-family ipv6	Specifies the IPv6 address family, and enters address family configuration mode. <ul style="list-style-type: none"> The unicast keyword specifies the unicast IPv6 unicast address family. By default, the router is placed in configuration mode for the unicast IPv6 address family if the unicast keyword is not specified with the address-family ipv6 command.
Step 5	no adjacency-check Example: Router(config-router-af)# no adjacency-check	Disables the IPv6 protocol-support consistency checks performed on hello packets, allowing IPv6 to be introduced into an IPv4-only network without disrupting existing adjacencies. <ul style="list-style-type: none"> The adjacency-check command is enabled by default.

Disabling IPv4 Subnet Consistency Checks

This task explains how to disable IPv4 subnet consistency checking when forming adjacencies. Cisco IOS software historically makes checks on hello packets to ensure that the IPv4 address is present and has a consistent subnet with the neighbor from which the hello packets are received. To disable this check, use the **no adjacency-check** command in the router configuration mode. However, if multitopology IS-IS is configured, this check is automatically suppressed, because multitopology IS-IS requires routers to form an adjacency regardless of whether or not all routers on a LAN support a common protocol.

SUMMARY STEPS

1. **enable**
2. **configure terminal**
3. **router isis area-tag**
4. **no adjacency-check**

DETAILED STEPS

	Command or Action	Purpose
Step 1	<code>enable</code> Example: Router> enable	Enables privileged EXEC mode. <ul style="list-style-type: none"> Enter your password if prompted.
Step 2	<code>configure terminal</code> Example: Router# configure terminal	Enters global configuration mode.
Step 3	<code>router isis area-tag</code> Example: Router(config)# router isis area2	Enables IS-IS for the specified IS-IS routing process, and enters router configuration mode.
Step 4	<code>no adjacency-check</code> Example: Router(config-router-af)# no adjacency-check	Disables the IPv6 protocol-support consistency checks performed on hello packets, allowing IPv6 to be introduced into an IPv4-only network without disrupting existing adjacencies. <ul style="list-style-type: none"> The adjacency-check command is enabled by default.

Verifying IPv6 IS-IS Configuration and Operation

This task explains how to display information to verify the configuration and operation of IPv6 IS-IS.

SUMMARY STEPS

- `enable`
- `show ipv6 protocols [summary]`
- `show isis [process-tag] [ipv6 | *] topology`
- `show clns [process-tag] neighbors [interface-type interface-number] [area] [detail]`
- `show clns area-tag is-neighbors [type number] [detail]`
- `show isis [process-tag] database [level-1] [level-2] [l1] [l2] [detail] [lspid]`
- `show isis ipv6 rib [ipv6-prefix]`

DETAILED STEPS

	Command or Action	Purpose
Step 1	enable Example: Router> enable	Enables privileged EXEC mode. <ul style="list-style-type: none"> Enter your password if prompted.
Step 2	show ipv6 protocols [summary] Example: Router# show ipv6 protocols	Displays the parameters and current state of the active IPv6 routing processes.
Step 3	show isis [process-tag] [ipv6 *] topology Example: Router# show isis topology	Displays a list of all connected routers running IS-IS in all areas.
Step 4	show clns [process-tag] neighbors [interface-type interface-number] [area] [detail] Example: Router# show clns neighbors detail	Displays end system (ES), intermediate system (IS), and multitopology IS-IS (M-ISIS) neighbors.
Step 5	show clns area-tag is-neighbors [type number] [detail] Example: Router# show clns is-neighbors detail	Displays IS-IS adjacency information for IS-IS neighbors. <ul style="list-style-type: none"> Use the detail keyword to display the IPv6 link-local addresses of the neighbors.
Step 6	show isis [process-tag] database [level-1] [level-2] [l1] [l2] [detail] [lspid] Example: Router# show isis database detail	Displays the IS-IS link-state database. <ul style="list-style-type: none"> In this example, the contents of each LSP are displayed using the detail keyword.
Step 7	show isis ipv6 rib [ipv6-prefix] Example: Router# show isis ipv6 rib	Displays the IPv6 local RIB.

Troubleshooting Tips

You can use several system debugging commands to check your IS-IS for IPv6 implementation.

If adjacencies are not coming up properly, use the **debug isis adj-packets** command.

If you are using IS-IS multitopology for IPv6 and want to display statistical information about building routes between intermediate systems, use the **debug isis spf-statistics** command.

To display a log of significant events during an IS-IS SPF computation, use the **debug isis spf-events** command.

Examples

This section provides the following output examples:

- [Sample Output for the show ipv6 protocols Command](#)
- [Sample Output for the show isis topology Command](#)
- [Sample Output for the show clns is-neighbors Command](#)
- [Sample Output for the show isis database Command](#)
- [Sample Output for the show isis ipv6 rib Command](#)

Sample Output for the show ipv6 protocols Command

In the following example, output information about the parameters and current state of that active IPv6 routing processes is displayed using the **show ipv6 protocols EXEC** command:

```
Router# show ipv6 protocols

IPv6 Routing Protocol is "connected"
IPv6 Routing Protocol is "static"
IPv6 Routing Protocol is "isis"
  Interfaces:
    Ethernet0/0/3
    Ethernet0/0/1
    Serial1/0/1
    Loopback1 (Passive)
    Loopback2 (Passive)
    Loopback3 (Passive)
    Loopback4 (Passive)
    Loopback5 (Passive)
  Redistribution:
    Redistributing protocol static at level 1
  Address Summarization:
    L2: 2001:0DB8:33::/16 advertised with metric 0
    L2: 2001:0DB8:44::/16 advertised with metric 20
    L2: 2001:0DB8:66::/16 advertised with metric 10
    L2: 2001:0DB8:77::/16 advertised with metric 10
```

Sample Output for the show isis topology Command

In the following example, output information about all connected routers running IS-IS in all areas is displayed using the **show isis topology EXEC** command:

```
Router# show isis topology

IS-IS paths to level-1 routers
System Id      Metric  Next-Hop      Interface      SNPA
0000.0000.000C
0000.0000.000D  20     0000.0000.00AA Se1/0/1        *HDLC*
0000.0000.000F  10     0000.0000.000F Et0/0/1        0050.e2e5.d01d
0000.0000.00AA  10     0000.0000.00AA Se1/0/1        *HDLC*

IS-IS paths to level-2 routers
System Id      Metric  Next-Hop      Interface      SNPA
0000.0000.000A  10     0000.0000.000A Et0/0/3        0010.f68d.f063
0000.0000.000B  20     0000.0000.000A Et0/0/3        0010.f68d.f063
0000.0000.000C  --
0000.0000.000D  30     0000.0000.000A Et0/0/3        0010.f68d.f063
0000.0000.000E  30     0000.0000.000A Et0/0/3        0010.f68d.f063
```

Sample Output for the show clns neighbors Command

In the following example, detailed output information that displays both end system (ES) and intermediate system (IS) neighbors is displayed using the **show clns neighbors** command with the **detail** keyword.

```
Router# show clns neighbors detail

System Id      Interface      SNPA          State  Holdtime  Type  Protocol
0000.0000.0007 Et3/3         aa00.0400.6408 UP     26        L1   IS-IS
Area Address(es): 20
IP Address(es): 172.16.0.42*
Uptime: 00:21:49
0000.0C00.0C35 Et3/2         0000.0c00.0c36 Up     91        L1   IS-IS
Area Address(es): 20
IP Address(es): 192.168.0.42*
Uptime: 00:21:52
0800.2B16.24EA Et3/3         aa00.0400.2d05 Up     27        L1   M-ISIS
Area Address(es): 20
IP Address(es): 192.168.0.42*
IPv6 Address(es): FE80::2B0:8EFF:FE31:EC57
Uptime: 00:00:27
0800.2B14.060E Et3/2         aa00.0400.9205 Up     8         L1   IS-IS
Area Address(es): 20
IP Address(es): 192.168.0.30*
Uptime: 00:21:52
```

Sample Output for the show clns is-neighbors Command

In the following example, output information to confirm that the local router has formed all the necessary IS-IS adjacencies with other IS-IS neighbors is displayed using the **show clns is-neighbors EXEC** command. To display the IPv6 link-local addresses of the neighbors, specify the **detail** keyword.

```
Router# show clns is-neighbors detail

System Id      Interface      State  Type  Priority  Circuit Id      Format
0000.0000.00AA Sel/0/1       Up     L1   0         00              Phase V
Area Address(es): 49.0001
IPv6 Address(es): FE80::YYYY:D37C:C854:5
Uptime: 17:21:38
0000.0000.000F Et0/0/1       Up     L1   64        0000.0000.000C.02 Phase V
Area Address(es): 49.0001
IPv6 Address(es): FE80::XXXX:E2FF:FEE5:D01D
Uptime: 17:21:41
0000.0000.000A Et0/0/3       Up     L2   64        0000.0000.000C.01 Phase V
Area Address(es): 49.000b
IPv6 Address(es): FE80::ZZZZ:F6FF:FE8D:F063
Uptime: 17:22:06
```

Sample Output for the show isis database Command

In the following example, detailed output information about LSPs received from other routers and the IPv6 prefixes they are advertising is displayed using the **show isis database EXEC** command with the **detail** keyword specified:

```
Router# show isis database detail

IS-IS Level-1 Link State Database
LSPID          LSP Seq Num  LSP Checksum  LSP Holdtime  ATT/P/OL
0000.0C00.0C35.00-00 0x0000000C  0x5696        325           0/0/0
```

```

Area Address: 47.0004.004D.0001
Area Address: 39.0001
Metric: 10   IS 0000.0C00.62E6.03
Metric: 0    ES 0000.0C00.0C35
--More--
0000.0C00.40AF.00-00* 0x00000009 0x8452          608          1/0/0
Area Address: 47.0004.004D.0001
Topology: IPv4 (0x0) IPv6 (0x2)
NLPID: 0xCC 0x8E
IP Address: 172.16.21.49
Metric: 10   IS 0800.2B16.24EA.01
Metric: 10   IS 0000.0C00.62E6.03
Metric: 0    ES 0000.0C00.40AF
IPv6 Address: 2001:0DB8::/32
Metric: 10   IPv6 (MT-IPv6) 2001:0DB8::/64
Metric: 5    IS-Extended cisco.03
Metric: 10   IS-Extended cisco1.03
Metric: 10   IS (MT-IPv6) cisco.03

IS-IS Level-2 Link State Database:
LSPID                LSP Seq Num  LSP Checksum  LSP Holdtime  ATT/P/OL
0000.0000.000A.00-00 0x00000059  0x378A        949           0/0/0
Area Address: 49.000b
NLPID:                0x8E
IPv6 Address: 2001:0DB8:1:1:1:1:1:1
Metric: 10            IPv6 2001:0DB8:2:YYYY::/64
Metric: 10            IPv6 2001:0DB8:3:YYYY::/64
Metric: 10            IPv6 2001:0DB8:2:YYYY::/64
Metric: 10            IS-Extended 0000.0000.000A.01
Metric: 10            IS-Extended 0000.0000.000B.00
Metric: 10            IS-Extended 0000.0000.000C.01
Metric: 0             IPv6 11:1:YYYY:1:1:1:1:1/128
Metric: 0             IPv6 11:2:YYYY:1:1:1:1:1/128
Metric: 0             IPv6 11:3:YYYY:1:1:1:1:1/128
Metric: 0             IPv6 11:4:YYYY:1:1:1:1:1/128
Metric: 0             IPv6 11:5:YYYY:1:1:1:1:1/128
0000.0000.000A.01-00 0x00000050  0xB0AF        491           0/0/0
Metric: 0             IS-Extended 0000.0000.000A.00
Metric: 0             IS-Extended 0000.0000.000B.00

```

Sample Output for the show isis ipv6 rib Command

The following example shows output from the **show isis ipv6 rib** command. An asterisk (*) indicates prefixes that have been installed in the master IPv6 RIB as IS-IS routes. Following each prefix is a list of all paths in order of preference, with optimal paths listed first and suboptimal paths listed after optimal paths.

```
Router# show isis ipv6 rib
```

```

IS-IS IPv6 process "", local RIB
2001:0DB8:88:1::/64
  via FE80::210:7BFF:FEC2:ACC9/Ethernet2/0, type L2 metric 20 LSP [3/7]
  via FE80::210:7BFF:FEC2:ACC9/Ethernet2/1, type L2 metric 20 LSP [3/7]
* 2001:0DB8:1357:1::/64
  via FE80::202:7DFF:FE1A:9471/Ethernet2/1, type L2 metric 10 LSP [4/9]
* 2001:0DB8:45A::/64
  via FE80::210:7BFF:FEC2:ACC9/Ethernet2/0, type L1 metric 20 LSP [C/6]
  via FE80::210:7BFF:FEC2:ACC9/Ethernet2/1, type L1 metric 20 LSP [C/6]
  via FE80::210:7BFF:FEC2:ACC9/Ethernet2/0, type L2 metric 20 LSP [3/7]
  via FE80::210:7BFF:FEC2:ACC9/Ethernet2/1, type L2 metric 20 LSP [3/7]

```

Configuration Examples for IPv6 IS-IS

This section provides the following configuration examples:

- [Configuring Single-Topology IS-IS for IPv6 Example, page 253](#)
- [Customizing IPv6 IS-IS Example, page 253](#)
- [Redistributing Routes into an IPv6 IS-IS Routing Process Example, page 253](#)
- [Redistributing IPv6 IS-IS Routes Between IS-IS Levels Example, page 254](#)
- [Disabling IPv6 Protocol-Support Consistency Checks Example, page 254](#)
- [Configuring Multitopology IS-IS for IPv6 Example, page 254](#)
- [Configuring the IS-IS IPv6 Metric for Multitopology IS-IS Example, page 254](#)

Configuring Single-Topology IS-IS for IPv6 Example

The following example enables single-topology mode, creates an IS-IS process, defines the NET, configures an IPv6 address on an interface, and configures the interface to run IPv6 IS-IS:

```
ipv6 unicast-routing
!
router isis
 net 49.0001.0000.0000.000c.00
 exit
interface Ethernet0/0/1
 ipv6 address 2001:0DB8::3/64
 ipv6 router isis area2
```

Customizing IPv6 IS-IS Example

The following example advertises the IPv6 default route (::/0)—with an origin of Ethernet interface 0/0/1—with all other routes in router updates sent on Ethernet interface 0/0/1. This example also sets an administrative distance for IPv6 IS-IS to 90, defines the maximum number of equal-cost paths that IPv6 IS-IS will support as 3, and configures a summary prefix of 2001:0DB8::/24 for IPv6 IS-IS.

```
router isis
 address-family ipv6
 default-information originate
 distance 90
 maximum-paths 3
 summary-prefix 2001:0DB8::/24
 exit
```

Redistributing Routes into an IPv6 IS-IS Routing Process Example

The following example redistributes IPv6 BGP routes into the IPv6 IS-IS Level 2 routing process:

```
router isis
 address-family ipv6
 redistribute bgp 64500 metric 100 route-map isismap
 exit
```

Redistributing IPv6 IS-IS Routes Between IS-IS Levels Example

The following example redistributes IPv6 IS-IS Level 1 routes into the IPv6 IS-IS Level 2 routing process:

```
router isis
 address-family ipv6
 redistribute isis level-1 into level-2
 exit
```

Disabling IPv6 Protocol-Support Consistency Checks Example

The following example disables the **adjacency-check** command to allow a network administrator to configure IPv6 IS-IS on the router without disrupting the existing adjacencies:

```
router isis
 address-family ipv6
 no adjacency-check
 exit
```

Configuring Multitopology IS-IS for IPv6 Example

The following example configures multitopology IS-IS in IPv6 after you have configured IS-IS for IPv6:

```
router isis
 metric-style wide
 address-family ipv6
 multi-topology
 exit
```

Configuring the IS-IS IPv6 Metric for Multitopology IS-IS Example

The following example sets the value of an IS-IS IPv6 metric to 20:

```
interface Ethernet 0/0/1
 isis ipv6 metric 20
```

Where to Go Next

If you want to implement more IPv6 routing protocols, refer to the *Implementing RIP for IPv6* or *Implementing Multiprotocol BGP for IPv6* module.

Additional References

For additional information related to Implementing IS-IS for IPv6, see the following sections.

Related Documents

Related Topic	Document Title
IS-IS configuration tasks	“Configuring Integrated IS-IS” chapter in the <i>Cisco IOS IP Configuration Guide</i> , Release 12.4
IS-IS commands: complete command syntax, command mode, defaults, usage guidelines, and examples	<i>Cisco IOS IP Command Reference, Volume 2 of 3: Routing Protocols</i> , Release 12.4
IPv6 supported feature list	<i>Start Here: Cisco IOS Software Release Specifics for IPv6 Features</i>
IPv6 commands: complete command syntax, command mode, defaults, usage guidelines, and examples	<i>IPv6 for Cisco IOS Command Reference</i>
IPv4 configuration and command reference information	<i>Cisco IOS Release 12.4 Configuration Guides and Command References</i>

Standards

Standards	Title
Draft-ietf-isis-ipv6.txt	<i>Routing IPv6 with IS-IS</i> , October 31, 2002
Draft-ietf-isis-wg-multi-topology.txt	<i>M-ISIS: Multi-Topology (MT) Routing in IS-IS</i> , October 2, 2002

MIBs

MIBs	MIBs Link
<ul style="list-style-type: none"> CISCO-IETF-IP-FORWARD-MIB CISCO-IETF-IP-MIB 	To locate and download MIBs for selected platforms, Cisco IOS releases, and feature sets, use Cisco MIB Locator found at the following URL: http://www.cisco.com/go/mibs

RFCs

RFCs	Title
RFC 1195	<i>Use of OSI IS-IS for Routing in TCP/IP and Dual Environments</i>

Technical Assistance

Description	Link
The Cisco Technical Support website contains thousands of pages of searchable technical content, including links to products, technologies, solutions, technical tips, and tools. Registered Cisco.com users can log in from this page to access even more content.	http://www.cisco.com/techsupport



Managing Cisco IOS Applications over IPv6

This document describes the concepts and commands used to enable access to an IPv6 router. The **copy**, **ping**, **telnet**, and **traceroute** commands have been modified in the Cisco IOS Release 12.2(13)T to provide IPv6 management capability. Secure Shell (SSH) has been enhanced to provide support for IPv6 addresses that enable a Cisco router to accept and establish secure, encrypted connections with remote IPv6 nodes over an IPv6 transport.

Finding Support Information for Platforms and Cisco IOS Software Images

Use Cisco Feature Navigator to find information about platform support and Cisco IOS software image support. Access Cisco Feature Navigator at <http://www.cisco.com/go/fn>. You must have an account on Cisco.com. If you do not have an account or have forgotten your username or password, click **Cancel** at the login dialog box and follow the instructions that appear.

Contents

- [Prerequisites for Managing Cisco IOS Applications over IPv6, page 257](#)
- [Information About Managing Cisco IOS Applications over IPv6, page 258](#)
- [How to Manage Cisco IOS Applications over IPv6, page 260](#)
- [Configuration Examples for Managing Cisco IOS Applications over IPv6, page 266](#)
- [Where to Go Next, page 269](#)
- [Additional References, page 269](#)

Prerequisites for Managing Cisco IOS Applications over IPv6

- This document assumes that you are familiar with IPv4. Refer to the publications referenced in the [“Additional References”](#) section for IPv4 configuration and command reference information.
- By default, IPv6 routing is disabled in the Cisco IOS software. To enable IPv6 routing, you must first enable the forwarding of IPv6 traffic globally on the router and then you must assign IPv6 addresses to individual interfaces in the router. At least one interface must have IPv6 configured.
- To enable Telnet access to a router, you must create a vty interface and password.



Caution Table 18 identifies the earliest release for each early-deployment train in which the feature became available.

Table 18 Minimum Required Cisco IOS Release

Feature	Minimum Required Cisco IOS Release by Release Train
Telnet Access over IPv6	12.0(21)ST, 12.0(22)S, 12.2(2)T, 12.2(14)S, 12.3, 12.3(2)T, 12.4, 12.4(2)T, 12.2(28)SB
TFTP File Downloading, ping, and traceroute Commands for IPv6	12.0(21)ST, 12.0(22)S, 12.2(2)T, 12.2(14)S, 12.3, 12.3(2)T, 12.4, 12.4(2)T, 12.2(28)SB
SSH over an IPv6 Transport	12.0(22)S, 12.2(8)T, 12.2(14)S, 12.3, 12.3(2)T, 12.4, 12.4(2)T, 12.2(28)SB, 12.2(33)SRA
SNMP over an IPv6 Transport	12.0(27)S, 12.3(14)T, 12.4, 12.4(2)T

Information About Managing Cisco IOS Applications over IPv6

To manage Cisco IOS applications over IPv6, you must understand the following concepts:

- [Telnet Access over IPv6, page 258](#)
- [TFTP File Downloading, ping, and traceroute Commands for IPv6, page 258](#)
- [SSH over an IPv6 Transport, page 259](#)
- [SNMP over an IPv6 Transport, page 259](#)

Telnet Access over IPv6

The Telnet client and server in the Cisco IOS software support IPv6 connections. A user can establish a Telnet session directly to the router using an IPv6 Telnet client, or an IPv6 Telnet connection can be initiated from the router. A vty interface and password must be created in order to enable Telnet access to an IPv6 router.

TFTP File Downloading, ping, and traceroute Commands for IPv6

IPv6 supports TFTP file downloading and uploading using the **copy EXEC** command. The **copy EXEC** command accepts a destination IPv6 address or IPv6 host name as an argument and saves the running configuration of the router to an IPv6 TFTP server, as follows:

```
Router# copy running-config tftp://[3ffe:xxxx:c18:1:290:27ff:fe3a:9e9a]/running-config
```



Note

In Cisco IOS Release 12.2(8)T or later releases, a literal IPv6 address specified with a port number must be enclosed in square brackets ([]) when the address is used in TFTP source or destination URLs; a literal IPv6 address specified without a port number need not be enclosed in square brackets. Refer to RFC 2732, *Format for Literal IPv6 Addresses in URLs*, for more information on the use of square brackets with literal IPv6 address in URLs.

The **ping** EXEC command accepts a destination IPv6 address or IPv6 host name as an argument and sends Internet Control Message Protocol version 6 (ICMPv6) echo request messages to the specified destination. The ICMPv6 echo reply messages are reported on the console. Extended ping functionality is also supported in IPv6.

The **tracert** EXEC command accepts a destination IPv6 address or IPv6 host name as an argument and will generate IPv6 traffic to report each IPv6 hop used to reach the destination address.

Refer to the *IPv6 for Cisco IOS Command Reference* document for information on IPv6 modifications to the **copy**, **ping**, **telnet**, and **tracert** commands. These commands also appear in the *Cisco IOS Configuration Fundamentals Command Reference*. Refer to the *Start Here: Cisco IOS Software Release Specifics for IPv6 Features* document on Cisco.com for Cisco IOS software release specifics for supported IPv6 features.

SSH over an IPv6 Transport

In Cisco IOS Release 12.2(8)T or later releases or Cisco IOS Release 12.0(22)S or later releases, SSH in IPv6 functions the same and offers the same benefits as SSH in IPv4—the SSH Server feature enables an SSH client to make a secure, encrypted connection to a Cisco router and the SSH Client feature enables a Cisco router to make a secure, encrypted connection to another Cisco router or to any other device running an SSH server. IPv6 enhancements to SSH consist of support for IPv6 addresses that enable a Cisco router to accept and establish secure, encrypted connections with remote IPv6 nodes over an IPv6 transport.

The SSH over an IPv6 Transport feature has no specific configuration tasks. The **ssh** EXEC command can be used to start an encrypted session with a remote IPv4 or IPv6 networking device. After the SSH server is enabled using the **ip ssh** global configuration command, inbound IPv4 and IPv6 connections can be made to the local router.



Note

The SSH client runs in user EXEC mode and has no specific configuration tasks or commands.

On Cisco.com, refer to the “Configuring Secure Shell” chapter in the *Cisco IOS Security Configuration Guide* for additional SSH configuration information. Refer to the “Secure Shell Commands” chapter in the *Cisco IOS Security Command Reference* for additional SSH command information.

SNMP over an IPv6 Transport

Simple Network Management Protocol (SNMP) can be configured over IPv6 transport so that an IPv6 host can perform SNMP queries and receive SNMP notifications from a device running Cisco IOS IPv6. The SNMP agent and related MIBs have been enhanced to support IPv6 addressing.

The following MIBs are supported for IPv6:

- CISCO-CONFIG-COPY-MIB
- CISCO-CONFIG-MAN-MIB
- CISCO-DATA-COLLECTION-MIB
- CISCO-FLASH-MIB
- ENTITY-MIB
- NOTIFICATION-LOG-MIB
- SNMP-TARGET-MIB

CISCO-CONFIG-COPY-MIB and CISCO-FLASH-MIB support IPv6 addressing when either TFTP, remote copy protocol (rcp), or FTP is used.

The following MIB has been added for the IPv6 over SNMP support feature:

- CISCO-SNMP-TARGET-EXT-MIB

The following MIBs have been modified for the IPv6 over SNMP support feature:

- CISCO-FLASH-MIB
- CISCO-CONFIG-MAN-MIB
- CISCO-CONFIG-COPY-MIB

Refer to *Cisco IOS Configuration Fundamentals Configuration Guide* for detailed information about SNMP, MIBs, and managing Cisco networks in Cisco IOS software.

How to Manage Cisco IOS Applications over IPv6

This section contains the following procedures:

- [Enabling Telnet Access to an IPv6 Router and Establishing a Telnet Session, page 260](#) (Optional)
- [Enabling SSH on an IPv6 Router, page 262](#) (Optional)
- [Disabling HTTP Access to an IPv6 Router, page 264](#) (Optional)
- [Configuring an SNMP Notification Server over IPv6, page 264](#) (Optional)

Enabling Telnet Access to an IPv6 Router and Establishing a Telnet Session

This task describes how to enable Telnet access to an IPv6 router and establish a Telnet session. Using either IPv4 or IPv6 transport, you can use Telnet to connect from a host to a router, from a router to a router, and from a router to a host.

Refer to the *Implementing Basic Connectivity for IPv6* module for information on IPv6 addressing and enabling IPv6 routing. Refer to the *Cisco IOS Security Command Reference*, Release 12.4, for information on password configuration.

SUMMARY STEPS

1. **enable**
2. **configure terminal**
3. **ipv6 host name [port] ipv6-address1 [ipv6-address2...ipv6-address4]**
4. **line [aux | console | tty | vty] line-number [ending-line-number]**
5. **password password**
6. **login [local | tacacs]**
7. **ipv6 access-class ipv6-access-list-name {in | out}**
8. **telnet host [port] [keyword]**

DETAILED STEPS

	Command or Action	Purpose
Step 1	<p>enable</p> <p>Example: Router> enable</p>	<p>Enables privileged EXEC mode.</p> <ul style="list-style-type: none"> Enter your password if prompted.
Step 2	<p>configure terminal</p> <p>Example: Router# configure terminal</p>	<p>Enters global configuration mode.</p>
Step 3	<p>ipv6 host name [port] ipv6-address1 [ipv6-address2...ipv6-address4]</p> <p>Example: Router(config)# ipv6 host cisco-sj 2001:0DB8:20:1::12</p>	<p>Defines a static host name-to-address mapping in the host name cache.</p>
Step 4	<p>line [aux console tty vty] line-number [ending-line-number]</p> <p>Example: Router(config)# line vty 0 4</p>	<p>Works with the vty keyword to create a vty interface.</p>
Step 5	<p>password password</p> <p>Example: Router(config)# password hostword</p>	<p>Creates a password that enables Telnet.</p>
Step 6	<p>login [local tacacs]</p> <p>Example: Router(config)# login tacacs</p>	<p>(Optional) Enables password checking at login.</p>
Step 7	<p>ipv6 access-class ipv6-access-list-name {in out}</p> <p>Example: Router(config)# ipv6 access-list hostlist</p>	<p>(Optional) Adds an IPv6 access list to the line interface.</p> <ul style="list-style-type: none"> Using this command restricts remote access to sessions that match the access list.
Step 8	<p>telnet host [port] [keyword]</p> <p>Example: Router(config)# telnet cisco-sj</p>	<p>Establishes a Telnet session from a router to a remote host using either the host name or the IPv6 address.</p> <p>The Telnet session can be established to a router name or to an IPv6 address.</p>

What to Do Next

Proceed to the [“Configuration Examples for Managing Cisco IOS Applications over IPv6”](#) section.

Enabling SSH on an IPv6 Router

This task describes how to enable SSH for use over an IPv6 transport. If you do not configure SSH parameters, then the default values will be used.

Prerequisites

Prior to configuring SSH over an IPv6 transport, ensure that the following conditions exist:

- An IPsec (Data Encryption Standard (DES) or 3DES) encryption software image from Cisco IOS Release 12.2(8)T or later releases or Cisco IOS Release 12.0(22)S or later releases is loaded on your router. IPv6 transport for the SSH server and SSH client requires an IPsec encryption software image. Refer to the “Loading and Maintaining System Images” chapter of *Cisco IOS Configuration Fundamentals Configuration Guide*, Release 12.4, for information on downloading a software image to your router.
- A host name and host domain are configured for your router. Refer to the “Mapping Host Names to IPv6 Addresses” section of the *Implementing Basic Connectivity for IPv6* module for information on assigning host names to IPv6 addresses and specifying default domain names that can be used by both IPv4 and IPv6.
- A Rivest, Shamir, and Adelman (RSA) key pair, which automatically enables SSH, is generated for your router. Refer to the “Configuring Certification Authority Interoperability” chapter of *Cisco IOS Security Configuration Guide*, Release 12.4, for information on generating an RSA key pair.



Note

RSA is the public key cryptographic system developed by Ron Rivest, Adi Shamir, and Leonard Adelman. RSA keys come in pairs: one public key and one private key.

- A user authentication mechanism for local or remote access is configured on your router. Refer to the “Restrictions” section of the *Start Here: Cisco IOS Software Release Specifics for IPv6 Features* document for authentication mechanism restrictions for SSH over an IPv6 transport.

Restrictions

The basic restrictions for SSH over an IPv4 transport listed in the “Configuring Secure Shell” chapter of *Cisco IOS Security Configuration Guide*, Release 12.4, apply to SSH over an IPv6 transport. In addition to the restrictions listed in that chapter, the use of locally stored usernames and passwords is the only user authentication mechanism supported by SSH over an IPv6 transport; the TACACS+ and RADIUS user authentication mechanisms are not supported over an IPv6 transport.



Note

To authenticate SSH clients, configure TACACS+ or RADIUS over an IPv4 transport and then connect to an SSH server over an IPv6 transport.

SUMMARY STEPS

1. **enable**
2. **configure terminal**
3. **ip ssh [timeout *seconds* | authentication-retries *integer*]**
4. **exit**

5. `ssh [-v {1 | 2}] [-c {3des | aes128-cbc | aes192-cbc | aes256-cbc}] [-l userid | -l userid:{number} {ip-address} | -l userid:rotary{number} {ip-address}] [-m {hmac-md5 | hmac-md5-96 | hmac-sha1 | hmac-sha1-96}] [-o numberofpasswordprompts n] [-p port-num] {ip-addr | hostname} [command]`

DETAILED STEPS

	Command or Action	Purpose
Step 1	<p><code>enable</code></p> <p>Example: Router> enable</p>	<p>Enables privileged EXEC mode.</p> <ul style="list-style-type: none"> Enter your password if prompted.
Step 2	<p><code>configure terminal</code></p> <p>Example: Router# configure terminal</p>	<p>Enters global configuration mode.</p>
Step 3	<p><code>ip ssh [timeout seconds authentication-retries integer]</code></p> <p>Example: Router(config)# ip ssh timeout 100 authentication-retries 2</p>	<p>Configures SSH control variables on your router.</p> <ul style="list-style-type: none"> You can specify the timeout in seconds, not to exceed 120 seconds. The default is 120. This setting applies to the SSH negotiation phase. Once the EXEC session starts, the standard timeouts configured for the vty apply. By default, five vty lines are defined (0–4); therefore, five terminal sessions are possible. After the SSH executes a shell, the vty timeout starts. The vty timeout defaults to 10 minutes. You can also specify the number of authentication retries, not to exceed five authentication retries. The default is three.
Step 4	<p><code>exit</code></p> <p>Example: Router(config)# exit</p>	<p>Exits configuration mode, and returns the router to privileged EXEC mode.</p>
Step 5	<p><code>ssh [-v {1 2}] [-c {3des aes128-cbc aes192-cbc aes256-cbc}] [-l userid -l userid:{number} {ip-address} -l userid:rotary{number} {ip-address}] [-m {hmac-md5 hmac-md5-96 hmac-sha1 hmac-sha1-96}] [-o numberofpasswordprompts n] [-p port-num] {ip-addr hostname} [command]</code></p> <p>Example: Router# ssh</p>	<p>Starts an encrypted session with a remote networking device.</p>

What to Do Next

Proceed to the “[Configuration Examples for Managing Cisco IOS Applications over IPv6](#)” section.

Disabling HTTP Access to an IPv6 Router

HTTP access over IPv6 is automatically enabled if an HTTP server is enabled and the router has an IPv6 address. If the HTTP server is not required, it should be disabled as described in this section.

SUMMARY STEPS

1. **enable**
2. **configure terminal**
3. **no ip http server**

DETAILED STEPS

	Command or Action	Purpose
Step 1	enable Example: Router> enable	Enables privileged EXEC mode. <ul style="list-style-type: none"> • Enter your password if prompted.
Step 2	configure terminal Example: Router# configure terminal	Enters global configuration mode.
Step 3	no ip http server Example: Router(config)# no ip http server	Disables HTTP access.

What to Do Next

Proceed to the [“Configuration Examples for Managing Cisco IOS Applications over IPv6”](#) section.

Configuring an SNMP Notification Server over IPv6

Use an SNMP community string to define the relationship between the SNMP manager and the agent. The community string acts like a password to regulate access to the agent on the router. Optionally, you can specify one or more of the following characteristics associated with the string:

- An access list of IP addresses of the SNMP managers that are permitted to use the community string to gain access to the agent.
- A MIB view, which defines the subset of all MIB objects accessible to the given community.
- Read and write or read-only permission for the MIB objects accessible to the community.

You can configure one or more community strings. To remove a specific community string, use the **no snmp-server community** command.

The **snmp-server host** command specifies which hosts will receive SNMP notifications, and whether you want the notifications sent as traps or inform requests. The **snmp-server enable traps** command globally enables the production mechanism for the specified notification types (such as Border Gateway Protocol [BGP] traps, config traps, entity traps, and Hot Standby Router Protocol [HSRP] traps).

SUMMARY STEPS

1. **enable**
2. **configure terminal**
3. **snmp-server community** *string* [**view** *view-name*] [**ro** | **rw**] [**ipv6 nacl**] [*access-list-number*]
4. **snmp-server engineID remote** {*ipv4-ip-address* | *ipv6 address*} [**udp-port** *udp-port-number*] [**vrf** *vrf-name*] *engineid-string*
5. **snmp-server group** *group-name* {**v1** | **v2c** | **v3** {**auth** | **noauth** | **priv**}} [**context** *context-name*] [**read** *read-view*] [**write** *write-view*] [**notify** *notify-view*] [**access** [**ipv6** *named-access-list*]{*acl-number* | *acl-name*}]
6. **snmp-server host** {*hostname* | *ip-address*} [**vrf** *vrf-name*] [**traps** | **informs**] [**version** {**1** | **2c** | **3** [**auth** | **noauth** | **priv**]}] *community-string* [**udp-port** *port*] [*notification-type*]
7. **snmp-server user** *username* *group-name* [**remote** *host* [**udp-port** *port*]] {**v1** | **v2c** | **v3** [**encrypted**] [**auth** {**md5** | **sha**} *auth-password*]} [**access** [**ipv6 nacl**] [**priv** {**des** | **3des** | **aes** {**128** | **192** | **256**}} *privpassword*] {*acl-number* | *acl-name*}]
8. **snmp-server enable traps** [*notification-type*] [**vrrp**]

DETAILED STEPS

	Command or Action	Purpose
Step 1	enable Example: Router> enable	Enables privileged EXEC mode. <ul style="list-style-type: none">• Enter your password if prompted.
Step 2	configure terminal Example: Router# configure terminal	Enters global configuration mode.
Step 3	snmp-server community <i>string</i> [view <i>view-name</i>] [ro rw] [ipv6 nacl] [<i>access-list-number</i>] Example: Router(config)# snmp-server community mgr view restricted rw ipv6 mgr2	Defines the community access string.
Step 4	snmp-server engineID remote { <i>ipv4-ip-address</i> <i>ipv6-address</i> } [udp-port <i>udp-port-number</i>] [vrf <i>vrf-name</i>] <i>engineid-string</i> Example: Router(config)# snmp-server engineID remote 3ffe:b00:c18:1::3/127 remotev6	(Optional) Specifies the name of the remote SNMP engine (or copy of SNMP).

	Command or Action	Purpose
Step 5	<pre>snmp-server group group-name {v1 v2c v3 {auth noauth priv}} [context context-name] [read read-view] [write write-view] [notify notify-view] [access [ipv6 named-access-list]{acl-number acl-name}]</pre> <p>Example: Router(config)# snmp-server group public v2c access ipv6 public2</p>	(Optional) Configures a new SNMP group, or a table that maps SNMP users to SNMP views.
Step 6	<pre>snmp-server host {hostname ip-address} [vrf vrf-name] [traps informs] [version {1 2c 3 [auth noauth priv]] community-string [udp-port port] [notification-type]</pre> <p>Example: Router(config)# snmp-server host host1.com 2c vrf trap-vrf</p>	Specifies the recipient of an SNMP notification operation. Specifies whether you want the SNMP notifications sent as traps or informs, the version of SNMP to use, the security level of the notifications (for SNMPv3), and the recipient (host) of the notifications.
Step 7	<pre>snmp-server user username group-name [remote host [udp-port port]] {v1 v2c v3 [encrypted] [auth {md5 sha} auth-password]} [access [ipv6 nacl] [priv {des 3des aes {128 192 256}}] privpassword] {acl-number acl-name}]</pre> <p>Example: Router(config)# snmp-server user user1 bldg1 remote 3ffe:b00:c18:1::3/127 v2c access ipv6 public2</p>	(Optional) Configures a new user to an existing SNMP group. Note You cannot configure a remote user for an address without first configuring the engine ID for that remote host. This is a restriction imposed in the design of these commands; if you try to configure the user before the host, you will receive a warning message and the command will not be executed
Step 8	<pre>snmp-server enable traps [notification-type] [vrrp]</pre> <p>Example: Router(config)# snmp-server enable traps bgp</p>	Enables sending of traps or informs, and specifies the type of notifications to be sent. <ul style="list-style-type: none"> • If a <i>notification-type</i> is not specified, all supported notification will be enabled on the router. • To discover which notifications are available on your router, enter the snmp-server enable traps ? command.

What to Do Next

Refer to the *Cisco IOS Configuration Fundamentals Configuration Guide* for more information about SNMP and MIBs.

Configuration Examples for Managing Cisco IOS Applications over IPv6

This section provides the following configuration examples:

- [Enabling Telnet Access to an IPv6 Router Configuration: Examples, page 267](#)
- [Disabling HTTP Access to an IPv6 Router, page 264](#)

- [Configuring an SNMP Notification Server: Examples, page 268](#)

Enabling Telnet Access to an IPv6 Router Configuration: Examples

The following examples provide information on how to enable Telnet and start a session to or from an IPv6 router. In the following example, the IPv6 address is specified as 2001:0db8:20:1::12, and the host name is specified as cisco-sj. The **show host** command is used to verify this information.

```
Router# configure terminal
Router(config)# ipv6 host cisco-sj 2001:0db8:20:1::12
ed2-36c(config)# end
Router# show host

Default domain is not set
Name/address lookup uses static mappings

Codes:UN - unknown, EX - expired, OK - OK, ?? - revalidate
       temp - temporary, perm - permanent
       NA - Not Applicable None - Not defined

Host                Port  Flags      Age Type  Address(es)
cisco-sj            None  (perm, OK)  0  IPv6  2001:0db8:20:1::12
```

To enable Telnet access to a router, create a vty interface and password:

```
Router(config)# line vty 0 4

password lab
login
```

To use Telnet to access the router, you must enter the password:

```
Router# telnet cisco-sj

Trying cisco-sj (2001:0db8:20:1::12)... Open

User Access Verification

Password:
cisco-sj
.
.
.
verification
```

It is not necessary to use the **telnet** command. Specifying either the host name or the address is sufficient, as shown in the following examples:

```
Router# cisco-sj

or

Router# 2001:0db8:20:1::12
```

To display the IPv6 connected user (line 130) on the router to which you are connected, use the **show users** command:

```
Router# show users

      Line      User      Host(s)      Idle      Location
*    0 con 0          idle          00:00:00
  130 vty 0          idle          00:00:22   8800::3
```

Note that the address displayed is the IPv6 address of the source of the connection. If the host name of the source is known (either through a domain name server (DNS) or locally in the host cache), then it is displayed instead:

```
Router# show users
```

Line	User	Host(s)	Idle	Location
* 0 con 0		idle	00:00:00	
130 vty 0		idle	00:02:47	cisco-sj

If the user at the connecting router suspends the session with ^6x and then enters the **show sessions** command, the IPv6 connection is displayed:

```
Router# show sessions
```

Conn	Host	Address	Byte	Idle	Conn	Name
* 1	cisco-sj	2001:0db8:20:1::12	0	0	cisco-sj	

The Conn Name field shows the host name of the destination only if it is known. If it is not known, the output might look similar to the following:

```
Router# show sessions
```

Conn	Host	Address	Byte	Idle	Conn	Name
* 1	2001:0db8:20:1::12	2001:0db8:20:1::12	0	0	2001:0db8:20:1::12	

Disabling HTTP Access to the Router: Example

In the following example, the **show running-config** privileged EXEC command is used to show that HTTP access is disabled on the router:

```
Router# show running-config
```

```
Building configuration...
!
Current configuration : 1490 bytes
!
version 12.2
!
hostname Router
!
no ip http server
!
line con 0
line aux 0
line vty 0 4
```

Configuring an SNMP Notification Server: Examples

The following example permits any SNMP to access all objects with read-only permission using the community string named public. The router also will send BGP traps to the IPv4 host 172.16.1.111 and IPv6 host 3ffe:b00:c18:1::3/127 using SNMPv1 and to the host 172.16.1.27 using SNMPv2c. The community string named public is sent with the traps.

```
Router(config)# snmp-server community public
Router(config)# snmp-server enable traps bgp
Router(config)# snmp-server host 172.16.1.27 version 2c public
Router(config)# snmp-server host 172.16.1.111 version 1 public
```

```
Router(config)# snmp-server host 3ffe:b00:c18:1::3/127 public
```

Associate an SNMP Server Group with Specified Views Example

In the following example, the SNMP context A is associated with the views in SNMPv2c group GROUP1 and the IPv6 named access list public2:

```
Router(config)# snmp-server context A
Router(config)# snmp mib community-map commA context A target-list commAVpn
Router(config)# snmp mib target list commAVpn vrf Customer_A
Router(config)# snmp-server view viewA ciscoPingMIB included
Router(config)# snmp-server view viewA ipForward included
Router(config)# snmp-server group GROUP1 v2c context A read viewA write viewA notify
access ipv6 public2
```

Create an SNMP Notification Server Example

The following example configures the IPv6 host as the notification server:

```
Router> enable
Router# configure terminal
Router(config)# snmp-server community mgr view restricted rw ipv6 mgr2
Router(config)# snmp-server engineID remote 3ffe:b00:c18:1::3/127 remotev6
Router(config)# snmp-server group public v2c access ipv6 public2
Router(cofig)# snmp-server host host1.com 2c vrf trap-vrf
Router(cofig)# snmp-server user user1 bldg1 remote 3ffe:b00:c18:1::3/127 v2c access ipv6
public2
Router(config)# snmp-server enable traps bgp
Router(config)# exit
```

Where to Go Next

To implement IPv6 routing protocols, refer to the *Implementing RIP for IPv6*, *Implementing IS-IS for IPv6*, or *Implementing Multiprotocol BGP for IPv6* module.

Additional References

For additional information related to managing Cisco IOS applications over IPv6, see the following sections.

Related Documents

Related Topic	Document Title
tftp, ping, telnet, and traceroute command information	<i>Cisco IOS Configuration Fundamentals Command Reference</i> , Release 12.4 <i>Cisco IOS Terminal Service Command Reference</i> , Release 12.4
SSH configuration information	<i>Cisco IOS Security Command Reference</i> , Release 12.4
IPv6 supported features	<i>Start Here: Cisco IOS Software Release Specifics for IPv6 Features</i>
Basic IPv6 configuration tasks	<i>Implementing Basic Connectivity for IPv6</i>

Related Topic	Document Title
IPv6 commands: complete command syntax, command mode, defaults, usage guidelines, and examples	<i>IPv6 for Cisco IOS Command Reference</i>
IPv4 configuration and command reference information	<i>Cisco IOS Release 12.4 Configuration Guides and Command References</i>

Standards

Standards	Title
No new or modified standards are supported by this feature, and support for existing standards has not been modified by this feature.	—

MIBs

MIBs	MIBs Link
<ul style="list-style-type: none"> • CISCO-CONFIG-COPY-MIB • CISCO-DATA-COLLECTION-MIB • CISCO-FLASH-MIB • ENTITY-MIB • NOTIFICATION-LOG-MIB • SNMP-TARGET-MIB • CISCO-SNMP-TARGET-EXT-MIB 	<p>To locate and download MIBs for selected platforms, Cisco IOS releases, and feature sets, use Cisco MIB Locator found at the following URL:</p> <p>http://www.cisco.com/go/mibs</p>

RFCs

RFCs	Title
RFC 2732	<i>Format for Literal IPv6 Addresses in URLs</i>

Technical Assistance

Description	Link
The Cisco Technical Support website contains thousands of pages of searchable technical content, including links to products, technologies, solutions, technical tips, and tools. Registered Cisco.com users can log in from this page to access even more content.	http://www.cisco.com/techsupport



Implementing Mobile IPv6

Mobile IP is part of both IPv4 and IPv6 standards. Mobile IP allows a host device to be identified by a single IP address even though the device may move its physical point of attachment from one network to another. Regardless of movement between different networks, connectivity at the different points is achieved seamlessly without user intervention. Roaming from a wired network to a wireless or wide-area network is also done with ease. Mobile IP provides ubiquitous connectivity for users, whether they are within their enterprise networks or away from home.

Finding Support Information for Platforms and Cisco IOS Software Images

Use Cisco Feature Navigator to find information about platform support and Cisco IOS software image support. Access Cisco Feature Navigator at <http://www.cisco.com/go/fn>. You must have an account on Cisco.com. If you do not have an account or have forgotten your username or password, click **Cancel** at the login dialog box and follow the instructions that appear.

Contents

- [Prerequisites for Implementing Mobile IPv6, page 271](#)
- [Restrictions for Mobile IPv6, page 272](#)
- [Information About Mobile IPv6, page 272](#)
- [How to Implement Mobile IPv6, page 275](#)
- [Configuration Examples for Mobile IPv6, page 284](#)
- [Additional References, page 285](#)

Prerequisites for Implementing Mobile IPv6

This document assumes that you are familiar with IPv4. Refer to the publications referenced in the “[Additional References](#)” section for IPv4 configuration and command reference information.

[Table 19](#) identifies the earliest release for each early-deployment train in which each feature became available.

Table 19 Minimum Required Cisco IOS Release

Feature	Minimum Required Cisco IOS Release by Release Train
Mobile IPv6 home agent	12.3(14)T, 12.4, 12.4(2)T
IPv6 ACL enhancements	12.4(2)T

Restrictions for Mobile IPv6

RFC 3776, *Using IPSec to Protect Mobile IPv6 Signaling Between Mobile Nodes and Home Agents*, is not supported in the current Cisco IOS Release.

Information About Mobile IPv6

To configure Mobile IPv6 for Cisco IOS, you must understand the following concepts:

- [Mobile IPv6 Overview, page 272](#)
- [How Mobile IPv6 Works, page 274](#)
- [Packet Headers in Mobile IPv6, page 274](#)
- [IPv6 Neighbor Discovery with Mobile IPv6, page 274](#)

Mobile IPv6 Overview

Before you configure Mobile IPv6, you should understand the following concepts:

- [Mobile IPv6 Benefits, page 272](#)
- [Mobile IPv6 Home Agent, page 273](#)
- [Binding Cache in Mobile IPv6 Home Agent, page 273](#)
- [Binding Update List in Mobile IPv6 Home Agent, page 273](#)
- [Home Agents List, page 273](#)

Mobile IPv6 Benefits

Mobile IP provides an IP node with the ability to retain the same IP address and maintain uninterrupted network and application connectivity while traveling across networks. In Mobile IPv6, the IPv6 address space enables Mobile IP deployment in any kind of large environment. No foreign agent is needed to use Mobile IPv6.

System infrastructures do not need an upgrade to accept Mobile IPv6 nodes. IPv6 autoconfiguration simplifies mobile node Care of Address (CoA) assignment.

Mobile IPv6 benefits from the IPv6 protocol itself; for example, Mobile IPv6 uses IPv6 option headers (routing, destination, and mobility) and benefits from the use of neighbor discovery.

Mobile IPv6 provides optimized routing, which helps avoid triangular routing. Mobile IPv6 nodes work transparently even with nodes that do not support mobility (although these nodes do not have route optimization).

Mobile IPv6 is fully backward-compatible with existing IPv6 specifications. Therefore, any existing host that does not understand the new mobile messages will send an existing error message, and communications with the mobile node will be able to continue, albeit without the direct routing optimization.

Mobile IPv6 Home Agent

The home agent is one of three key components in Mobile IPv6. The home agent works with the correspondent node and mobile node to enable Mobile IPv6 functionality.

- Home agent—Maintains an association between the mobile node's home IP or IPv6 address and its CoA (loaned address) on the foreign network.
- Correspondent node—Destination IP or IPv6 host in session with a mobile node.
- Mobile node—An IP or IPv6 host that maintains network connectivity using its home IP or IPv6 address, regardless of the link (or network) to which it is connected.

Binding Cache in Mobile IPv6 Home Agent

A separate binding cache is maintained by each IPv6 node for each of its IPv6 addresses. When the router sends a packet, it searches the binding cache for an IPv6 address before it searches the neighbor discovery conceptual destination cache.

The binding cache for any one of a node's IPv6 addresses may contain one entry for each mobile node home address. The contents of all of a node's binding cache entries are cleared when it reboots.

Binding cache entries are marked either as home registration or correspondent registration entries. A home registration entry is deleted when its binding lifetime expires; other entries may be replaced at any time through a local cache replacement policy.

Binding Update List in Mobile IPv6 Home Agent

A binding update list is maintained by each mobile node. The binding update list records information for each binding update sent by this mobile node whose lifetime has not yet expired. The binding update list includes all binding updates sent by the mobile node—those bindings sent to correspondent nodes, those bindings sent to the mobile node's home agent.

The mobility extension header has a new routing header type and a new destination option, and it is used during the binding update process. This header is used by mobile nodes, correspondent nodes, and home agents in all messaging related to the creation and management of bindings.

Home Agents List

A home agents list is maintained by each home agent and each mobile node. The home agents list records information about each home agent from which this node has recently received a router advertisement in which the home agent (H) bit is set.

Each home agent maintains a separate home agents list for each link on which it is serving as a home agent. This list is used by a home agent in the dynamic home agent address discovery mechanism. Each roaming mobile node also maintains a home agents list that enables it to notify a home agent on its previous link when it moves to a new link.

How Mobile IPv6 Works

To implement Mobile IPv6, you need a home agent on the home subnet on which the mobile node's home address resides. The IPv6 home address (HOA) is assigned to the mobile node. The mobile node obtains a new IPv6 address (the COA) on networks to which it connects. The home agent accepts binding updates from the mobile node informing the agent of the mobile node's location. The home agent then acts as proxy for the mobile node, intercepting traffic to the mobile node's home address and tunneling it to the mobile node.

The mobile node informs a home agent on its original home network about its new address, and the correspondent node communicates with the mobile node about CoA. Because of the use of ingress filtering, the mobile node reverses tunnel return traffic to the home agent, so that the mobile node source address (that is, its home address) will always be topographically correct.

Mobile IPv6 is the ability of a mobile node to bypass the home agent when sending IP packets to a correspondent node. Optional extensions make direct routing possible in Mobile IPv6, though the extensions might not be implemented in all deployments of Mobile IPv6.

Direct routing is built into Mobile IPv6, and the direct routing function uses the IPv6 routing header and the IPv6 destination options header. The routing header is used for sending packets to the mobile node using its current COA, and the new home address destination option is used to include the mobile node's home address, because the current COA is the source address of the packet.

Packet Headers in Mobile IPv6

The basic IPv6 packet header has 8 fields with a total size of 40 octets (320 bits). Fields were removed from the IPv6 header compared with the IPv4 header because, in IPv6, fragmentation is not handled by routers and checksums at the network layer are not used. Instead, fragmentation in IPv6 is handled by the source of a packet and checksums at the data link layer and transport layer are used. Additionally, the basic IPv6 packet header and Options field are aligned to 64 bits, which can facilitate the processing of IPv6 packets.

Mobile IPv6 uses the routing and destination option headers for communications between the mobile node and the correspondent node. The new mobility option header is used only for the binding update process.

Several ICMP message types have been defined to support Mobile IPv6. IPv6 access lists can be configured to allow IPv6 access list entries matching Mobile-IPv6-specific ICMP messages to be configured and to allow the definition of entries to match packets containing Mobile IPv6 extension headers.

For further information on IPv6 packet headers, see the *Implementing Basic Connectivity for IPv6* module.

IPv6 Neighbor Discovery with Mobile IPv6

The IPv6 neighbor discovery feature has the following modifications to allow the feature to work with Mobile IPv6:

- Modified router advertisement message format—has a single flag bit that indicates home agent service.
- Modified prefix information option format—allows a router to advertise its global address.
- New advertisement interval option format

- New Home Agent information option format
- Changes to sending router advertisements
- Provide timely movement detection for mobile nodes

For further information on IPv6 neighbor discovery, refer to *Implementing Basic Connectivity for IPv6*.

How to Implement Mobile IPv6

The following tasks explain how to configure and start Mobile IPv6:

- [Enabling Mobile IPv6 on the Router, page 275](#)
- [Configuring Binding Information for Mobile IPv6, page 276](#)
- [Filtering Mobile IPv6 Protocol Headers and Options, page 278](#)
- [Controlling ICMP Unreachable Messages, page 279](#)
- [Customizing Mobile IPv6 on the Interface, page 280](#)
- [Monitoring and Maintaining Mobile IPv6 on the Router, page 281](#)

Enabling Mobile IPv6 on the Router

The following task describes how to enable Mobile IPv6 on a specified interface and display Mobile IPv6 information. You can customize interface configuration parameters before you start Mobile IPv6 (see “[Customizing Mobile IPv6 on the Interface](#)” section on page 280) or while Mobile IPv6 is in operation.

SUMMARY STEPS

1. **enable**
2. **configure terminal**
3. **interface** *type number*
4. **ipv6 mobile home-agent** [**preference** *preference-value*]
5. **exit**
6. **show ipv6 mobile home-agent** [*interface-type interface-number* [*prefix*]]

DETAILED STEPS

	Command or Action	Purpose
Step 1	enable Example: Router> enable	Enables privileged EXEC mode. <ul style="list-style-type: none">• Enter your password if prompted.
Step 2	configure terminal Example: Router# configure terminal	Enters global configuration mode.
Step 3	interface <i>type number</i> Example: Router(config)# interface Ethernet 2	Specifies an interface type and number, and places the router in interface configuration mode.
Step 4	ipv6 mobile home-agent [preference <i>preference-value</i>] Example: Router(config-if)# ipv6 mobile home-agent	Initializes and starts the IPv6 Mobile home agent on a specific interface.
Step 5	exit Example: Router(config-if)# exit	Exits interface configuration mode. Enter this command twice to return the router to privileged EXEC mode.
Step 6	show ipv6 mobile home-agent [<i>interface-type interface-number</i> [<i>prefix</i>]] Example: Router# show ipv6 mobile home-agent	Displays local and discovered neighboring home agents.

Configuring Binding Information for Mobile IPv6

Before you start Mobile IPv6 on a specified interface, you can configure binding information on the router. The following task describes how to configure binding information on the IPv6 router and to verify that the binding information is correct.

SUMMARY STEPS

1. **enable**
2. **configure terminal**
3. **ipv6 mobile home-agent**
4. **binding** [**access** *access-list-name* | *seconds* | *maximum* | *refresh*]
5. **exit**
6. **show ipv6 mobile binding** [**care-of-address** *address* | **home-address** *address* | *interface-type interface-number*]

7. **show ipv6 mobile traffic**
8. **show ipv6 mobile globals**

DETAILED STEPS

	Command or Action	Purpose
Step 1	enable Example: Router> enable	Enables privileged EXEC mode. <ul style="list-style-type: none"> • Enter your password if prompted.
Step 2	configure terminal Example: Router# configure terminal	Enters global configuration mode.
Step 3	ipv6 mobile home-agent Example: Router(config)# ipv6 mobile home-agent	Places the router in home agent configuration mode.
Step 4	binding [access <i>access-list-name</i> <i>seconds</i> <i>maximum</i> <i>refresh</i>] Example: Router(config-ha)# binding	Configures binding options for the Mobile IPv6 home agent feature.
Step 5	exit Example: Router(config-ha)# exit	Exits home-agent configuration mode. Enter this command twice to return the router to privileged EXEC mode.
Step 6	show ipv6 mobile binding [care-of-address <i>address</i> home-address <i>address</i> <i>interface-type</i> <i>interface-number</i>] Example: Router# show ipv6 mobile binding	Displays information about the binding cache.
Step 7	show ipv6 mobile traffic Example: Router# show ipv6 mobile traffic	Displays information about binding updates received and binding acknowledgments sent.
Step 8	show ipv6 mobile globals Example: Router# show ipv6 mobile globals	Displays global Mobile IPv6 parameters.

Filtering Mobile IPv6 Protocol Headers and Options

IPv6 extension headers have been developed to support the use of option headers specific to Mobile IPv6. The IPv6 mobility header, the type 2 routing header, and the destination option header allow the configuration of IPv6 access list entries that match Mobile-IPv6-specific ICMPv6 messages and allow the definition of entries to match packets that contain the new and modified IPv6 extension headers.

This task describes how to enable filtering of Mobile IPv6 protocol headers and options. For more information on how to create, configure, and apply IPv6 access lists, see *Implementing Security for IPv6*.

SUMMARY STEPS

1. **enable**
2. **configure terminal**
3. **ipv6 access-list** *access-list-name*
4. **permit icmp** { *source-ipv6-prefix/prefix-length* | **any** | **host** *source-ipv6-address* } [*operator* [*port-number*]] { *destination-ipv6-prefix/prefix-length* | **any** | **host** *destination-ipv6-address* } [*operator* [*port-number*]] [*icmp-type* [*icmp-code*] | *icmp-message*] [**dest-option-type** [*doh-number* | *doh-type*]] [**dscp** *value*] [**flow-label** *value*] [**fragments**] [**log**] [**log-input**] [**mobility**] [**mobility-type** [*mh-number* | *mh-type*]] [**routing**] [**routing-type** *routing-number*] [**sequence** *value*] [**time-range** *name*]
or
deny icmp { *source-ipv6-prefix/prefix-length* | **any** | **host** *source-ipv6-address* } [*operator* [*port-number*]] { *destination-ipv6-prefix/prefix-length* | **any** | **host** *destination-ipv6-address* } [*operator* [*port-number*]] [*icmp-type* [*icmp-code*] | *icmp-message*] [**dest-option-type** [*doh-number* | *doh-type*]] [**dscp** *value*] [**flow-label** *value*] [**fragments**] [**log**] [**log-input**] [**mobility**] [**mobility-type** [*mh-number* | *mh-type*]] [**routing**] [**routing-type** *routing-number*] [**sequence** *value*] [**time-range** *name*]

DETAILED STEPS

	Command or Action	Purpose
Step 1	enable Example: Router> enable	Enables privileged EXEC mode. <ul style="list-style-type: none"> • Enter your password if prompted.
Step 2	configure terminal Example: Router# configure terminal	Enters global configuration mode.

	Command or Action	Purpose
Step 3	<pre>ipv6 access-list access-list-name</pre> <p>Example: Router(config)# ipv6 access-list list1</p>	Defines an IPv6 access list and places the router in IPv6 access list configuration mode.
Step 4	<pre>permit icmp {source-ipv6-prefix/prefix-length any host source-ipv6-address} [operator [port-number]] {destination-ipv6-prefix/prefix-length any host destination-ipv6-address} [operator [port-number]] [icmp-type [icmp-code] icmp-message] [dest-option-type [doh-number doh-type]] [dscp value] [flow-label value] [fragments] [log] [log-input] [mobility] [mobility-type [mh-number mh-type]] [routing] [routing-type routing-number] [sequence value] [time-range name]</pre> <p>or</p> <pre>deny icmp {source-ipv6-prefix/prefix-length any host source-ipv6-address} [operator [port-number]] {destination-ipv6-prefix/prefix-length any host destination-ipv6-address} [operator [port-number]] [icmp-type [icmp-code] icmp-message] [dest-option-type [doh-number doh-type]] [dscp value] [flow-label value] [fragments] [log] [log-input] [mobility] [mobility-type [mh-number mh-type]] [routing] [routing-type routing-number] [sequence value] [time-range name]</pre> <p>Example: Router(config-ipv6-acl)# permit icmp host 2001:0DB8:0:4::32 any routing-type 2</p>	<p>Specifies permit or deny conditions for Mobile-IPv6-specific option headers in an IPv6 access list.</p> <ul style="list-style-type: none"> The <i>icmp-type</i> argument can be (but is not limited to) one of the following Mobile-IPv6-specific options: <ul style="list-style-type: none"> dhaad-request—numeric value is 144 dhaad-reply—numeric value is 145 mpd-solicitation—numeric value is 146 mpd-advertisement—numeric value is 147 When the dest-option-type keyword with the <i>doh-number</i> or <i>doh-type</i> argument is used, IPv6 packets are matched against the destination option extension header within each IPv6 packet header. When the mobility keyword is used, IPv6 packets are matched against the mobility extension header within each IPv6 packet header. When the mobility-type keyword with the <i>mh-number</i> or <i>mh-type</i> argument is used, IPv6 packets are matched against the mobility-type option extension header within each IPv6 packet header. When the routing-type keyword and <i>routing-number</i> argument are used, IPv6 packets are matched against the routing-type option extension header within each IPv6 packet header.

Controlling ICMP Unreachable Messages

When IPv6 is unable to route a packet, it generates an appropriate ICMP unreachable message directed toward the source of the packet. This task describes how to control ICMP unreachable messages for any packets arriving on a specified interface.

SUMMARY STEPS

1. **enable**
2. **configure {terminal}**
3. **interface type number**
4. **ipv6 unreachable**

DETAILED STEPS

	Command or Action	Purpose
Step 1	enable Example: Router> enable	Enables privileged EXEC mode. <ul style="list-style-type: none"> Enter your password if prompted.
Step 2	configure terminal Example: Router# configure terminal	Enters global configuration mode.
Step 3	interface <i>type number</i> Example: Router(config)# interface ethernet 0	Specifies the interface type and number, and enters interface configuration mode.
Step 4	ipv6 unreachable Example: Router(config-if)# ipv6 unreachable	Enables the generation of ICMPv6 unreachable messages for any packets arriving on the specified interface.

Customizing Mobile IPv6 on the Interface

This task describes how to customize interface configuration parameters for your router configuration and to display Mobile IPv6 information. You can set these interface configuration parameters before you start Mobile IPv6 or while Mobile IPv6 is in operation. You can customize any of these parameters, or you can customize none at all.

SUMMARY STEPS

- enable**
- configure terminal**
- interface** *type number*
- ipv6 mobile home-agent** [**preference** *preference-value*] (**interface configuration**)
- ipv6 nd advertisement-interval**
- ipv6 nd prefix** *ipv6-prefix/prefix-length* | **default** [[*valid-lifetime preferred-lifetime* | **at** *valid-date preferred-date*] | **infinite** | **no-advertise** | **off-link** | **no-rtr-address** | **no-autoconfig**]]
- ipv6 nd ra interval** {*maximum-secs* [*minimum-secs*] | **msec** *maximum-msecs* [*minimum-msecs*] }

DETAILED STEPS

	Command or Action	Purpose
Step 1	<p>enable</p> <p>Example: Router> enable</p>	<p>Enables privileged EXEC mode.</p> <ul style="list-style-type: none"> Enter your password if prompted.
Step 2	<p>configure terminal</p> <p>Example: Router# configure terminal</p>	<p>Enters global configuration mode.</p>
Step 3	<p>interface <i>type number</i></p> <p>Example: Router(config)# interface serial 3</p>	<p>Specifies an interface type and number, and places the router in interface configuration mode.</p>
Step 4	<p>ipv6 mobile home-agent [preference <i>preference-value</i>] (interface configuration)</p> <p>Example: Router(config-if)# ipv6 mobile home-agent preference 10</p>	<p>Configures the Mobile IPv6 home agent preference value on the interface.</p>
Step 5	<p>ipv6 nd advertisement-interval</p> <p>Example: Router(config-if)# ipv6 nd advertisement-interval</p>	<p>Configures the advertisement interval option to be sent in RAs.</p>
Step 6	<p>ipv6 nd prefix <i>ipv6-prefix/prefix-length</i> default [[<i>valid-lifetime preferred-lifetime</i> <i>at valid-date preferred-date</i>] infinite no-advertise off-link no-rtr-address no-autoconfig]]</p> <p>Example: Router(config-if)# ipv6 nd prefix 2001:0DB8::/35 1000 900 autoconfig</p>	<p>Configures which IPv6 prefixes are included in IPv6 RAs.</p>
Step 7	<p>ipv6 nd ra interval {<i>maximum-secs</i> [<i>minimum-secs</i>] msec <i>maximum-msecs</i> [<i>minimum-msecs</i>]}</p> <p>Example: Router(config-if)# ipv6 nd ra interval 201</p>	<p>Configures the interval between IPv6 RA transmissions on an interface.</p>

Monitoring and Maintaining Mobile IPv6 on the Router

This task describes many ways to monitor and maintain a Mobile IPv6 router, such as:

- Clear the Mobile IPv6 binding cache on a router
- Clear the neighboring home agents list

- Clear counters associated with Mobile IPv6
- Enable display of debugging information for Mobile IPv6
- Display memory used by the Mobile IPv6 internal structure

This task is optional, and these commands are used only as necessary to clear or display Mobile IPv6 information or enable Mobile IPv6 debugging.

SUMMARY STEPS

1. **enable**
2. **clear ipv6 mobile binding** [**care-of-address** *prefix* | **home-address** *prefix* | *interface-type interface-number*]
3. **clear ipv6 mobile home-agents** [*interface-type interface-number*]
4. **clear ipv6 mobile traffic**
5. **debug ipv6 mobile** {**binding-cache** | **forwarding** | **home-agent** | **registration**}
6. **show ipv6 mobile private**

DETAILED STEPS

	Command or Action	Purpose
Step 1	enable Example: Router> enable	Enables privileged EXEC mode. • Enter your password if prompted.
Step 2	clear ipv6 mobile binding [care-of-address <i>prefix</i> home-address <i>prefix</i> <i>interface-type interface-number</i>] Example: Router# clear ipv6 mobile binding	Clears the Mobile IPv6 binding cache on a router.
Step 3	clear ipv6 mobile home-agents [<i>interface-type interface-number</i>] Example: Router# clear ipv6 mobile home-agents	Clears the neighboring home agents list.
Step 4	clear ipv6 mobile traffic Example: Router# clear ipv6 mobile traffic	Clears the counters associated with Mobile IPv6.

	Command or Action	Purpose
Step 5	<pre>debug ipv6 mobile {binding-cache forwarding home-agent registration}</pre> <p>Example: Router# debug ipv6 mobile registration</p>	Enables the display of debugging information for Mobile IPv6.
Step 6	<pre>show ipv6 mobile private</pre> <p>Example: Router# show ipv6 mobile private</p>	Displays memory used by the Mobile IPv6 internal structure.

Verifying Mobile IPv6 Configuration and Operation

This section provides sample **show** command output to verify Mobile IPv6 configuration and operation.

- [Sample Output for the show ipv6 mobile binding Command](#)
- [Sample Output for the show ipv6 mobile globals Command](#)
- [Sample Output for the show ipv6 mobile traffic Command](#)
- [Sample Output for the show ipv6 mobile traffic Command](#)

Sample Output for the show ipv6 mobile binding Command

The following example displays information about the binding cache:

```
Router # show ipv6 mobile binding

Mobile IPv6 Binding Cache Entries:
2001:1::8
  via care-of address 2001:2::1
  home-agent 2001:1::2
  state ACTIVE, sequence 1, flags AHr1K
  lifetime:remaining 1023 (secs), granted 1024 (secs), requested 1024 (secs)
  interface Ethernet1/3
  0 tunneled, 0 reversed tunneled
Selection matched 1 bindings
```

Sample Output for the show ipv6 mobile globals Command

In the following example, the **show ipv6 mobile globals** command displays the binding parameters:

```
Router# show ipv6 mobile globals

Mobile IPv6 Global Settings:

  1 Home Agent service on following interfaces:
    Ethernet1/2
Bindings:
  Maximum number is unlimited.
  1 bindings are in use
  1 bindings peak
  Binding lifetime permitted is 262140 seconds
  Recommended refresh time is 300 seconds
```

Sample Output for the show ipv6 mobile home-agent Command

In the following example, the fact that no neighboring mobile home agents were found is displayed:

```
Router# show ipv6 mobile home-agent

Home Agent information for Ethernet1/3
Configured:
  FE80::20B:BFFF:FE33:501F
  preference 0 lifetime 1800
  global address 2001:0DB8:1::2/64
Discovered Home Agents:
  FE80::4, last update 0 min
  preference 0 lifetime 1800
  global address 2001:0DB8:1::4/64
```

Sample Output for the show ipv6 mobile traffic Command

In the following example, information about IPv6 Mobile traffic is displayed:

```
Router# show ipv6 mobile traffic

MIPv6 statistics:
  Rcvd: 6477 total
    0 truncated, 0 format errors
    0 checksum errors
  Binding Updates received:6477
    0 no HA option, 0 BU's length
    0 options' length, 0 invalid CoA
  Sent: 6477 generated
  Binding Acknowledgements sent:6477
    6477 accepted (0 prefix discovery required)
    0 reason unspecified, 0 admin prohibited
    0 insufficient resources, 0 home reg not supported
    0 not home subnet, 0 not home agent for node
    0 DAD failed, 0 sequence number
  Binding Errors sent:0
    0 no binding, 0 unknown MH

Home Agent Traffic:
  6477 registrations, 0 deregistrations
  00:00:23 since last accepted HA registration
  unknown time since last failed HA registration
  unknown last failed registration code
  Traffic forwarded:
    0 tunneled, 0 reversed tunneled
  Dynamic Home Agent Address Discovery:
    1 requests received, 1 replies sent
  Mobile Prefix Discovery:
    0 solicitations received, 0 advertisements sent
```

Configuration Examples for Mobile IPv6

This section provides the following configuration example:

- [Enabling Mobile IPv6 on the Router: Example, page 285](#)

Enabling Mobile IPv6 on the Router: Example

The following example shows how to configure and enable Mobile IPv6 on a specified interface:

```
Router> enable
Router# config terminal
Router(config)# interface Ethernet 1
Router(config-if)# ipv6 mobile home-agent
```

Additional References

For additional information related to implementing IPv6 basic connectivity, see the following sections.

Related Documents

Related Topic	Document Title
IPv6 supported feature list	<i>Start Here: Cisco IOS Software Release Specifics for IPv6 Features</i>
IPv6 commands: complete command syntax, command mode, defaults, usage guidelines, and examples	<i>Cisco IOS IPv6 Command Reference</i>
IPv6 simplified packet headers	“Simplified IPv6 Packet Header” section in <i>Implementing Basic Connectivity for IPv6</i>
IPv6 neighbor discovery	“IPv6 Neighbor Discovery” section in <i>Implementing Basic Connectivity for IPv6</i>
IPv6 stateless autoconfiguration	“IPv6 Stateless Autoconfiguration” section in <i>Implementing Basic Connectivity for IPv6</i>
IPv6 stateful autoconfiguration	“DHCP for IPv6 Prefix Delegation” section in <i>Implementing Basic Connectivity for IPv6</i>
IPv6 access lists	“Access Control Lists for IPv6 Traffic Filtering” section in <i>Implementing Traffic Filters and Firewalls for IPv6 Security</i>
IP addressing and IP services configuration tasks	“Configuring IP Addressing” and “Configuring IP Services” sections in the <i>Cisco IOS IP Configuration Guide, Release 12.4</i>
IP addressing and IP services commands: complete command syntax, command mode, defaults, usage guidelines, and examples	<i>Cisco IOS IP Command Reference, Volume 1 of 4: Addressing and Services, Release 12.4</i>
IPv4 configuration and command reference information	<i>Cisco IOS Release 12.4 Configuration Guides and Command References</i>

Standards

Standards	Title
No new or modified standards are supported by this feature, and support for existing standards has not been modified by this feature.	—

MIBs

MIBs	MIBs Link
	To locate and download MIBs for selected platforms, Cisco IOS releases, and feature sets, use Cisco MIB Locator found at the following URL: http://www.cisco.com/go/mibs

RFCs

RFCs	Title
RFC 3775	<i>Mobility Support in IPv6</i>

Technical Assistance

Description	Link
The Cisco Technical Support website contains thousands of pages of searchable technical content, including links to products, technologies, solutions, technical tips, and tools. Registered Cisco.com users can log in from this page to access even more content.	http://www.cisco.com/techsupport



Implementing IPv6 over MPLS

Multiprotocol Label Switching (MPLS) is deployed by many service providers in their IPv4 networks. Service providers want to introduce IPv6 services to their customers, but changes to their existing IPv4 infrastructure can be expensive and the cost benefit for a small amount of IPv6 traffic does not make economic sense. Several integration scenarios have been developed to leverage an existing IPv4 MPLS infrastructure and add IPv6 services without requiring any changes to the network backbone.

Finding Support Information for Platforms and Cisco IOS Software Images

Use Cisco Feature Navigator to find information about platform support and Cisco IOS software image support. Access Cisco Feature Navigator at <http://www.cisco.com/go/fn>. You must have an account on Cisco.com. If you do not have an account or have forgotten your username or password, click **Cancel** at the login dialog box and follow the instructions that appear.

Contents

- [Prerequisites for Implementing IPv6 over MPLS, page 287](#)
- [Information About Implementing IPv6 over MPLS, page 288](#)
- [How to Implement IPv6 over MPLS, page 292](#)
- [Configuration Examples for IPv6 over MPLS, page 300](#)
- [Where to Go Next, page 302](#)
- [Additional References, page 303](#)

Prerequisites for Implementing IPv6 over MPLS

- This module assumes that you are familiar with IPv4. Refer to the publications referenced in the “[Related Documents](#)” section for IPv4 configuration and command reference information.
- Before the IPv6 Provider Edge Router over MPLS (6PE) feature can be implemented, MPLS must be running over the core IPv4 network. If Cisco routers are used, Cisco Express Forwarding (CEF) or distributed CEF (dCEF) must be enabled for both IPv4 and IPv6 protocols. This module assumes that you are familiar with MPLS.

[Table 20](#) identifies the earliest release for each early-deployment train in which the feature became available.

Table 20 Minimum Required Cisco IOS Release

Feature	Minimum Required Cisco IOS Release by Release Train
IPv6 over a circuit transport over IPv6	12.2(15)T, 12.0(22)S, 12.2(14)S, 12.3, 12.3(2)T, 12.4, 12.4(2)T, 12.2(28)SB
IPv6 using tunnels over the customer edge routers	12.2(15)T, 12.0(22)S, 12.2(14)S, 12.3, 12.3(2)T, 12.4, 12.4(2)T, 12.2(28)SB
IPv6 on the provider edge routers (6PE)	12.2(15)T, 12.0(22)S, 12.2(14)S, 12.3, 12.3(2)T, 12.4, 12.4(2)T, 12.2(28)SB, 12.2(33)SRA
6PE multipath	12.2(25)S, 12.4(6)T, 12.2(28)SB, 12.2(33)SRA

Information About Implementing IPv6 over MPLS

To configure IPv6 over MPLS, you need to understand the following concepts:

- [Benefits of Deploying IPv6 over MPLS Backbones](#), page 288
- [IPv6 over a Circuit Transport over MPLS](#), page 288
- [IPv6 Using Tunnels on the Customer Edge Routers](#), page 289
- [IPv6 on the Provider Edge Routers \(6PE\)](#), page 290

Benefits of Deploying IPv6 over MPLS Backbones

IPv6 over MPLS backbones enables isolated IPv6 domains to communicate with each other over an MPLS IPv4 core network. This implementation requires only a few backbone infrastructure upgrades and no reconfiguration of core routers because forwarding is based on labels rather than the IP header itself, providing a very cost-effective strategy for the deployment of IPv6.

Additionally, the inherent Virtual Private Network (VPN) and MPLS traffic engineering (MPLS-TE) services available within an MPLS environment allow IPv6 networks to be combined into IPv4 VPNs or extranets over an infrastructure supporting IPv4 VPNs and MPLS-TE. IPv6 VPNs are not supported.

IPv6 over a Circuit Transport over MPLS

Using any circuit transport for deploying IPv6 over MPLS networks has no impact on the operation or infrastructure of MPLS, and requires no configuration changes to the core or provider edge routers. Communication between the remote IPv6 domains runs native IPv6 protocols over a dedicated link, where the underlying mechanisms are fully transparent to IPv6. The IPv6 traffic is tunneled using the Any Transport over MPLS (MPLS/AToM) or Ethernet over MPLS (EoMPLS) feature with the routers connected through an ATM OC-3 or Ethernet interface, respectively.

[Figure 24](#) shows the configuration for IPv6 over any circuit transport over MPLS.

Figure 24 IPv6 over a Circuit Transport over MPLS

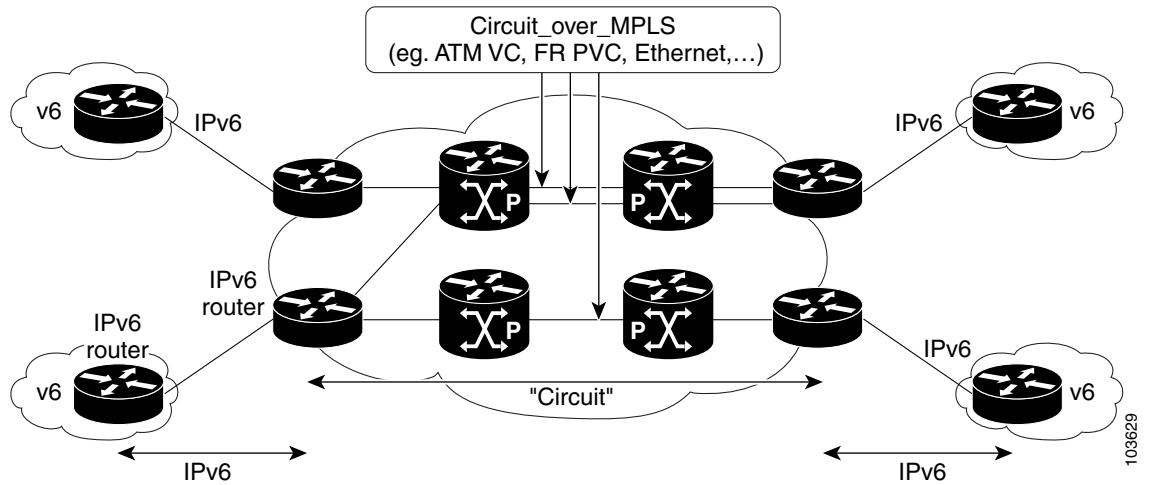

IPv6 Using Tunnels on the Customer Edge Routers

Using tunnels on the customer edge (CE) routers is the simplest way of deploying IPv6 over MPLS networks with no impact on the operation or infrastructure of MPLS, and no configuration changes to the core or provider edge routers. Communication between the remote IPv6 domains uses standard tunneling mechanisms and requires the CE routers to be configured to run dual IPv4 and IPv6 protocol stacks. [Figure 25](#) shows the configuration using tunnels on the CE routers.

Figure 25 IPv6 Using Tunnels on the CE Routers

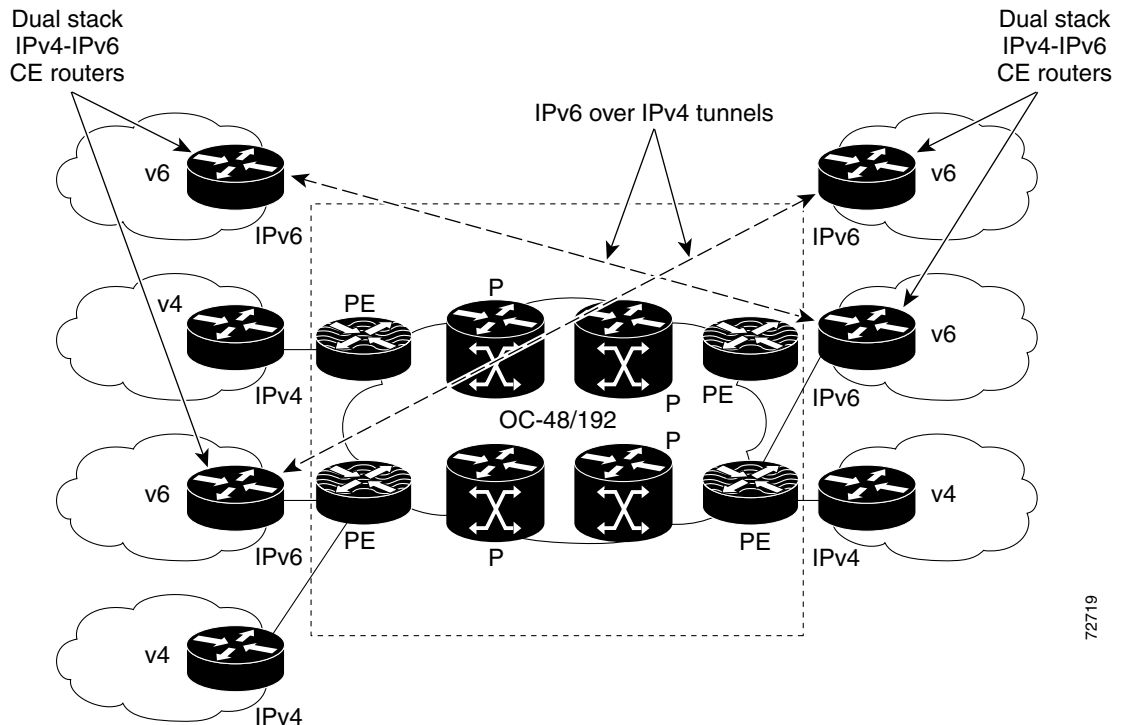

72719

Refer to the *Implementing Tunnels for IPv6* module for configuration information on manually configured tunnels, automatic tunnels, and 6to4 tunnels.

Limitations on using tunnels involve the manual configuring of a mesh of tunnels on the CE routers, creating scaling issues for large networks.

IPv6 on the Provider Edge Routers (6PE)

The Cisco implementation of IPv6 provider edge router over MPLS is referred to as Cisco 6PE and enables IPv6 sites to communicate with each other over an MPLS IPv4 core network using MPLS label switched paths (LSPs). This feature relies on multiprotocol Border Gateway Protocol (BGP) extensions in the IPv4 network configuration on the provider edge (PE) router to exchange IPv6 reachability information in addition to an MPLS label for each IPv6 address prefix to be advertised. Edge routers are configured to be dual stack running both IPv4 and IPv6, and use the IPv4 mapped IPv6 address for IPv6 prefix reachability exchange.

A hierarchy of labels is imposed on the 6PE ingress router to keep the IPv6 traffic transparent to all the core routers. The top label provides connectivity inside the IPv4 MPLS core network and the label is distributed by Label Distribution Protocol (LDP), Tag Distribution Protocol (TDP), or Resource Reservation Protocol (RSVP). TDP and LDP can both be used for label distribution, but RSVP is used only in the context of MPLS-TE label exchange. The bottom label, automatically assigned to the IPv6 prefix of the destination, is distributed by multiprotocol BGP and used at each 6PE egress router for IPv6 forwarding.

In [Figure 26](#) the 6PE routers are configured as dual stack routers able to route both IPv4 and IPv6 traffic. Each 6PE router is configured to run LDP, TDP, or RSVP (if traffic engineering is configured) to bind the IPv4 labels. The 6PE routers use multiprotocol BGP to exchange reachability information with the other 6PE devices within the MPLS domain, and to distribute aggregate IPv6 labels between them. All

6PE and core routers—P routers in Figure 3—within the MPLS domain share a common IPv4 Interior Gateway Protocol (IGP) such as Open Shortest Path First (OSPF) or Integrated Intermediate System-to-Intermediate System (IS-IS).

Figure 26 6PE Router Topology

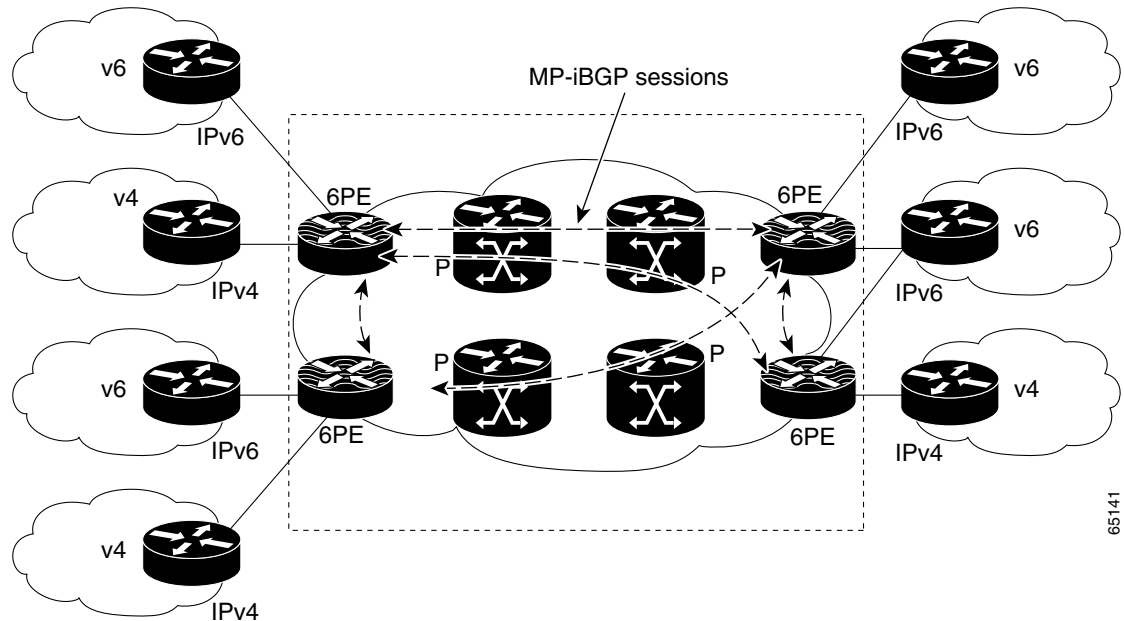

65141

The interfaces on the 6PE routers connecting to the CE router can be configured to forward IPv6 traffic, IPv4 traffic, or both types of traffic depending on the customer requirements. 6PE routers advertise IPv6 reachability information learned from their 6PE peers over the MPLS cloud. Service providers can delegate an IPv6 prefix from their registered IPv6 prefixes over the 6PE infrastructure; otherwise, there is no impact on the CE router.

The P routers in the core of the network are not aware that they are switching IPv6 packets. Core routers are configured to support MPLS and the same IPv4 IGP as the PE routers to establish internal reachability inside the MPLS cloud. Core routers also use LDP, TDP, or RSVP for binding IPv4 labels. Implementing the Cisco 6PE feature does not have any impact on the MPLS core devices.

Within the MPLS network, IPv6 traffic is forwarded using label switching, making the IPv6 traffic transparent to the core of the MPLS network. No IPv6 over IPv4 tunnels or Layer 2 encapsulation methods are required.

6PE Multipath

Internal and external Border Gateway Protocol (BGP) multipath for IPv6 allows the IPv6 router to load balance between several paths (for example, same neighboring autonomous system [AS] or sub-AS, or the same metric) to reach its destination. The 6PE multipath feature uses multiprotocol internal BGP (MP-iBGP) to distribute IPv6 routes over the MPLS IPv4 core network and to attach an MPLS label to each route.

When MP-iBGP multipath is enabled on the 6PE router, all labeled paths are installed in the forwarding table with MPLS information (label stack) when MPLS information is available. This functionality enables 6PE to perform load balancing.

How to Implement IPv6 over MPLS

The following sections explain how to configure IPv6 over MPLS:

- [Deploying IPv6 over a Circuit Transport over MPLS](#), page 292
- [Deploying IPv6 on the Provider Edge Routers \(6PE\)](#), page 292
- [Configuring iBGP Multipath Load Sharing](#), page 296
- [Verifying 6PE Configuration and Operation](#), page 297

Deploying IPv6 over a Circuit Transport over MPLS

To deploy IPv6 over a circuit transport over MPLS, the IPv6 routers must be configured for IPv6 connectivity. Refer to the *Implementing Basic Connectivity for IPv6* module for details on basic IPv6 configuration. The MPLS router configuration requires AToM configuration or EoMPLS configuration. Refer to the AToM new feature module in Cisco IOS Release 12.0(23)S for details on configuration and command reference information.

Deploying IPv6 on the Provider Edge Routers (6PE)

To implement IPv6 on provider edge routers two tasks must be completed. The first task is to specify the interface from which locally generated packets take their source IPv6 address. The second task is to bind and advertise aggregate labels.

Each 6PE router—6PE1 and 6PE2 in [Figure 27](#)—is assumed to be running IPv4 routing and CEF.

6PE Network Configuration

Two configuration tasks using the network shown in [Figure 27](#) are required at the 6PE1 router to enable the 6PE feature.

The customer edge router—CE1 in [Figure 27](#)—is configured to forward its IPv6 traffic to the 6PE1 router. The P1 router in the core of the network is assumed to be running MPLS, a label distribution protocol, an IPv4 IGP, and CEF or dCEF, and does not require any new configuration to enable the 6PE feature. Although new configuration tasks are not required for the CE1 and P1 routers, configuration examples are shown for reference in the “[6PE Configuration Example](#)” section.

Figure 27 6PE Configuration Example

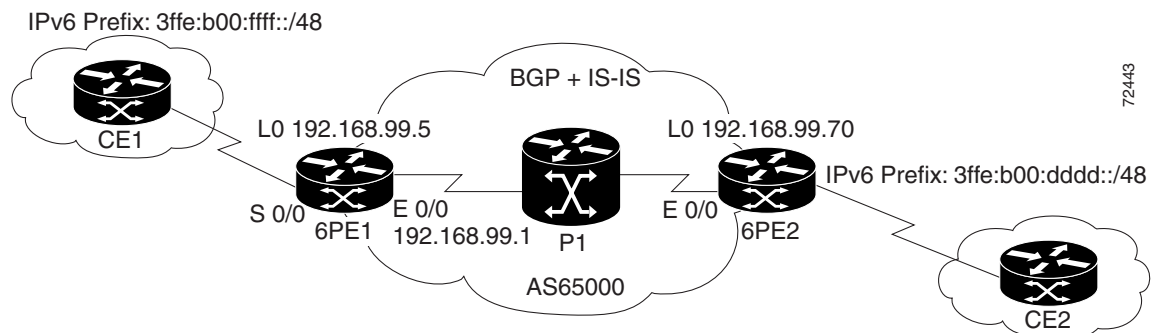

Prerequisites

- The 6PE routers—the 6PE1 and 6PE2 routers in [Figure 27](#)—must be members of the core IPv4 network. The 6PE router interfaces attached to the core network must be running MPLS, the same label distribution protocol, and the same IPv4 IGP, as in the core network.
- The 6PE routers must also be configured to be dual stack to run both IPv4 and IPv6.

Restrictions



Note

As of Cisco IOS Release 12.2(22)S, the following restrictions do not apply to Cisco IOS 12.2 S releases.

The following restrictions apply when implementing the IPv6 Provider Edge Router over MPLS (6PE) feature:

- Core MPLS routers are supporting MPLS and IPv4 only, so they cannot forward or create any IPv6 Internet Control Message Protocol (ICMP) messages.
- Load balancing ability is not provided by Cisco 6PE between an MPLS path and an IPv6 path. If both are available, the MPLS path is always preferred. Load balancing between two MPLS paths is possible.
- BGP multipath is not supported for Cisco 6PE routes. If two BGP peers advertise the same prefix with an equal cost, Cisco 6PE will use the last route to cross the MPLS core.
- 6PE feature is not supported over tunnels other than RSVP-TE tunnels.

Specifying the Source Address Interface on a 6PE Router

This task explains how to specify the interface from which locally generated packets take their source IPv6 address. This task is the first of two tasks that must be completed to deploy 6PE. See the “[Binding and Advertising the 6PE Label to Advertise Prefixes](#)” task for details about the second task required to implement 6PE.

SUMMARY STEPS

1. **enable**
2. **configure terminal**
3. **ipv6 unicast-routing**
4. **ipv6 cef**
5. **interface** *type number*
6. **ipv6 address** {*ipv6-address/prefix-length* | *prefix-name sub-bits/prefix-length*}
7. **exit**
8. **mpls ipv6 source-interface** *type number*

DETAILED STEPS

	Command or Action	Purpose
Step 1	<code>enable</code> Example: Router> enable	Enables privileged EXEC mode. <ul style="list-style-type: none"> Enter your password if prompted.
Step 2	<code>configure terminal</code> Example: Router# configure terminal	Enters global configuration mode.
Step 3	<code>ipv6 unicast-routing</code> Example: Router(config)# ipv6 unicast-routing	Enables the forwarding of IPv6 unicast datagrams.
Step 4	<code>ipv6 cef</code> Example: Router(config)# ipv6 cef	Enables IPv6 CEF.
Step 5	<code>interface type number</code> Example: Router(config)# interface Serial 0/0	Specifies an interface type and number and enters interface configuration mode. <ul style="list-style-type: none"> In the context of this feature, the interface to be configured is the interface communicating with the CE router.
Step 6	<code>ipv6 address {ipv6-address/prefix-length prefix-name sub-bits/prefix-length}</code> Example: Router(config-if)# ipv6 address 2001:0DB8:FFFF::2/64	Configures an IPv6 address based on an IPv6 general prefix and enable IPv6 processing on an interface.
Step 7	<code>exit</code> Example: Router(config-if)# exit	Exits interface configuration mode and enters global configuration mode.
Step 8	<code>mpls ipv6 source-interface type number</code> Example: Router(config)# mpls ipv6 source-interface Loopback 0	Specifies the interface type and number from which MPLS will take the IPv6 address as a source address. Note Effective with release 12.2(25)S, the mpls ipv6 source-interface command is no longer available in Cisco IOS software.

Binding and Advertising the 6PE Label to Advertise Prefixes

This task is the second task required for implementing 6PE. The [“Specifying the Source Address Interface on a 6PE Router”](#) task must be completed first. This task explains how to enable the binding and advertising of aggregate labels when advertising IPv6 prefixes to a specified BGP neighbor.

SUMMARY STEPS

1. **enable**
2. **configure terminal**
3. **router bgp** *as-number*
4. **no bgp default ipv4-unicast**
5. **neighbor** {*ip-address* | *ipv6-address* | *peer-group-name*} **remote-as** *as-number*
6. **neighbor** {*ip-address* | *ipv6-address* | *peer-group-name*} **update-source** *interface-type interface-number*
7. **address-family ipv6** [**unicast**]
8. **neighbor** {*ip-address* | *peer-group-name* | *ipv6-address*} **activate**
9. **neighbor** {*ip-address* | *ipv6-address*} **send-label**

DETAILED STEPS

	Command or Action	Purpose
Step 1	enable Example: Router> enable	Enables privileged EXEC mode. <ul style="list-style-type: none">• Enter your password if prompted.
Step 2	configure terminal Example: Router# configure terminal	Enters global configuration mode.
Step 3	router bgp <i>as-number</i> Example: Router(config)# router bgp 65000	Enters router configuration mode for the specified routing process.
Step 4	no bgp default ipv4-unicast Example: Router(config-router)# no bgp default ipv4-unicast	Disables the IPv4 unicast address family for the BGP routing process specified in the previous step. Note Routing information for the IPv4 unicast address family is advertised by default for each BGP routing session configured with the neighbor remote-as router configuration command unless you configure the no bgp default ipv4-unicast router configuration command before configuring the neighbor remote-as command.
Step 5	neighbor { <i>ip-address</i> <i>ipv6-address</i> <i>peer-group-name</i> } remote-as <i>as-number</i> Example: Router(config-router)# neighbor 192.168.99.70 remote-as 65000	Adds the IP address of the neighbor in the specified autonomous system to the BGP neighbor table of the local router.

	Command or Action	Purpose
Step 6	<p>neighbor {<i>ip-address</i> <i>ipv6-address</i> <i>peer-group-name</i>} update-source <i>interface-type</i> <i>interface-number</i></p> <p>Example: Router(config-router)# neighbor 192.168.99.70 update-source Loopback 0</p>	<p>Specifies the interface whose IPv4 address is to be used as the source address for the peering.</p> <ul style="list-style-type: none"> In the context of this task, the interface must have an IPv4 address with a 32-bit mask configured. Use of a loopback interface is recommended. This address is used to determine the IPv6 next hop by the peer 6PE.
Step 7	<p>address-family ipv6 [unicast]</p> <p>Example: Router(config-router)# address-family ipv6</p>	<p>Specifies the IPv6 address family and enters address family configuration mode.</p> <ul style="list-style-type: none"> The unicast keyword specifies the IPv6 unicast address family. By default, the router is placed in configuration mode for the IPv6 unicast address family if the unicast keyword is not specified with the address-family ipv6 command.
Step 8	<p>neighbor {<i>ip-address</i> <i>peer-group-name</i> <i>ipv6-address</i>} activate</p> <p>Example: Router(config-router-af)# neighbor 192.168.99.70 activate</p>	<p>Enables the neighbor to exchange prefixes for the IPv6 address family with the local router.</p>
Step 9	<p>neighbor {<i>ip-address</i> <i>ipv6-address</i>} send-label</p> <p>Example: Router(config-router-af)# neighbor 192.168.99.70 send-label</p>	<p>Advertises the capability of the router to send MPLS labels with BGP routes.</p> <ul style="list-style-type: none"> In IPv6 address family configuration mode this command enables binding and advertisement of aggregate labels when advertising IPv6 prefixes in BGP.

Configuring iBGP Multipath Load Sharing

This task describes how to configure iBGP multipath load sharing and control the maximum number of parallel iBGP routes that can be installed in a routing table.

SUMMARY STEPS

1. **enable**
2. **configure terminal**
3. **router bgp** *as-number*
4. **maximum-paths ibgp** *number-of-paths*

DETAILED STEPS

	Command or Action	Purpose
Step 1	enable Example: Router> enable	Enables privileged EXEC mode. <ul style="list-style-type: none"> Enter your password if prompted.
Step 2	configure terminal Example: Router# configure terminal	Enters global configuration mode.
Step 3	router bgp as-number Example: Router(config)# router bgp 65000	Enters router configuration mode for the specified routing process.
Step 4	maximum-paths ibgp number-of-paths Example: Router(config-router)# maximum-paths ibgp 3	Controls the maximum number of parallel iBGP routes that can be installed in a routing table.

Verifying 6PE Configuration and Operation

When 6PE is running the following components can be monitored:

- Multiprotocol BGP
- MPLS
- CEFv6
- IPv6 routing table

This optional task explains how to display information about the various components to verify the configuration and operation of 6PE.

SUMMARY STEPS

1. **show bgp ipv6** {unicast | multicast} [ipv6-prefix/prefix-length] [longer-prefixes] [labels]
2. **show bgp ipv6** {unicast | multicast} neighbors [ipv6-address] [received-routes | routes | flap-statistics | advertised-routes | paths regular-expression | dampened-routes]
3. **show mpls forwarding-table** [network {mask | length} | labels label [-label] | interface interface | next-hop address | lsp-tunnel [tunnel-id]] [vrf vrf-name] [detail]
4. **show ipv6 cef** [ipv6-prefix/prefix-length] | [interface-type interface-number] [longer-prefixes | similar-prefixes | detail | internal | platform | epoch | source]]
5. **show ipv6 route** [ipv6-address | ipv6-prefix/prefix-length | protocol | interface-type interface-number]

DETAILED STEPS

	Command or Action	Purpose
Step 1	<pre>show bgp ipv6 {unicast multicast} [ipv6-prefix/prefix-length] [longer-prefixes] [labels]</pre> <p>Example: Router> show bgp ipv6 unicast 2001:0DB8:DDDD::/48</p>	(Optional) Displays entries in the IPv6 BGP routing table. <ul style="list-style-type: none"> In this example, information about the IPv6 route for the prefix 2001:0DB8:DDDD::/48 is displayed.
Step 2	<pre>show bgp ipv6 {unicast multicast} neighbors [ipv6-address] [received-routes routes flap-statistics advertised-routes paths regular-expression dampened-routes]</pre> <p>Example: Router> show bgp ipv6 neighbors unicast 192.168.99.70</p>	(Optional) Displays information about IPv6 BGP connections to neighbors. <ul style="list-style-type: none"> In this example, information including the IPv6 label capability is displayed for the BGP peer at 192.168.99.70.
Step 3	<pre>show mpls forwarding-table [network {mask length} labels label [-label] interface interface nexthop address lsp-tunnel [tunnel-id]] [vrf vrf-name] [detail]</pre> <p>Example: Router> show mpls forwarding-table</p>	(Optional) Displays the contents of the MPLS Forwarding Information Base (FIB). <ul style="list-style-type: none"> In this example, information linking the MPLS label with IPv6 prefixes is displayed where the labels are shown as aggregate and the prefix is shown as IPv6.
Step 4	<pre>show ipv6 cef [ipv6-prefix/prefix-length] [interface-type interface-number] [longer-prefixes similar-prefixes detail internal platform epoch source]]</pre> <p>Example: Router> show ipv6 cef 2001:0DB8:DDDD::/64</p>	(Optional) Displays FIB entries based on IPv6 address information. <ul style="list-style-type: none"> In this example, label information from the CEF table for prefix 2001:0DB8:DDDD::/64 is displayed.
Step 5	<pre>show ipv6 route [ipv6-address ipv6-prefix/prefix-length protocol interface-type interface-number]</pre> <p>Example: Router> show ipv6 route</p>	(Optional) Displays the current contents of the IPv6 routing table.

Output Examples

This section provides the following output examples:

- [Sample Output for the show bgp ipv6 Command, page 299](#)
- [Sample Output for the show bgp ipv6 neighbors Command, page 299](#)
- [Sample Output for the show mpls forwarding-table Command, page 299](#)
- [Sample Output for the show bgp ipv6 Command, page 300](#)
- [Sample Output for the show ipv6 cef Command, page 300](#)
- [Sample Output for the show ipv6 route Command, page 300](#)

Sample Output for the show bgp ipv6 Command

In the following example, output information about an IPv6 route is displayed using the **show bgp ipv6** user EXEC command with an IPv6 prefix:

```
Router> show bgp ipv6 2001:0DB8:DDDD::/48

BGP routing table entry for 2001:0DB8:DDDD::/48, version 15
Paths: (1 available, best #1, table Global-IPv6-Table)
  Not advertised to any peer
  Local
    ::FFFF:192.168.99.70 (metric 20) from 192.168.99.70 (192.168.99.70)
      Origin IGP, localpref 100, valid, internal, best
```

Sample Output for the show bgp ipv6 neighbors Command

In the following example, output information about a BGP peer including the “IPv6 label” capability is displayed using the **show bgp ipv6 neighbors** user EXEC command with an IP address:

```
Router> show bgp ipv6 neighbors 192.168.99.70

BGP neighbor is 192.168.99.70, remote AS 65000, internal link
  BGP version 4, remote router ID 192.168.99.70
  BGP state = Established, up for 00:05:17
  Last read 00:00:09, hold time is 0, keepalive interval is 60 seconds
  Neighbor capabilities:
    Route refresh: advertised and received
    Address family IPv6 Unicast: advertised and received
    ipv6 MPLS Label capability: advertised and received
  Received 54 messages, 0 notifications, 0 in queue
  Sent 55 messages, 1 notifications, 0 in queue
  Default minimum time between advertisement runs is 5 seconds

For address family: IPv6 Unicast
  BGP table version 21880, neighbor version 21880
  Index 1, Offset 0, Mask 0x2
  Route refresh request: received 0, sent 0
  77 accepted prefixes consume 4928 bytes
  Prefix advertised 4303, suppressed 0, withdrawn 1328
  Number of NLRIs in the update sent: max 1, min 0
```

Sample Output for the show mpls forwarding-table Command

In the following example, output information linking the MPLS label with prefixes is displayed using the **show mpls forwarding-table** user EXEC command. If the 6PE feature is configured, the labels are aggregated because there are several prefixes for one local label, and the prefix column contains “IPv6” instead of a target prefix.

```
Router> show mpls forwarding-table

Local Outgoing Prefix Bytes tag Outgoing Next Hop
tag tag or VC or Tunnel Id switched interface
16 Aggregate IPv6 0
17 Aggregate IPv6 0
18 Aggregate IPv6 0
19 Pop tag 192.168.99.64/30 0 Se0/0 point2point
20 Pop tag 192.168.99.70/32 0 Se0/0 point2point
21 Pop tag 192.168.99.200/32 0 Se0/0 point2point
22 Aggregate IPv6 5424
23 Aggregate IPv6 3576
24 Aggregate IPv6 2600
```

Sample Output for the show bgp ipv6 Command

In the following example, output information about the top of the stack label with label switching information is displayed using the **show bgp ipv6** user EXEC command with the **labels** keyword:

```
Router> show bgp ipv6 labels

Network                Next Hop                In tag/Out tag
2001:0DB8:DDDD::/64    ::FFFF:192.168.99.70    notag/20
```

Sample Output for the show ipv6 cef Command

In the following example, output information about labels from the CEF table is displayed using the **show ipv6 cef** command with an IPv6 prefix:

```
Router> show ipv6 cef 2001:0DB8:DDDD::/64

2001:0DB8:DDDD::/64
  nexthop ::FFFF:192.168.99.70
  fast tag rewrite with Se0/0, point2point, tags imposed {19 20}
```

Sample Output for the show ipv6 route Command

In the following example, output information from the IPv6 routing table is displayed using the **show ipv6 route** user EXEC command. The output shows the IPv6 MPLS virtual interface as the output interface of IPv6 routes forwarded across the MPLS cloud. In this example using the routers in [Figure 27](#), the output is from the 6PE1 router.

The 6PE2 router has advertised the IPv6 prefix of 2001:0DB8:dddd::/48 configured for the CE2 router and the next-hop address is the IPv4-compatible IPv6 address ::ffff:192.168.99.70, where 192.168.99.70 is the IPv4 address of the 6PE2 router.

```
Router> show ipv6 route

IPv6 Routing Table - 10 entries
Codes: C - Connected, L - Local, S - Static, R - RIP, B - BGP
I1 - ISIS L1, I2 - ISIS L2, IA - ISIS interarea
B 2001:0DB8:DDDD::/64 [200/0]
  via ::FFFF:192.168.99.70, IPv6-mpls
B 2001:0DB8:DDDD::/64 [200/0]
  via ::FFFF:192.168.99.70, IPv6-mpls
L 2001:0DB8:FFFF::1/128 [0/0]
  via ::, Ethernet0/0
C 2001:0DB8:FFFF::/64 [0/0]
  via ::, Ethernet0/0
S 2001:0DB8:FFFF::/48 [1/0]
  via 2001:0DB8:B00:FFFF::2, Ethernet0/0
```



Note

For a description of each output display field, refer to the relevant **show** command in the *IPv6 for Cisco IOS Command Reference*.

Configuration Examples for IPv6 over MPLS

This section provides the following configuration example:

- [6PE Configuration Example, page 301](#)

6PE Configuration Example

The following examples show configuration examples for three of the routers shown in [Figure 27](#) and used in the “[Specifying the Source Address Interface on a 6PE Router](#)” and “[Binding and Advertising the 6PE Label to Advertise Prefixes](#)” sections.

Customer Edge Router

In the following example, serial interface 0/0 of the customer edge router—CE1 in [Figure 27](#)—is connected to the service provider and is assigned an IPv6 address. IPv6 is enabled and a default static route is installed using the IPv6 address of serial interface 0/0 of the 6PE1 router.

```
ip cef
!
ipv6 unicast-routing
!
interface Serial 0/0
  description to_6PE1_router
  no ip address
  ipv6 address 2001:0DB8:FFFF::2/64
!
ipv6 route ::/0 Serial 0/0 FE80::210:XXXX:FEE1:1001
```

Provider Edge Router

The 6PE router—Router 6PE1 in [Figure 27](#)—is configured for both IPv4 and IPv6 traffic. Ethernet interface 0/0 is configured with an IPv4 address and is connected to a router in the core of the network—router P1 in [Figure 27](#). Integrated IS-IS and TDP configurations on this router are similar to the P1 router.

Router 6PE1 exchanges IPv6 routing information with another 6PE router—Router 6PE2 in [Figure 27](#)—using internal BGP (iBGP) established over an IPv4 connection so that all the **neighbor** commands use the IPv4 address of the 6PE2 router. All the BGP peers are within autonomous system 65000, so synchronization with IGP is turned off for IPv4. In IPv6 address family configuration mode, synchronization is disabled by default.

IPv6 and CEFv6 are enabled, the 6PE2 neighbor is activated, and aggregate label binding and advertisement is enabled for IPv6 prefixes using the **neighbor send-label** command. Connected and static IPV6 routes are redistributed using BGP. If IPv6 packets are generated in the local router, the IPv6 address for MPLS processing will be the address of loopback interface 0.

In the following example, serial interface 0/0 connects to the customer and the IPv6 prefix delegated to the customer is 2001:0DB8:ffff::/48, which is determined from the service provider IPv6 prefix. A static route is configured to route IPv6 packets between the 6PE route and the CE router.

```
ip cef
ipv6 cef
ipv6 unicast-routing
!
mpls ipv6 source-interface Loopback0
tag-switching tdp router-id Loopback0
!
interface Loopback0
  ip address 192.168.99.5 255.255.255.255
  ipv6 address 2001:0DB8:1000:1::1/64
!
interface Ethernet0/0
  description to_P_router
  ip address 192.168.99.1 255.255.255.252
  ip router isis
  tag-switching ip
```

```

!
interface Serial0/0
  description to_CE_router
  no ip address
  ipv6 address 2001:0DB8:FFFF::1/64
!
router isis
  passive-interface Loopback0
  net 49.0001.1921.6809.9005.00
!
router bgp 65000
  no bgp default ipv4-unicast
  bgp log-neighbor-changes
  neighbor 192.168.99.70 remote-as 65000
  neighbor 192.168.99.70 description to_6PE2
  neighbor 192.168.99.70 update-source Loopback0
!
  address-family ipv6
    neighbor 192.168.99.70 activate
    neighbor 192.168.99.70 send-label
    network 2001:0DB8:FFFF::/48
  exit-address-family
!
ipv6 route 2001:0DB8:FFFF::/48 Ethernet0/0 2001:0DB8:FFFF::2

```

Core Router

In the following example, the router in the core of the network—Router P in [Figure 27](#)—is running MPLS, IS-IS, and IPv4 only. The Ethernet interfaces are configured with IPv4 address and are connected to the 6PE routers. IS-IS is the IGP for this network and the P1 and 6PE routers are in the same IS-IS area 49.0001. TDP and tag switching are enabled on both the Ethernet interfaces. CEF is enabled in global configuration mode.

```

ip cef
!
tag-switching tdp router-id Loopback0
!
interface Loopback0
  ip address 192.168.99.200 255.255.255.255
!
interface Ethernet0/0
  description to_6PE1
  ip address 192.168.99.2 255.255.255.252
  ip router isis
  tag-switching ip
!
interface Ethernet0/1
  description to_6PE2
  ip address 192.168.99.66 255.255.255.252
  ip router isis
  tag-switching ip

router isis
  passive-interface Loopback0
  net 49.0001.1921.6809.9200.00

```

Where to Go Next

If you want to further customize your MPLS network, refer to the *Cisco IOS Switching Services Configuration Guide*, Release 12.4.

Additional References

For additional information related to IPv6 over MPLS, see the following sections.

Related Documents

Related Topic	Document Title
MPLS configuration tasks	“Configuring Multiprotocol Label Switching” chapter in the <i>Cisco IOS Switching Services Configuration Guide</i> , Release 12.4
MPLS commands: complete command syntax, command mode, defaults, usage guidelines, and examples	<i>Cisco IOS Switching Services Command Reference</i> , Release 12.4
IPv6 supported feature list	<i>Start Here: Cisco IOS Software Release Specifics for IPv6 Features</i>
IPv6 commands: complete command syntax, command mode, defaults, usage guidelines, and examples	<i>IPv6 for Cisco IOS Command Reference</i>
IPv4 configuration and command reference information	<i>Cisco IOS Release 12.4 Configuration Guides and Command References</i>

Standards

Standards	Title
Draft-ietf-ngtrans-bgp-tunnel-04.txt	<i>Connecting IPv6 Islands Across IPv4 Clouds with BGP</i>

MIBs

MIBs	MIBs Link
No new or modified MIBs are supported by this feature, and support for existing MIBs has not been modified by this feature.	To locate and download MIBs for selected platforms, Cisco IOS releases, and feature sets, use Cisco MIB Locator found at the following URL: http://www.cisco.com/go/mibs

RFCs

RFCs	Title
No new or modified RFCs are supported by this feature, and support for existing RFCs has not been modified by this feature.	—

Technical Assistance

Description	Link
The Cisco Technical Support website contains thousands of pages of searchable technical content, including links to products, technologies, solutions, technical tips, and tools. Registered Cisco.com users can log in from this page to access even more content.	http://www.cisco.com/techsupport



Implementing IPv6 Multicast

Traditional IP communication allows a host to send packets to a single host (unicast transmission) or to all hosts (broadcast transmission). IPv6 multicast provides a third scheme, allowing a host to send a single data stream to a subset of all hosts (group transmission) simultaneously.

This module describes the concepts and tasks you need to implement IPv6 multicast on your network.

Finding Support Information for Platforms and Cisco IOS Software Images

Use Cisco Feature Navigator to find information about platform support and Cisco IOS software image support. Access Cisco Feature Navigator at <http://www.cisco.com/go/fn>. You must have an account on Cisco.com. If you do not have an account or have forgotten your username or password, click **Cancel** at the login dialog box and follow the instructions that appear.

Contents

- [Prerequisites for IPv6 Multicast, page 305](#)
- [Restrictions for IPv6 Multicast, page 307](#)
- [Information About IPv6 Multicast, page 308](#)
- [How to Implement IPv6 Multicast, page 323](#)
- [Configuration Examples for IPv6 Multicast, page 375](#)
- [Additional References, page 378](#)

Prerequisites for IPv6 Multicast

- In order to enable IPv6 multicast routing on a router, you must first enable IPv6 unicast routing on the router. For information on how to enable IPv6 unicast routing on a router, refer to *Implementing Basic Connectivity for IPv6*.
- You must enable IPv6 unicast routing on all interfaces.
- This module assumes that you are familiar with IPv6 addressing and basic configuration. Refer to the *Implementing Basic Connectivity for IPv6* module for more information.
- This module assumes that you are familiar with IPv4. Refer to the publications referenced in the “[Related Documents](#)” section for IPv4 configuration and command reference information, as needed.

Table 21 identifies the earliest release for each early-deployment release in which the feature became available.

Table 21 Minimum Required Cisco IOS Release

Feature	Minimum Required Cisco IOS Release by Release
IPv6 multicast	12.0(26)S, 12.2(18)S, 12.3(2)T, 12.4, 12.4(2)T, 12.2(28)SB, 12.2(33)SRA
IPv6 address formats	12.2(2)T, 12.0(21)ST, 12.0(22)S, 12.2(14)S, 12.3, 12.3(2)T, 12.4, 12.4(2)T, 12.2(33)SRA
Multicast Listener Discovery (MLD) protocol, Versions 1 and 2	12.0(26)S, 12.2(18)S, 12.3(2)T, 12.4, 12.4(2)T, 12.2(28)SB, 12.2(33)SRA
PIM sparse mode (PIM-SM)	12.0(26)S, 12.2(18)S, 12.3(2)T, 12.4, 12.4(2)T, 12.2(28)SB, 12.2(33)SRA
PIM Source Specific Multicast (PIM-SSM)	12.0(26)S, 12.2(18)S, 12.3(2)T, 12.4, 12.4(2)T, 12.2(28)SB, 12.2(33)SRA
Multicast Routing Information Base (MRIB)	12.0(26)S, 12.2(18)S, 12.3(2)T, 12.4, 12.4(2)T
Multicast Forwarding Information Base (MFIB)	12.0(26)S, 12.2(18)S, 12.3(2)T, 12.4, 12.4(2)T
IPv6 multicast process switching and fast switching	12.0(26)S, 12.2(18)S, 12.3(2)T, 12.4, 12.4(2)T
Multicast scope boundaries	12.0(26)S, 12.2(18)S, 12.3(2)T, 12.4, 12.4(2)T, 12.2(28)SB, 12.2(33)SRA
IPv6 multicast over IPv4 tunnels	12.0(26)S, 12.2(18)S, 12.3(2)T, 12.4, 12.4(2)T
Static RP configuration	12.0(26)S, 12.2(18)S, 12.3(2)T, 12.4, 12.4(2)T
MLD access group	12.0(26)S, 12.3(4)T, 12.2(25)S, 12.4, 12.4(2)T, 12.2(28)SB, 12.2(33)SRA
PIM accept register	12.0(26)S, 12.3(4)T, 12.2(25)S, 12.4, 12.4(2)T, 12.2(28)SB, 12.2(33)SRA
PIM embedded RP support	12.0(26)S, 12.3(4)T, 12.2(25)S, 12.4, 12.4(2)T, 12.2(28)SB, 12.2(33)SRA
RPF flooding of BSR packets	12.0(26)S, 12.3(4)T, 12.2(25)S, 12.4, 12.4(2)T, 12.2(28)SB, 12.2(33)SRA
Routable address hello option	12.0(26)S, 12.3(4)T, 12.2(25)S, 12.4, 12.4(2)T, 12.2(28)SB, 12.2(33)SRA
Static multicast routing (mroute)	12.0(26)S, 12.3(4)T, 12.2(25)S, 12.4, 12.4(2)T, 12.2(28)SB, 12.2(33)SRA
Address family support for multiprotocol BGP	12.0(26)S, 12.3(4)T, 12.4, 12.4(2)T, 12.2(28)SB, 12.2(33)SRA
Distributed MFIB (dMFIB)	12.0(26)S, 12.3(4)T, 12.2(25)S, 12.4, 12.4(2)T, 12.2(28)SB
Explicit tracking of receivers	12.3(7)T, 12.2(25)S, 12.4, 12.4(2)T, 12.2(28)SB, 12.2(33)SRA
IPv6 bidirectional PIM	12.3(7)T, 12.4, 12.4(2)T, 12.2(28)SB, 12.2(33)SRA
MFIB display enhancements	12.3(7)T, 12.4, 12.4(2)T, 12.2(28)SB

Table 21 Minimum Required Cisco IOS Release

Feature	Minimum Required Cisco IOS Release by Release
IPv6 BSR	12.0(28)S, 12.2(25)S, 12.3(11)T, 12.4, 12.4(2)T, 12.2(28)SB, 12.2(33)SRA
IPv6 BSR bidirectional support	12.3(14)T, 12.4, 12.4(2)T
IPv6 BSR scoped-zone support	12.2(18)SXE, 12.2(28)SB, 12.2(28)SB
SSM mapping for MLDv1 SSM	12.2(18)SXE, 12.4(2)T, 12.2(28)SB, 12.2(33)SRA
IPv6 BSR ability to configure RP mapping	12.4(2)T
MLD group limits	12.4(2)T
Multicast user authentication and profile support	12.4(4)T

Restrictions for IPv6 Multicast

- IPv6 multicast for Cisco IOS software uses MLD version 2. This version of MLD is fully backward-compatible with MLD version 1 (described in RFC 2710). Hosts that support only MLD version 1 will interoperate with a router running MLD version 2. Mixed LANs with both MLD version 1 and MLD version 2 hosts are likewise supported.
- IPv6 multicast is supported only over IPv4 tunnels in Cisco IOS Release 12.3(2)T, Cisco IOS Release 12.2(18)S, and Cisco IOS Release 12.0(26)S.
- When using bidirectional (bidir) range in a network, all routers in that network must be able to understand the bidirectional range in the bootstrap message (BSM).

Platform-Specific Information and Restrictions

In Cisco IOS Release 12.0(26)S, IPv6 Multicast is supported on the Cisco 12000 series Internet router only on the following line cards:

- IP Service Engine (ISE):
 - 4-port Gigabit Ethernet ISE
 - 4-port OC-3c/STM-1c POS/SDH ISE
 - 8-port OC-3c/STM-1c POS/SDH ISE
 - 16-port OC-3c/STM-1c POS/SDH ISE
 - 4-port OC-12c/STM-4c POS/SDH ISE
 - 1-port OC-48c/STM-16c POS/SDH ISE
- Engine 4 Plus (E4+) Packet-over-SONET (POS):
 - 4-port OC-48c/STM-16c POS/SDH
 - 1-port OC-192c/STM-64c POS/SDH



Note In future Cisco IOS releases, IPv6 Multicast will be supported on other Cisco 12000 series line cards. IPv6 Multicast will not, however, be supported on the following Cisco 12000 series line cards:

Engine 1:
 - 8-port Fast Ethernet
 - 1-port Gigabit Ethernet

Engine 2:
 - 3-port Gigabit Ethernet

On Cisco 12000 series line cards, the IPv6 multicast feature includes support for Protocol Independent Multicast sparse mode (PIM-SM), Multicast Listener Discovery (MLDv2), static mroutes, and the IPv6 distributed Multicast Forwarding Information Base (MFIB).

Forwarding of IPv6 multicast traffic is hardware-based on Cisco 12000 series IP Service Engine (ISE) line cards that support IPv6 multicast and software-based on all other supported Cisco 12000 series line cards.

On Cisco 12000 series ISE line cards, IPv6 multicast is implemented so that if the number of IPv6 multicast routes exceeds the hardware capacity of the ternary content addressable memory (TCAM), the following error message is displayed to describe how to increase the TCAM hardware capacity for IPv6 multicast routes:

```
EE48-3-IPV6_TCAM_CAPACITY_EXCEEDED: IPv6 multicast pkts will be software switched.
To support more IPv6 multicast routes in hardware:
Get current TCAM usage with: show controllers ISE <slot> tcam
In config mode, reallocate TCAM regions e.g. reallocate Netflow TCAM to IPv6 Mcast
hw-module slot <num> tcam carve rx_ipv6_mcast <v6-mcast-percent>
hw-module slot <num> tcam carve rx_top_nf <nf-percent>
Verify with show command that sum of all TCAM regions = 100%
Reload the linecard for the new TCAM carve config to take effect
WARNING: Recarve may affect other input features (ACL,CAR,MQC,Netflow)
```

TCAM is used for IPv6 multicast forwarding lookups. To increase TCAM capacity for handling IPv6 multicast routes, you must use the **hw-module slot number tcam carve rx_ipv6_mcast v6-mcast-percentage** command in privileged EXEC mode, where *v6-mcast-percentage* specifies the percentage of TCAM hardware used by IPv6 multicast prefix.

For example, you can change the IPv6 multicast region from 1 percent (default) to 16 percent of the TCAM hardware by reallocating the NetFlow region from 35 percent (default) to 20 percent as follows:

```
Router# hw-module slot 3 tcam carve rx_ipv6_mcast 16
Router# hw-module slot 3 tcam carve rx_nf 20
```

IPv6 multicast hardware forwarding is support on the Cisco Catalyst 6500 and 7600 series in Cisco IOS Release 12.2(18)SXE.

Information About IPv6 Multicast

To configure IPv6 multicast, you need to understand the following concepts:

- [IPv6 Multicast Overview, page 309](#)
- [IPv6 Multicast Addressing, page 309](#)
- [IPv6 Multicast Routing Implementation, page 312](#)

- [Multicast Listener Discovery Protocol for IPv6, page 312](#)
- [Protocol Independent Multicast, page 314](#)
- [Static Mroutes, page 321](#)
- [MRIB, page 321](#)
- [MFIB, page 321](#)
- [IPv6 Multicast Process Switching and Fast Switching, page 322](#)
- [Multiprotocol BGP for the IPv6 Multicast Address Family, page 323](#)

IPv6 Multicast Overview

An IPv6 multicast group is an arbitrary group of receivers that want to receive a particular data stream. This group has no physical or geographical boundaries—receivers can be located anywhere on the Internet or in any private network. Receivers that are interested in receiving data flowing to a particular group must join the group by signaling their local router. This signaling is achieved with the MLD protocol.

Routers use the MLD protocol to learn whether members of a group are present on their directly attached subnets. Hosts join multicast groups by sending MLD report messages. The network then delivers data to a potentially unlimited number of receivers, using only one copy of the multicast data on each subnet. IPv6 hosts that wish to receive the traffic are known as group members.

Packets delivered to group members are identified by a single multicast group address. Multicast packets are delivered to a group using best-effort reliability, just like IPv6 unicast packets.

The multicast environment consists of senders and receivers. Any host, regardless of whether it is a member of a group, can send to a group. However, only the members of a group receive the message.

A multicast address is chosen for the receivers in a multicast group. Senders use that address as the destination address of a datagram to reach all members of the group.

Membership in a multicast group is dynamic; hosts can join and leave at any time. There is no restriction on the location or number of members in a multicast group. A host can be a member of more than one multicast group at a time.

How active a multicast group is, its duration, and its membership can vary from group to group and from time to time. A group that has members may have no activity.

IPv6 Multicast Addressing

An IPv6 multicast address is an IPv6 address that has a prefix of FF00::/8 (1111 1111). An IPv6 multicast address is an identifier for a set of interfaces that typically belong to different nodes. A packet sent to a multicast address is delivered to all interfaces identified by the multicast address. The second octet following the prefix defines the lifetime and scope of the multicast address. A permanent multicast address has a lifetime parameter equal to 0; a temporary multicast address has a lifetime parameter equal to 1. A multicast address that has the scope of a node, link, site, or organization, or a global scope has a scope parameter of 1, 2, 5, 8, or E, respectively. For example, a multicast address with the prefix FF02::/16 is a permanent multicast address with a link scope. [Figure 28](#) shows the format of the IPv6 multicast address.

Figure 28 IPv6 Multicast Address Format

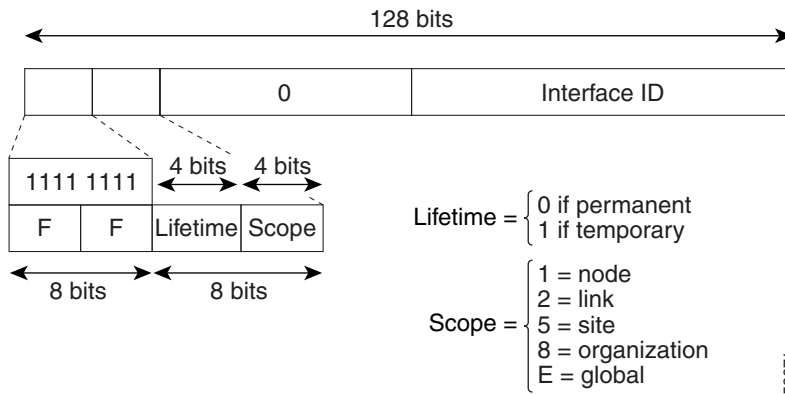

IPv6 nodes (hosts and routers) are required to join (receive packets destined for) the following multicast groups:

- All-nodes multicast group FF02:0:0:0:0:0:0:1 (scope is link-local)
- Solicited-node multicast group FF02:0:0:0:0:1:FF00:0000/104 for each of its assigned unicast and anycast addresses

IPv6 routers must also join the all-routers multicast group FF02:0:0:0:0:0:0:2 (scope is link-local).

The solicited-node multicast address is a multicast group that corresponds to an IPv6 unicast or anycast address. IPv6 nodes must join the associated solicited-node multicast group for every unicast and anycast address to which it is assigned. The IPv6 solicited-node multicast address has the prefix FF02:0:0:0:0:1:FF00:0000/104 concatenated with the 24 low-order bits of a corresponding IPv6 unicast or anycast address (see Figure 29). For example, the solicited-node multicast address corresponding to the IPv6 address 2037::01:800:200E:8C6C is FF02::1:FF0E:8C6C. Solicited-node addresses are used in neighbor solicitation messages.

Figure 29 IPv6 Solicited-Node Multicast Address Format

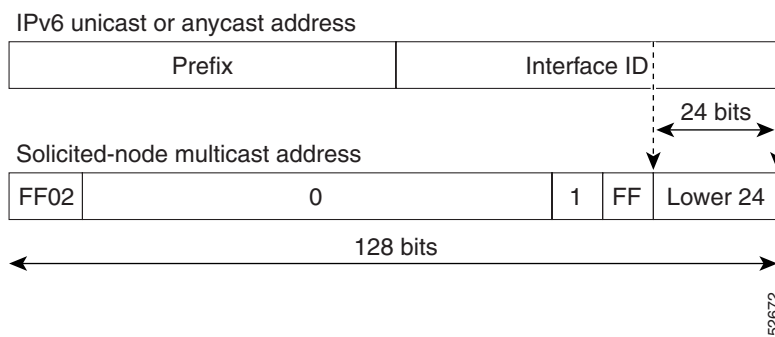

Note

There are no broadcast addresses in IPv6. IPv6 multicast addresses are used instead of broadcast addresses.

IPv6 Multicast Groups

An IPv6 address must be configured on an interface for the interface to forward IPv6 traffic. Configuring a site-local or global IPv6 address on an interface automatically configures a link-local address and activates IPv6 for that interface. Additionally, the configured interface automatically joins the following required multicast groups for that link:

- Solicited-node multicast group FF02:0:0:0:1:FF00::/104 for each unicast and anycast address assigned to the interface
- All-nodes link-local multicast group FF02::1
- All-routers link-local multicast group FF02::2



Note The solicited-node multicast address is used in the neighbor discovery process.

For further information on configuring IPv6 addresses, refer to the *Implementing Basic Connectivity for IPv6* process module.

Scoped Address Architecture

IPv6 includes support for global and nonglobal addresses. This section describes the usage of IPv6 addresses of different scopes.

A scope zone, or a simply a zone, is a connected region of topology of a given scope. For example, the set of links connected by routers within a particular site, and the interfaces attached to those links, comprise a single zone of site-local scope.

A zone is a particular instance of a topological region (for example, Zone1's site or Zone2's site), whereas a scope is the size of a topological region (for example, a site or a link). The zone to which a particular nonglobal address pertains is not encoded in the address itself, but rather is determined by context, such as the interface from which it is sent or received. Therefore, addresses of a given nonglobal scope may be reused in different zones of that scope. For example, Zone1's site and Zone2's site may each contain a node with site-local address FEC0::1.

Zones of the different scopes are instantiated as follows:

- Each link, and the interfaces attached to that link, comprises a single zone of link-local scope (for both unicast and multicast).
- There is a single zone of global scope (for both unicast and multicast), comprising all the links and interfaces in the Internet.
- The boundaries of zones of scope other than interface-local, link-local, and global must be defined and configured by network administrators. A site boundary serves as such for both unicast and multicast.

Zone boundaries are relatively static features and do not change in response to short-term changes in topology. Therefore, the requirement that the topology within a zone be "connected" is intended to include links and interfaces that may be connected only occasionally. For example, a residential node or network that obtains Internet access by dialup to an employer's site may be treated as part of the employer's site-local zone even when the dialup link is disconnected. Similarly, a failure of a router, interface, or link that causes a zone to become partitioned does not split that zone into multiple zones; rather, the different partitions are still considered to belong to the same zone.

Zones have the following additional properties:

specifically which multicast addresses are of interest to those neighboring nodes. It is used for discovering local group and source-specific group membership. The MLD protocol provides a means to automatically control and limit the flow of multicast traffic throughout your network with the use of special multicast queriers and hosts.

The difference between multicast queriers and hosts is as follows:

- A querier is a network device, such as a router, that sends query messages to discover which network devices are members of a given multicast group.
- A host is a receiver, including routers, that send report messages to inform the querier of a host membership.

A set of queriers and hosts that receive multicast data streams from the same source is called a multicast group. Queriers and hosts use MLD reports to join and leave multicast groups and to begin receiving group traffic.

MLD uses the Internet Control Message Protocol (ICMP) to carry its messages. All MLD messages are link-local with a hop limit of 1, and they all have the router alert option set. The router alert option implies an implementation of the hop-by-hop option header.

MLD has three types of messages:

- Query—General, group-specific, and multicast-address-specific. In a query message, the multicast address field is set to 0 when MLD sends a general query. The general query learns which multicast addresses have listeners on an attached link.
Group-specific and multicast-address-specific queries are the same. A group address is a multicast address.
- Report—In a report message, the multicast address field is that of the specific IPv6 multicast address to which the sender is listening.
- Done—In a done message, the multicast address field is that of the specific IPv6 multicast address to which the source of the MLD message is no longer listening.

An MLD report must be sent with a valid IPv6 link-local source address, or the unspecified address (::), if the sending interface has not yet acquired a valid link-local address. Sending reports with the unspecified address is allowed to support the use of IPv6 multicast in the Neighbor Discovery Protocol.

For stateless autoconfiguration, a node is required to join several IPv6 multicast groups in order to perform duplicate address detection (DAD). Prior to DAD, the only address the reporting node has for the sending interface is a tentative one, which cannot be used for communication. Therefore, the unspecified address must be used.

MLD states that result from MLD version 2 or MLD version 1 membership reports can be limited globally or by interface. The MLD group limits feature provides protection against denial of service (DoS) attacks caused by MLD packets. Membership reports in excess of the configured limits will not be entered in the MLD cache, and traffic for those excess membership reports will not be forwarded.

MLD provides support for source filtering. Source filtering allows a node to report interest in listening to packets only from specific source addresses (as required to support SSM), or from all addresses except specific source addresses sent to a particular multicast address.

When a host using MLD version 1 sends a leave message, the router needs to send query messages to reconfirm that this host was the last MLD version 1 host joined to the group before it can stop forwarding traffic. This function takes about 2 seconds. This so-called “leave latency” is also present in IGMP version 2 for IPv4 multicast.

MLD Access Group

The MLD access group provides receiver access control in Cisco IOS IPv6 multicast routers. This feature limits the list of groups a receiver can join, and it allows or denies sources used to join SSM channels.

Explicit Tracking of Receivers

The explicit tracking feature allows a router to track the behavior of the hosts within its IPv6 network. This feature also enables the fast leave mechanism to be used with MLD version 2 host reports.

Multicast User Authentication and Profile Support

IPv6 multicast by design allows any host in the network to become a receiver or a source for a multicast group. Therefore, multicast access control is needed to control multicast traffic in the network. Access control functionality consists mainly of source access control and accounting, receiver access control and accounting, and provisioning of this access control mechanism.

Multicast access control provides an interface between multicast and authentication, authorization, and accounting (AAA) for provisioning, authorizing, and accounting at the last-hop router, receiver access control functions in multicast, and group or channel disabling capability in multicast.

When you deploy a new multicast service environment, it is necessary to add user authentication and provide a user profile download on a per-interface basis. The use of AAA and IPv6 multicast supports user authentication and downloading of the user profile in a multicast environment.

The event that triggers the download of a multicast cast access-control profile from the RADIUS server to the access router is arrival of an MLD join on the access router. When this event occurs, a user can case the authorization cache to time out and request download periodically or use an appropriate multicast clear command to trigger a new download in case of profile changes.

Accounting occurs via RADIUS accounting. Start and stop accounting records are sent to the RADIUS server from the access router. In order for you to track resource consumption on a per-stream basis, these accounting records provide information about the multicast source and group. The start record is sent when the last-hop router receives a new MLD report, and the stop record is sent upon MLD leave or if the group or channel is deleted for any reason.

Protocol Independent Multicast

Protocol Independent Multicast (PIM) is used between routers so that they can track which multicast packets to forward to each other and to their directly connected LANs. PIM works independently of the unicast routing protocol to perform send or receive multicast route updates like other protocols.

Regardless of which unicast routing protocols are being used in the LAN to populate the unicast routing table, Cisco IOS PIM uses the existing unicast table content to perform the Reverse Path Forwarding (RPF) check instead of building and maintaining its own separate routing table.

You can configure IPv6 multicast to use either PIM-SM or PIM-SSM operation, or you can use both PIM-SM and PIM-SSM together in your network.

PIM-Sparse Mode

IPv6 multicast provides support for intradomain multicast routing using PIM-SM. PIM-SM uses unicast routing to provide reverse-path information for multicast tree building, but it is not dependent on any particular unicast routing protocol.

PIM-SM is used in a multicast network when relatively few routers are involved in each multicast and these routers do not forward multicast packets for a group, unless there is an explicit request for the traffic. PIM-SM distributes information about active sources by forwarding data packets on the shared tree. PIM-SM initially uses shared trees, which requires the use of an RP.

Requests are accomplished via PIM joins, which are sent hop by hop toward the root node of the tree. The root node of a tree in PIM-SM is the RP in the case of a shared tree or the first-hop router that is directly connected to the multicast source in the case of a shortest path tree (SPT). The RP keeps track of multicast groups and the hosts that send multicast packets are registered with the RP by that host's first-hop router.

As a PIM join travels up the tree, routers along the path set up multicast forwarding state so that the requested multicast traffic will be forwarded back down the tree. When multicast traffic is no longer needed, a router sends a PIM prune up the tree toward the root node to prune (or remove) the unnecessary traffic. As this PIM prune travels hop by hop up the tree, each router updates its forwarding state appropriately. Ultimately, the forwarding state associated with a multicast group or source is removed.

A multicast data sender sends data destined for a multicast group. The designated router (DR) of the sender takes those data packets, unicast-encapsulates them, and sends them directly to the RP. The RP receives these encapsulated data packets, de-encapsulates them, and forwards them onto the shared tree. The packets then follow the (*, G) multicast tree state in the routers on the RP tree, being replicated wherever the RP tree branches, and eventually reaching all the receivers for that multicast group. The process of encapsulating data packets to the RP is called registering, and the encapsulation packets are called PIM register packets.

Designated Router

Cisco routers use PIM-SM to forward multicast traffic and follow an election process to select a designated router when there is more than one router on a LAN segment.

The designated router is responsible for sending PIM register and PIM join and prune messages toward the RP to inform it about host group membership.

If there are multiple PIM-SM routers on a LAN, a designated router must be elected to avoid duplicating multicast traffic for connected hosts. The PIM router with the highest IPv6 address becomes the DR for the LAN unless you choose to force the DR election by use of the **ipv6 pim dr-priority** command. This command allows you to specify the DR priority of each router on the LAN segment (default priority = 1) so that the router with the highest priority will be elected as the DR. If all routers on the LAN segment have the same priority, then the highest IPv6 address is again used as the tiebreaker.

[Figure 31](#) illustrates what happens on a multiaccess segment. Router A and Router B are connected to a common multiaccess Ethernet segment with Host A as an active receiver for Group A. Only Router A, operating as the DR, sends joins to the RP to construct the shared tree for Group A. If Router B was also permitted to send (*, G) joins to the RP, parallel paths would be created and Host A would receive duplicate multicast traffic. Once Host A begins to source multicast traffic to the group, the DR's responsibility is to send register messages to the RP. If both routers were assigned the responsibility, the RP would receive duplicate multicast packets.

Figure 31 Designated Router Election on a Multiaccess Segment

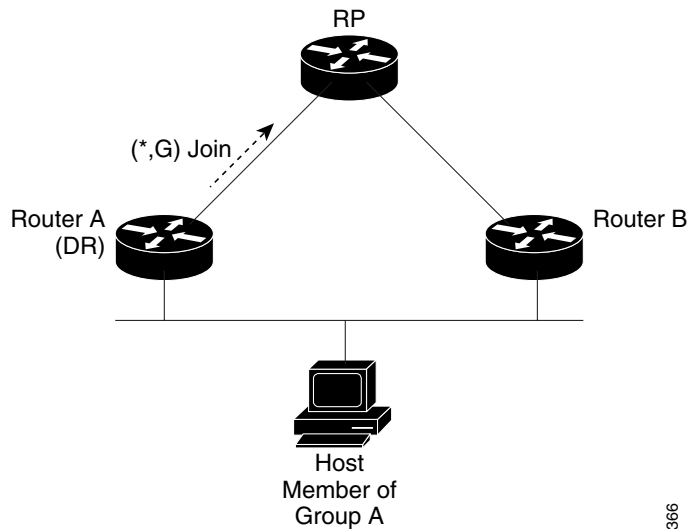

If the DR should fail, the PIM-SM provides a way to detect the failure of Router A and elect a failover DR. If the DR (Router A) became inoperable, Router B would detect this situation when its neighbor adjacency with Router A timed out. Because Router B has been hearing MLD membership reports from Host A, it already has MLD state for Group A on this interface and would immediately send a join to the RP when it became the new DR. This step reestablishes traffic flow down a new branch of the shared tree via Router B. Additionally, if Host A were sourcing traffic, Router B would initiate a new register process immediately after receiving the next multicast packet from Host A. This action would trigger the RP to join the SPT to Host A via a new branch through Router B.



Tips

Two PIM routers are neighbors if there is a direct connection between them. To display your PIM neighbors, use the **show ipv6 pim neighbor** command in privileged EXEC mode.



Note

DR election process is required only on multiaccess LANs. The last-hop router directly connected to the host is the DR.

Rendezvous Point

IPv6 PIM provides embedded RP support. Embedded RP support allows the router to learn RP information using the multicast group destination address instead of the statically configured RP. For routers that are the RP, the router must be statically configured as the RP.

The router searches for embedded RP group addresses in MLD reports or PIM messages and data packets. On finding such an address, the router learns the RP for the group from the address itself. It then uses this learned RP for all protocol activity for the group. For routers that are the RP, the router is advertised as an embedded RP must be configured as the RP.

To select a static RP over an embedded RP, the specific embedded RP group range or mask must be configured in the access list of the static RP. When PIM is configured in sparse mode, you must also choose one or more routers to operate as an RP. An RP is a single common root placed at a chosen point of a shared distribution tree and is configured statically in each box.

PIM DRs forward data from directly connected multicast sources to the RP for distribution down the shared tree. Data is forwarded to the RP in one of two ways:

- Data is encapsulated in register packets and unicast directly to the RP by the first-hop router operating as the DR.
- If the RP has itself joined the source tree, it is multicast-forwarded per the RPF forwarding algorithm described in the “[PIM-Sparse Mode](#)” section.

The RP address is used by first-hop routers to send PIM register messages on behalf of a host sending a packet to the group. The RP address is also used by last-hop routers to send PIM join and prune messages to the RP to inform it about group membership. You must configure the RP address on all routers (including the RP router).

A PIM router can be an RP for more than one group. Only one RP address can be used at a time within a PIM domain for a certain group. The conditions specified by the access list determine for which groups the router is an RP.

IPv6 multicast supports the PIM accept register feature, which is the ability to perform PIM-SM register message filtering at the RP. The user can match an access list or compare the AS path for the registered source with the AS path specified in a route map.

IPv6 BSR

PIM routers in a domain must be able to map each multicast group to the correct RP address. The BSR protocol for PIM-SM provides a dynamic, adaptive mechanism to distribute group-to-RP mapping information rapidly throughout a domain. With the IPv6 BSR feature, if an RP becomes unreachable, it will be detected and the mapping tables will be modified so that the unreachable RP is no longer used, and the new tables will be rapidly distributed throughout the domain.

Every PIM-SM multicast group needs to be associated with the IP or IPv6 address of an RP. When a new multicast sender starts sending, its local DR will encapsulate these data packets in a PIM register message and send them to the RP for that multicast group. When a new multicast receiver joins, its local DR will send a PIM join message to the RP for that multicast group. When any PIM router sends a (*, G) join message, the PIM router needs to know which is the next router toward the RP so that G (Group) can send a message to that router. Also, when a PIM router is forwarding data packets using (*, G) state, the PIM router needs to know which is the correct incoming interface for packets destined for G, because it needs to reject any packets that arrive on other interfaces.

A small set of routers from a domain are configured as candidate bootstrap routers (C-BSRs) and a single BSR is selected for that domain. A set of routers within a domain are also configured as candidate RPs (C-RPs); typically, these routers are the same routers that are configured as C-BSRs. Candidate RPs periodically unicast candidate-RP-advertisement (C-RP-Adv) messages to the BSR of that domain, advertising their willingness to be an RP. A C-RP-Adv message includes the address of the advertising C-RP, and an optional list of group addresses and mask length fields, indicating the group prefixes for which the candidacy is advertised. The BSR then includes a set of these C-RPs, along with their corresponding group prefixes, in bootstrap messages (BSMs) it periodically originates. BSMs are distributed hop-by-hop throughout the domain.

The IPv6 BSR ability to configure RP mapping allows IPv6 multicast routers to be statically configured to announce scope-to-RP mappings directly from the BSR instead of learning them from candidate-RP messages. Announcing RP mappings from the BSR is useful in several situations:

- When an RP address never changes because there is only a single RP or the group range uses an anycast RP, it may be less complex to configure the RP address announcement statically on the candidate BSRs.

- When an RP address is a virtual RP address (such as when using bidirectional PIM), it cannot be learned by the BSR from a candidate-RP. Instead, the virtual RP address must be configured as an announced RP on the candidate BSRs.

Cisco IOS IPv6 routers provide support for the RPF flooding of BSR packets so that a Cisco IOS IPv6 router will not disrupt the flow of BSMs. The router will recognize and parse enough of the BSM to identify the BSR address. The router performs an RPF check for this BSR address and forwards the packet only if it is received on the RPF interface. The router also creates a BSR entry containing RPF information to use for future BSMs from the same BSR. When BSMs from a given BSR are no longer received, the BSR entry is timed out.

Bidirectional BSR support allows bidirectional RPs to be advertised in C-RP messages and bidirectional ranges in the BSM. All routers in a system must be able to use the bidirectional range in the BSM; otherwise, the bidirectional RP feature will not function.

BSR provides scoped zone support by distributing group-to-RP mappings in networks using administratively scoped multicast. The user can configure candidate BSRs and a set of candidate RPs for each administratively scoped region in the user's domain.

For BSR to function correctly with administrative scoping, a BSR and at least one C-RP must be within every administratively scoped region. Administratively scoped zone boundaries must be configured at the zone border routers (ZBRs), because they need to filter PIM join messages that might inadvertently cross the border due to error conditions. In addition, at least one C-BSR within the administratively scoped zone must be configured to be a C-BSR for the administratively scoped zone's address range.

A separate BSR election will then take place (using BSMs) for every administratively scoped range, plus one for the global range. Administratively scoped ranges are identified in the BSM because the group range is marked to indicate that this is an administrative scope range, not just a range that a particular set of RPs is configured to handle.

Unless the C-RP is configured with a scope, it discovers the existence of the administratively scoped zone and its group range through reception of a BSM from the scope zone's elected BSR containing the scope zone's group range. A C-RP stores each elected BSR's address and the administratively scoped range contained in its BSM. It separately unicasts C-RP-Adv messages to the appropriate BSR for every administratively scoped range within which it is willing to serve as an RP.

All PIM routers within a PIM bootstrap domain where administratively scoped ranges are in use must be able to receive BSMs and store the winning BSR and RP set for all administratively scoped zones that apply.

PIM-Source Specific Multicast

PIM-SSM is the routing protocol that supports the implementation of SSM and is derived from PIM-SM. However, unlike PIM-SM where data from all multicast sources are sent when there is a PIM join, the SSM feature forwards datagram traffic to receivers from only those multicast sources that the receivers have explicitly joined, thus optimizing bandwidth utilization and denying unwanted Internet broadcast traffic. Further, instead of the use of RP and shared trees, SSM uses information found on source addresses for a multicast group. This information is provided by receivers through the source addresses relayed to the last-hop routers by MLD membership reports, resulting in shortest-path trees directly to the sources.

In SSM, delivery of datagrams is based on (S, G) channels. Traffic for one (S, G) channel consists of datagrams with an IPv6 unicast source address S and the multicast group address G as the IPv6 destination address. Systems will receive this traffic by becoming members of the (S, G) channel. Signaling is not required, but receivers must subscribe or unsubscribe to (S, G) channels to receive or not receive traffic from specific sources.

MLD version 2 is required for SSM to operate. MLD allows the host to provide source information. Before SSM will run with MLD, SSM must be supported in the Cisco IOS IPv6 router, the host where the application is running, and the application itself.

SSM Mapping for IPv6

SSM mapping for IPv6 supports both static and dynamic Domain Name System (DNS) mapping for MLD version 1 receivers. This feature allows deployment of IPv6 SSM with hosts that are incapable of providing MLD version 2 support in their TCP/IP host stack and their IP multicast receiving application.

SSM mapping allows the router to look up the source of a multicast MLD version 1 report either in the running configuration of the router or from a DNS server. The router can then initiate an (S, G) join toward the source.

PIM Shared Tree and Source Tree (Shortest-Path Tree)

By default, members of a group receive data from senders to the group across a single data distribution tree rooted at the RP. This type of distribution tree is called shared tree or rendezvous point tree (RPT), as illustrated in Figure 32. Data from senders is delivered to the RP for distribution to group members joined to the shared tree.

Figure 32 Shared Tree and Source Tree (Shortest Path Tree)

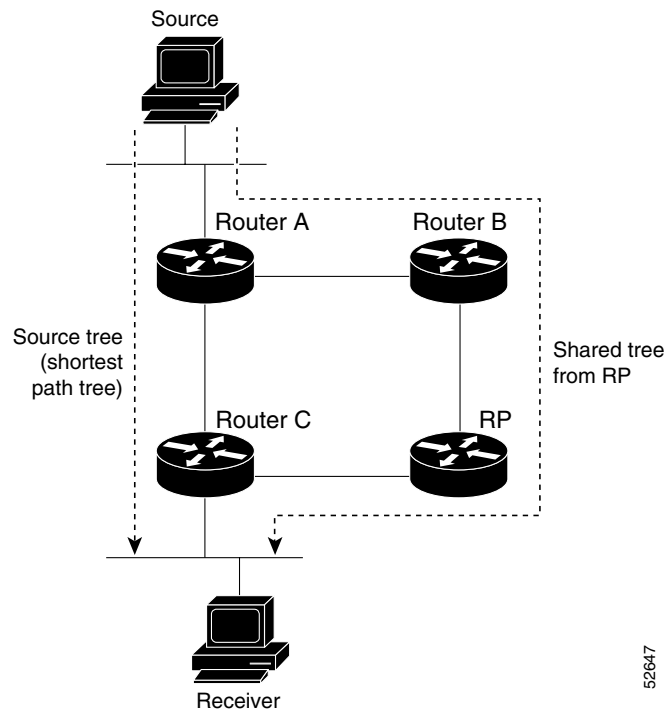

If the data threshold warrants, leaf routers on the shared tree may initiate a switch to the data distribution tree rooted at the source. This type of distribution tree is called a shortest path tree or source tree. By default, the Cisco IOS software switches to a source tree upon receiving the first data packet from a source.

The following process describes the move from shared tree to source tree in more detail:

1. Receiver joins a group; leaf Router C sends a join message toward the RP.

2. RP puts the link to Router C in its outgoing interface list.
3. Source sends the data; Router A encapsulates the data in the register and sends it to the RP.
4. RP forwards the data down the shared tree to Router C and sends a join message toward the source. At this point, data may arrive twice at Router C, once encapsulated and once natively.
5. When data arrives natively (unencapsulated) at the RP, the RP sends a register-stop message to Router A.
6. By default, receipt of the first data packet prompts Router C to send a join message toward the source.
7. When Router C receives data on (S, G), it sends a prune message for the source up the shared tree.
8. RP deletes the link to Router C from the outgoing interface of (S, G).
9. RP triggers a prune message toward the source.

Join and prune messages are sent for sources and RPs. They are sent hop-by-hop and are processed by each PIM router along the path to the source or RP. Register and register-stop messages are not sent hop-by-hop. They are sent by the designated router that is directly connected to a source and are received by the RP for the group.

Reverse Path Forwarding

Reverse-path forwarding is used for forwarding multicast datagrams. It functions as follows:

- If a router receives a datagram on an interface it uses to send unicast packets to the source, the packet has arrived on the RPF interface.
- If the packet arrives on the RPF interface, a router forwards the packet out the interfaces present in the outgoing interface list of a multicast routing table entry.
- If the packet does not arrive on the RPF interface, the packet is silently discarded to prevent loops.

PIM uses both source trees and RP-rooted shared trees to forward datagrams; the RPF check is performed differently for each, as follows:

- If a PIM router has source-tree state (that is, an (S, G) entry is present in the multicast routing table), the router performs the RPF check against the IPv6 address of the source of the multicast packet.
- If a PIM router has shared-tree state (and no explicit source-tree state), it performs the RPF check on the RP's address (which is known when members join the group).

Sparse-mode PIM uses the RPF lookup function to determine where it needs to send joins and prunes. (S, G) joins (which are source-tree states) are sent toward the source. (*, G) joins (which are shared-tree states) are sent toward the RP.

Routable Address Hello Option

When an IPv6 interior gateway protocol is used to build the unicast routing table, the procedure to detect the upstream router address assumes the address of a PIM neighbor is always same as the address of the next-hop router, as long as they refer to the same router. However, it may not be the case when a router has multiple addresses on a link.

Two typical situations can lead to this situation for IPv6. The first situation can occur when the unicast routing table is not built by an IPv6 interior gateway protocol such as multicast BGP. The second situation occurs when the address of an RP shares a subnet prefix with down stream routers (note that the RP router address has to be domain-wide and therefore cannot be a link-local address).

The routable address hello option allows the PIM protocol avoid such situations by adding a PIM hello message option that includes all the addresses on the interface on which the PIM hello message is advertised. When a PIM router finds an upstream router for some address, the result of RPF calculation is compared with the addresses in this option, in addition to PIM neighbor's address itself. Because this option includes all the possible addresses of a PIM router on that link, it always includes the RPF calculation result if it refers to the PIM router supporting this option.

Bidirectional PIM

Bidirectional PIM allows multicast routers to keep reduced state information, as compared with unidirectional shared trees in PIM-SM. Bidirectional shared trees convey data from sources to the RP and distribute them from the RP to the receivers. Unlike PIM-SM, bidirectional PIM does not switch over to the source tree, and there is no register encapsulation of data from the source to the RP.

Bidirectional PIM offers advantages when there are many moderate or low-rate sources. However, the bidirectional source trees have worse delay characteristics than do the source trees built in PIM-SM.

Only static configuration of bidirectional RPs is supported in IPv6.

Static Mroutes

IPv6 static mroutes behave much in the same way as do IPv6 static routes. IPv6 static mroutes share the same database as IPv6 static routes and are implemented by extending static route support. Static mroutes support equal-cost multipath mroutes, and they also support unicast-only static routes.

For further information on IPv6 static routes, see the *Implementing Static Routes for IPv6* module.

MRIB

The Multicast Routing Information Base (MRIB) is a protocol-independent repository of multicast routing entries instantiated by multicast routing protocols (routing clients). Its main function is to provide independence between routing protocols and the Multicast Forwarding Information Base (MFIB). It also acts as a coordination and communication point among its clients.

Routing clients use the services provided by the MRIB to instantiate routing entries and retrieve changes made to routing entries by other clients. Besides routing clients, MRIB also has forwarding clients (MFIB instances) and special clients such as MLD. MFIB retrieves its forwarding entries from MRIB and notifies the MRIB of any events related to packet reception. These notifications can either be explicitly requested by routing clients or spontaneously generated by the MFIB.

Another important function of the MRIB is to allow for the coordination of multiple routing clients in establishing multicast connectivity within the same multicast session. MRIB also allows for the coordination between MLD and routing protocols.

MFIB

The MFIB is a platform-independent and routing-protocol-independent library for IPv6 software. Its main purpose is to provide a Cisco IOS platform with an interface with which to read the IPv6 multicast forwarding table and notifications when the forwarding table changes. The information provided by the MFIB has clearly defined forwarding semantics and is designed to make it easy for the platform to translate to its specific hardware or software forwarding mechanisms.

When routing or topology changes occur in the network, the IPv6 routing table is updated, and those changes are reflected in the MFIB. The MFIB maintains next-hop address information based on the information in the IPv6 routing table. Because there is a one-to-one correlation between MFIB entries and routing table entries, the MFIB contains all known routes and eliminates the need for route cache maintenance that is associated with switching paths such as fast switching and optimum switching.

Distributed MFIB

Distributed MFIB (dMFIB) is used to switch multicast IPv6 packets on distributed platforms. dMFIB may also contain platform-specific information on replication across line cards. The basic MFIB routines that implement the core of the forwarding logic are common to all forwarding environments.

dMFIB implements the following functionalities:

- Distributes a copy of the MFIB to the line cards.
- Relays data-driven protocol events generated in the line cards to PIM.
- Provides an MFIB platform application program interface (API) to propagate MFIB changes to platform-specific code responsible for programming the hardware acceleration engine. This API also includes entry points to switch a packet in software (necessary if the packet is triggering a data-driven event) and to upload traffic statistics to the software.
- Provides hooks to allow clients residing on the RP to read traffic statistics on demand. (dMFIB does not periodically upload these statistics to the RP.)

The combination of dMFIB and MRIB subsystems also allows the router to have a “customized” copy of the MFIB database in each line card and to transport MFIB-related platform-specific information from the RP to the line cards.

IPv6 Multicast Process Switching and Fast Switching

A unified MFIB is used to provide both fast switching and process switching support for PIM-SM and PIM-SSM in IPv6 multicast. In process switching, the Route Processor must examine, rewrite, and forward each packet. The packet is first received and copied into the system memory. The router then looks up the Layer 3 network address in the routing table. The Layer 2 frame is then rewritten with the next-hop destination address and sent to the outgoing interface. The RP also computes the cyclic redundancy check (CRC). This switching method is the least scalable method for switching IPv6 packets.

IPv6 multicast fast switching allows routers to provide better packet forwarding performance than process switching. Information conventionally stored in a route cache is stored in several data structures for IPv6 multicast switching. The data structures provide optimized lookup for efficient packet forwarding.

In IPv6 multicast forwarding, the first packet is fast-switched if the PIM protocol logic allows it. Also in IPv6 multicast fast switching, the MAC encapsulation header is precomputed. IPv6 multicast fast switching uses the MFIB to make IPv6 destination prefix-based switching decisions. In addition to the MFIB, IPv6 multicast fast switching uses adjacency tables to prepend Layer 2 addressing information. The adjacency table maintains Layer 2 next-hop addresses for all MFIB entries.

The adjacency table is populated as adjacencies are discovered. Each time an adjacency entry is created (such as through the ARP protocol), a link-layer header for that adjacent node is precomputed and stored in the adjacency table. Once a route is determined, it points to a next hop and corresponding adjacency entry. It is subsequently used for encapsulation during switching of packets.

A route might have several paths to a destination prefix, such as when a router is configured for simultaneous load balancing and redundancy. For each resolved path, a pointer is added for the adjacency corresponding to the next-hop interface for that path. This mechanism is used for load balancing across several paths.

Multiprotocol BGP for the IPv6 Multicast Address Family

The multicast BGP for the IPv6 multicast address family feature provides multicast BGP extensions for IPv6 and supports the same features and functionality as IPv4 BGP. IPv6 enhancements to multicast BGP include support for an IPv6 multicast address family and network layer reachability information (NLRI) and next hop (the next router in the path to the destination) attributes that use IPv6 addresses.

Multicast BGP is an enhanced BGP that allows the deployment of interdomain IPv6 multicast. Multicast BGP carries routing information for multiple network layer protocol address families; for example, IPv6 address family and for IPv6 multicast routes. The IPv6 multicast address family contains routes used for RPF lookup by the IPv6 PIM protocol, and multicast BGP IPv6 provides for interdomain transport of the same. Users must use multicast BGP for IPv6 multicast when using IPv6 multicast with BGP because the unicast multicast BGP learned routes will not be used for IPv6 multicast.

Multicast BGP functionality provided through a separate address family context. A subsequent address family identifier (SAFI) provides information about the type of the network layer reachability information that is carried in the attribute. Multiprotocol BGP unicast uses SAFI 1 messages, and multiprotocol BGP multicast uses SAFI 2 messages.

A separate BGP routing table is maintained to configure incongruent policies and topologies (for example, IPv6 unicast and multicast) by using IPv6 multicast RPF lookup. Multicast RPF lookup is very similar to the IP unicast route lookup.

No MRIB is associated with the IPv6 multicast BGP table. However, IPv6 multicast BGP operates on the unicast IPv6 RIB when needed. Multicast BGP does not insert or update routes into the IPv6 unicast RIB.

How to Implement IPv6 Multicast

The tasks in the following sections explain how to implement IPv6 multicast:

- [Enabling IPv6 Multicast Routing, page 324](#)
- [Configuring the MLD Protocol, page 324](#)
- [Configuring PIM, page 335](#)
- [Configuring a BSR, page 342](#)
- [Configuring SSM Mapping, page 346](#)
- [Configuring Static Mroutes, page 347](#)
- [Configuring IPv6 Multiprotocol BGP, page 349](#)
- [Using MFIB in IPv6 Multicast, page 358](#)
- [Disabling Default Features in IPv6 Multicast, page 360](#)
- [Troubleshooting IPv6 Multicast, page 365](#)

Enabling IPv6 Multicast Routing

This task explains how to enable IPv6 multicast routing on all interfaces and to enable multicast forwarding for PIM and MLD on all enabled interfaces of the router.

Prerequisites

In order to enable IPv6 multicast routing on a router, you must first enable IPv6 unicast routing on the router. For information on how to enable IPv6 unicast routing on a router, refer to *Implementing Basic Connectivity for IPv6*.

If you are already using an IPv6 unicast router, use the following tasks to enable IPv6 multicast routing and configure IPv6 multicast routing options.

SUMMARY STEPS

1. **enable**
2. **configure terminal**
3. **ipv6 multicast-routing**

DETAILED STEPS

	Command or Action	Purpose
Step 1	enable Example: Router> enable	Enables privileged EXEC mode. <ul style="list-style-type: none"> • Enter your password if prompted.
Step 2	configure terminal Example: Router# configure terminal	Enters global configuration mode.
Step 3	ipv6 multicast-routing Example: Router(config)# ipv6 multicast-routing	Enables multicast routing on all IPv6-enabled interfaces and enables multicast forwarding for PIM and MLD on all enabled interfaces of the router.

Configuring the MLD Protocol

The following tasks describe how to customize and verify the MLD protocol.

- [Customizing and Verifying MLD on an Interface, page 325](#)
- [Implementing MLD Group Limits, page 328](#)
- [Configuring Explicit Tracking of Receivers to Track Host Behavior, page 330](#)
- [Configuring Multicast User Authentication and Profile Support, page 331](#)
- [Resetting the MLD Traffic Counters, page 334](#)
- [Clearing the MLD Interface Counters, page 335](#)

Customizing and Verifying MLD on an Interface

Use the following tasks to customize MLD and verify MLD information on each interface, if desired.

SUMMARY STEPS

1. **enable**
2. **configure terminal**
3. **interface** *type number*
4. **ipv6 mld join-group** [*group-name* | *group-address*] [[**include** | **exclude**] *source-address* | *source-name*]
5. **ipv6 mld access-group** *access-list-name*
6. **ipv6 mld static-group** [*group-name* | *group-address*] [[**include** | **exclude**] *source-address* | *source-name*]
7. **ipv6 mld query-max-response-time** *seconds*
8. **ipv6 mld query-timeout** *seconds*
9. **ipv6 mld query-interval** *seconds*
10. **exit**
11. **show ipv6 mld groups** [**link-local**] [*group-name* | *group-address*] [*interface-type* | *interface-number*] [**detail** | **explicit**]
12. **show ipv6 mld groups summary**
13. **show ipv6 mld interface** [*type number*]

DETAILED STEPS

	Command or Action	Purpose
Step 1	enable Example: Router> enable	Enables privileged EXEC mode. <ul style="list-style-type: none"> • Enter your password if prompted.
Step 2	configure terminal Example: Router# configure terminal	Enters global configuration mode.
Step 3	interface <i>type number</i> Example: Router(config)# interface FastEthernet 1/0	Specifies an interface type and number, and places the router in interface configuration mode.

	Command or Action	Purpose
Step 4	<pre>ipv6 mld join-group [group-name group-address] [[include exclude] source-address source-name]</pre> <p>Example: Router(config-if)# ipv6 mld join-group FF04::12 exclude 2001:0DB8::10::11 </p>	Configures MLD reporting for a specified group and source.
Step 5	<pre>ipv6 mld access-group access-list-name</pre> <p>Example: Router(config-if)# ipv6 access-list acc-grp-1 </p>	Allows the user to perform IPv6 multicast receiver access control.
Step 6	<pre>ipv6 mld static-group [group-name group-address] [[include exclude] source-address source-name]</pre> <p>Example: Router(config-if)# ipv6 mld static-group ff04::10 include 100::1 </p>	Statically forwards traffic for the multicast group onto a specified interface and cause the interface to behave as if a MLD joiner were present on the interface.
Step 7	<pre>ipv6 mld query-max-response-time seconds</pre> <p>Example: Router(config-if)# ipv6 mld query-max-response-time 20 </p>	Configures the maximum response time advertised in MLD queries.
Step 8	<pre>ipv6 mld query-timeout seconds</pre> <p>Example: Router(config-if)# ipv6 mld query-timeout 130 </p>	Configures the timeout value before the router takes over as the querier for the interface.
Step 9	<pre>ipv6 mld query-interval seconds</pre> <p>Example: Router(config-if)# ipv6 mld query-interval 60 </p>	Configures the frequency at which the Cisco IOS software sends MLD host-query messages.
Step 10	<pre>exit</pre> <p>Example: Router(config-if)# exit </p>	Enter this command twice to exit interface configuration mode and enter privileged EXEC mode.
Step 11	<pre>show ipv6 mld groups [link-local] [group-name group-address] [interface-type interface-number] [detail explicit]</pre> <p>Example: Router# show ipv6 mld groups FastEthernet 2/1 </p>	Displays the multicast groups that are directly connected to the router and that were learned through MLD.



Caution Changing this value may severely impact multicast forwarding.

	Command or Action	Purpose
Step 12	<pre>show ipv6 mld groups summary</pre> <p>Example: Router# show ipv6 mld groups summary</p>	Displays the number of (*, G) and (S, G) membership reports present in the MLD cache.
Step 13	<pre>show ipv6 mld interface [type number]</pre> <p>Example: Router# show ipv6 mld interface FastEthernet 2/1</p>	Displays multicast-related information about an interface.

Implementing MLD Group Limits

Per-interface and global MLD limits operate independently of each other. Both per-interface and global MLD limits can be configured on the same router. The number of MLD limits, globally or per interface, is not configured by default; the limits must be configured by the user. A membership report that exceeds either the per-interface or the global state limit is ignored.

The following tasks describe how to limit MLD states that result from MLD version 2 or MLD version 1 membership reports globally or per interface:

- [Implementing MLD Group Limits Globally, page 328](#)
- [Clearing the MLD Interface Counters, page 335](#)

Implementing MLD Group Limits Globally

This task describes how to limit MLD groups globally.

SUMMARY STEPS

1. **enable**
2. **configure terminal**
3. **ipv6 mld state-limit *number***

DETAILED STEPS

	Command or Action	Purpose
Step 1	enable Example: Router> enable	Enables privileged EXEC mode. <ul style="list-style-type: none"> • Enter your password if prompted.
Step 2	configure terminal Example: Router# configure terminal	Enters global configuration mode.
Step 3	ipv6 mld state-limit <i>number</i> Example: Router(config)# ipv6 mld state-limit 300	Limits the number of MLD states globally.

Implementing MLD Group Limits per Interface

This task describes how to limit MLD groups on a per-interface basis.

SUMMARY STEPS

1. **enable**
2. **configure terminal**
3. **interface *type number***
4. **ipv6 mld limit *number* [except *access-list*]**

DETAILED STEPS

	Command or Action	Purpose
Step 1	enable Example: Router> enable	Enables privileged EXEC mode. <ul style="list-style-type: none"> • Enter your password if prompted.
Step 2	configure terminal Example: Router# configure terminal	Enters global configuration mode.

	Command or Action	Purpose
Step 3	interface <i>type number</i> Example: Router(config)# interface FastEthernet 1/0	Specifies an interface type and number, and places the router in interface configuration mode.
Step 4	ipv6 mld limit <i>number</i> [except <i>access-list</i>] Example: Router(config-if)# ipv6 mld limit 100	Limits the number of MLD states on a per-interface basis.

Configuring Explicit Tracking of Receivers to Track Host Behavior

This task enables the explicit tracking of receivers feature. The explicit tracking feature allows a router to track the behavior of the hosts within its IPv6 network and enables the fast leave mechanism to be used with MLD version 2 host reports.

SUMMARY STEPS

1. **enable**
2. **configure terminal**
3. **interface** *type number*
4. **ipv6 mld explicit-tracking** *access-list-name*

DETAILED STEPS

	Command or Action	Purpose
Step 1	enable Example: Router> enable	Enables privileged EXEC mode. <ul style="list-style-type: none"> • Enter your password if prompted.
Step 2	configure terminal Example: Router# configure terminal	Enters global configuration mode.
Step 3	interface <i>type number</i> Example: Router(config)# interface FastEthernet 1/0	Specifies an interface type and number, and places the router in interface configuration mode.
Step 4	ipv6 mld explicit-tracking <i>access-list-name</i> Example: Router(config-if)# ipv6 mld explicit-tracking list1	Enables explicit tracking of hosts.

Configuring Multicast User Authentication and Profile Support

This section describes several tasks used to enable and configure the multicast user authentication and profile support feature.

Prerequisites

Before you configure multicast user authentication and profile support, you may configure the following receiver access control functions in IPv6 multicast.

- To limit MLD groups globally, see the [“Implementing MLD Group Limits Globally”](#) section on page 328.
- To limit MLD groups on a per-interface basis, see the [“Implementing MLD Group Limits per Interface”](#) section on page 329
- To specify the MLD groups and sources allowed on an interface, see the [“Customizing and Verifying MLD on an Interface”](#) section on page 325, step 5.

Restrictions

- The port, interface, VC, or VLAN ID is the user or subscriber identity. User identity by hostname, user ID or password is not supported.

To configure multicast user authentication and profile support, perform the following tasks:

- [Enabling AAA Access Control for IPv6 Multicast, page 331](#)
- [Specifying Method Lists and Enabling Multicast Accounting, page 332](#)
- [Disabling the Router from Receiving Unauthenticated Multicast Traffic, page 333](#)
- [Resetting Authorization Status on an MLD Interface, page 334](#)

Enabling AAA Access Control for IPv6 Multicast

The following task describes how to enable AAA access control.

SUMMARY STEPS

1. **enable**
2. **configure terminal**
3. **aaa new-model**

DETAILED STEPS

	Command or Action	Purpose
Step 1	enable Example: Router> enable	Enables privileged EXEC mode. <ul style="list-style-type: none"> Enter your password if prompted.
Step 2	configure terminal Example: Router# configure terminal	Enters global configuration mode.
Step 3	aaa new-model Example: Router(config)# aaa new-model	Enables the AAA access control system.

Specifying Method Lists and Enabling Multicast Accounting

The following task describes how to specify the method lists used for AAA authorization and accounting and how to enable multicast accounting on specified groups or channels on an interface.

SUMMARY STEPS

- enable**
- configure terminal**
- aaa authorization multicast default** [*method3* | *method4*]
- aaa accounting multicast default** [**start-stop** | **stop-only**] [**broadcast**] [*method1*] [*method2*] [*method3*] [*method4*]
- interface** *type number*
- ipv6 multicast aaa account receive** *access-list-name* [**throttle** *throttle-number*]

DETAILED STEPS

	Command or Action	Purpose
Step 1	enable Example: Router> enable	Enables privileged EXEC mode. <ul style="list-style-type: none"> Enter your password if prompted.
Step 2	configure terminal Example: Router# configure terminal	Enters global configuration mode.

	Command or Action	Purpose
Step 3	<pre>aaa authorization multicast default [method3 method4]</pre> <p>Example: Router(config)# aaa authorization multicast default</p>	Enables AAA authorization and sets parameters that restrict user access to an IPv6 multicast network.
Step 4	<pre>aaa accounting multicast default [start-stop stop-only] [broadcast] [method1] [method2] [method3] [method4]</pre> <p>Example: Router(config)# aaa accounting multicast default</p>	Enables AAA accounting of IPv6 multicast services for billing or security purposes when you use RADIUS.
Step 5	<pre>interface type number</pre> <p>Example: Router(config)# interface FastEthernet 1/0</p>	Specifies an interface type and number, and places the router in interface configuration mode.
Step 6	<pre>ipv6 multicast aaa account receive access-list-name [throttle throttle-number]</pre> <p>Example: Router(config-if)# ipv6 multicast aaa account receive list1</p>	Enables AAA accounting on specified groups or channels.

In some situations, access control may be needed to prevent multicast traffic from being received unless the subscriber is authenticated and the channels are authorized as per access control profiles. That is, there should be no traffic at all unless specified otherwise by access control profiles.

Disabling the Router from Receiving Unauthenticated Multicast Traffic

The following task describes how to disable the router from receiving multicast traffic to be received from unauthenticated groups or unauthorized channels.

SUMMARY STEPS

1. **enable**
2. **configure terminal**
3. **ipv6 multicast group-range** [*access-list-name*]

DETAILED STEPS

	Command or Action	Purpose
Step 1	enable Example: Router> enable	Enables privileged EXEC mode. <ul style="list-style-type: none"> Enter your password if prompted.
Step 2	configure terminal Example: Router# configure terminal	Enters global configuration mode.
Step 3	ipv6 multicast group-range [<i>access-list-name</i>] Example: Router(config)# ipv6 multicast group-range	Disables multicast protocol actions and traffic forwarding for unauthorized groups or channels on all the interfaces in a router.

Resetting Authorization Status on an MLD Interface

The following task shows how to reset the authorization status of an interface. If no interface is specified, authorization is reset on all MLD interfaces.

SUMMARY STEPS

- enable
- clear ipv6 multicast aaa authorization [*interface-type interface-number*]

DETAILED STEPS

	Command or Action	Purpose
Step 1	enable Example: Router> enable	Enables privileged EXEC mode. <ul style="list-style-type: none"> Enter your password if prompted.
Step 2	clear ipv6 multicast aaa authorization [<i>interface-type interface-number</i>] Example: Router# clear ipv6 multicast aaa authorization FastEthernet 1/0	Clears parameters that restrict user access to an IPv6 multicast network.

Resetting the MLD Traffic Counters

This task explains how to reset the MLD traffic counters and verify MLD traffic information.

SUMMARY STEPS

- enable

2. `clear ipv6 mld traffic`
3. `show ipv6 mld traffic`

DETAILED STEPS

	Command or Action	Purpose
Step 1	<code>enable</code> Example: Router> <code>enable</code>	Enables privileged EXEC mode. <ul style="list-style-type: none"> • Enter your password if prompted.
Step 2	<code>clear ipv6 mld traffic</code> Example: Router# <code>clear ipv6 mld traffic</code>	Resets all MLD traffic counters.
Step 3	<code>show ipv6 mld traffic</code> Example: Router# <code>show ipv6 mld traffic</code>	Displays the MLD traffic counters.

Clearing the MLD Interface Counters

This task explains how to clear MLD interface counters.

SUMMARY STEPS

1. `enable`
2. `clear ipv6 mld counters [interface-type]`

DETAILED STEPS

	Command or Action	Purpose
Step 1	<code>enable</code> Example: Router> <code>enable</code>	Enables privileged EXEC mode. <ul style="list-style-type: none"> • Enter your password if prompted.
Step 2	<code>clear ipv6 mld counters [interface-type]</code> Example: Router# <code>clear ipv6 mld counters Ethernet1/0</code>	Clears the MLD interface counters.

Configuring PIM

The following tasks explains how to configure PIM-SM and display PIM-SM configuration and information.

- [Configuring PIM-SM and Displaying PIM-SM Information for a Group Range](#), page 336
- [Configuring PIM Options](#), page 337
- [Configuring Bidirectional PIM and Displaying Bidirectional PIM Information](#), page 339
- [Resetting the PIM Traffic Counters](#), page 340
- [Clearing the PIM Topology Table to Reset the MRIB Connection](#), page 341

Configuring PIM-SM and Displaying PIM-SM Information for a Group Range

This task explains how to configure PIM-SM and display PIM-SM configuration and information.

SUMMARY STEPS

1. **enable**
2. **configure terminal**
3. **ipv6 pim rp-address** *ipv6-address* [*group-access-list*] [**bidir**]
4. **exit**
5. **show ipv6 pim interface** [**state-on**] [**state-off**] [*type number*]
6. **show ipv6 pim group-map** [*group-name* | *group-address*] | [*group-range* | *group-mask*] [**info-source** {**bsr** | **default** | **embedded-rp** | **static**}]
7. **show ipv6 pim neighbor** [**detail**] [*interface-type interface-number* | **count**]
8. **show ipv6 pim range-list** [**config**] [*rp-address* | *rp-name*]
9. **show ipv6 pim tunnel** [*interface-type interface-number*]

DETAILED STEPS

	Command or Action	Purpose
Step 1	enable Example: Router> enable	Enables privileged EXEC mode. <ul style="list-style-type: none">• Enter your password if prompted.
Step 2	configure terminal Example: Router# configure terminal	Enters global configuration mode.
Step 3	ipv6 pim rp-address <i>ipv6-address</i> [<i>group-access-list</i>] [bidir] Example: Router(config)# ipv6 pim rp-address 2001:0DB8::01:800:200E:8C6C acc-grp-1	Configures the address of a PIM RP for a particular group range.
Step 4	exit Example: Router(config-if)# exit	Exits global configuration mode, and returns the router to privileged EXEC mode.

	Command or Action	Purpose
Step 5	<pre>show ipv6 pim interface [state-on] [state-off] [type number]</pre> <p>Example: Router# show ipv6 pim interface</p>	Displays information about interfaces configured for PIM.
Step 6	<pre>show ipv6 pim group-map [group-name group-address] [group-range group-mask] [info-source {bsr default embedded-rp static}]</pre> <p>Example: Router# show ipv6 pim group-map</p>	Displays an IPv6 multicast group mapping table.
Step 7	<pre>show ipv6 pim neighbor [detail] [interface-type interface-number count]</pre> <p>Example: Router# show ipv6 pim neighbor</p>	Displays the PIM neighbors discovered by the Cisco IOS software.
Step 8	<pre>show ipv6 pim range-list [config] [rp-address rp-name]</pre> <p>Example: Router# show ipv6 pim range-list</p>	Displays information about IPv6 multicast range lists.
Step 9	<pre>show ipv6 pim tunnel [interface-type interface-number]</pre> <p>Example: Router# show ipv6 pim tunnel</p>	Displays information about the PIM register encapsulation and de-encapsulation tunnels on an interface.

Configuring PIM Options

The following task explains commands you can use to refine your configuration for PIM-SM and PIM-SSM, both in general or on specified interfaces. The task also gives various commands that can be used to verify PIM configuration and information.

SUMMARY STEPS

1. **enable**
2. **configure terminal**
3. **ipv6 pim spt-threshold infinity [group-list access-list-name]**
4. **ipv6 pim accept-register {list access-list | route-map map-name }**
5. **interface type number**
6. **ipv6 pim dr-priority value**
7. **ipv6 pim hello-interval seconds**
8. **ipv6 pim join-prune-interval seconds**
9. **exit**
10. **show ipv6 pim join-prune statistic [interface-type]**

DETAILED STEPS

	Command or Action	Purpose
Step 1	<p>enable</p> <p>Example: Router> enable</p>	<p>Enables privileged EXEC mode.</p> <ul style="list-style-type: none"> Enter your password if prompted.
Step 2	<p>configure terminal</p> <p>Example: Router# configure terminal</p>	<p>Enters global configuration mode.</p>
Step 3	<p>ipv6 pim spt-threshold infinity [group-list access-list-name]</p> <p>Example: Router(config)# ipv6 pim spt-threshold infinity group-list acc-grp-1</p>	<p>Configures when a PIM leaf router joins the SPT for the specified groups.</p>
Step 4	<p>ipv6 pim accept-register {list access-list route-map map-name}</p> <p>Example: Router(config)# ipv6 pim accept-register route-map reg-filter</p>	<p>Accepts or rejects registers at the RP.</p>
Step 5	<p>interface type number</p> <p>Example: Router(config)# interface FastEthernet 1/0</p>	<p>Specifies an interface type and number, and places the router in interface configuration mode.</p>
Step 6	<p>ipv6 pim dr-priority value</p> <p>Example: Router(config-if)# ipv6 pim dr-priority 3</p>	<p>Configures the DR priority on a PIM router.</p>
Step 7	<p>ipv6 pim hello-interval seconds</p> <p>Example: Router(config-if)# ipv6 pim hello-interval 45</p>	<p>Configures the frequency of PIM hello messages on an interface.</p>
Step 8	<p>ipv6 pim join-prune-interval seconds</p> <p>Example: Router(config-if)# ipv6 pim join-prune-interval 75</p>	<p>Configures periodic join and prune announcement intervals for a specified interface.</p>

	Command or Action	Purpose
Step 9	exit Example: Router(config-if)# exit	Enter this command twice to exit interface configuration mode and enter privileged EXEC mode.
Step 10	show ipv6 pim join-prune statistic [<i>interface-type</i>] Example: Router# show ipv6 pim join-prune statistic	Displays the average join-prune aggregation for the most recently aggregated 1000, 10,000, and 50,000 packets for each interface.

Configuring Bidirectional PIM and Displaying Bidirectional PIM Information

This task explains how to configure bidirectional PIM and use **show** commands to display bidirectional PIM information.

SUMMARY STEPS

1. **enable**
2. **configure terminal**
3. **ipv6 pim rp-address** *ipv6-address* [*group-access-list*] [**bidir**]
4. **exit**
5. **show ipv6 pim df** [*interface-type interface-number*] [*rp-address*]
6. **show ipv6 pim df winner** [*interface-type interface-number*] [*rp-address*]

DETAILED STEPS

	Command or Action	Purpose
Step 1	enable Example: Router> enable	Enables privileged EXEC mode. <ul style="list-style-type: none"> • Enter your password if prompted.
Step 2	configure terminal Example: Router# configure terminal	Enters global configuration mode.
Step 3	ipv6 pim rp-address <i>ipv6-address</i> [<i>group-access-list</i>] [bidir] Example: Router(config)# ipv6 pim rp-address 2001:0DB8::01:800:200E:8C6C bidir	Configures the address of a PIM RP for a particular group range. Use of the bidir keyword means that the group range will be used for bidirectional shared-tree forwarding.

	Command or Action	Purpose
Step 4	exit Example: Router(config-if)# exit	Exits global configuration mode, and returns the router to privileged EXEC mode.
Step 5	show ipv6 pim df [<i>interface-type</i> <i>interface-number</i>] [<i>rp-address</i>] Example: Router# show ipv6 pim df	Displays the designated forwarder (DF)-election state of each interface for RP.
Step 6	show ipv6 pim df winner [<i>interface-type</i> <i>interface-number</i>] [<i>rp-address</i>] Example: Router# show ipv6 pim df winner ethernet 1/0 200::1	Displays the DF-election winner on each interface for each RP.

Resetting the PIM Traffic Counters

If PIM malfunctions or in order to verify that the expected number of PIM packets are received and sent, the user can clear PIM traffic counters. Once the traffic counters are cleared, the user can enter the **show ipv6 pim traffic** command to verify that PIM is functioning correctly and that PIM packets are being received and sent correctly.

This task explains how to reset the PIM traffic counters and verify PIM traffic information.

SUMMARY STEPS

1. **enable**
2. **clear ipv6 pim counters**
3. **show ipv6 pim traffic**

DETAILED STEPS

	Command or Action	Purpose
Step 1	enable Example: Router> enable	Enables privileged EXEC mode. <ul style="list-style-type: none"> • Enter your password if prompted.
Step 2	clear ipv6 pim counters Example: Router# clear ipv6 pim counters	Resets the PIM traffic counters.
Step 3	show ipv6 pim traffic Example: Router# show ipv6 pim traffic	Displays the PIM traffic counters.

Clearing the PIM Topology Table to Reset the MRIB Connection

No configuration is necessary to use the MRIB. However, users may in certain situations want to clear the PIM topology table in order to reset the MRIB connection, and verify MRIB information.

SUMMARY STEPS

1. **enable**
2. **clear ipv6 pim topology** [*group-name* | *group-address*]
3. **show ipv6 mrib client** [**filter**] [**name** {*client-name* | *client-name:client-id*}]
4. **show ipv6 mrib route** [**link-local** | **summary** | *source-address* | *source-name* | *] [*group-name* | *group-address* [*prefix-length*]]
5. **show ipv6 pim topology** [**link-local** | **route-count** | *group-name* | *group-address*] [*source-address* | *source-name*]

DETAILED STEPS

	Command or Action	Purpose
Step 1	enable Example: Router> enable	Enables privileged EXEC mode. <ul style="list-style-type: none">• Enter your password if prompted.
Step 2	clear ipv6 pim topology [<i>group-name</i> <i>group-address</i>] Example: Router# clear ipv6 pim topology FF04::10	Clears the PIM topology table.
Step 3	show ipv6 mrib client [filter] [name { <i>client-name</i> <i>client-name:client-id</i> }] Example: Router# show ipv6 mrib client	Displays multicast-related information about an interface.
Step 4	show ipv6 mrib route [link-local summary <i>source-address</i> <i>source-name</i> *] [<i>group-name</i> <i>group-address</i> [<i>prefix-length</i>]] Example: Router# show ipv6 mrib route	Displays the MRIB route information.
Step 5	show ipv6 pim topology [link-local route-count <i>group-name</i> <i>group-address</i>] [<i>source-address</i> <i>source-name</i>] Example: Router# show ipv6 pim topology	Displays PIM topology table information for a specific group or all groups.

Configuring a BSR

The following tasks explain how to perform BSR configuration and to verify BSR configuration and information:

- [Configuring a BSR and Verifying BSR Information, page 342](#)
- [Sending PIM RP Advertisements to the BSR, page 343](#)
- [Configuring BSR for Use Within Scoped Zones, page 344](#)
- [Configuring BSR Routers to Announce Scope-to-RP Mappings, page 345](#)

Configuring a BSR and Verifying BSR Information

This task describes how to configure a BSR on a specified interface and verify BSR configuration information.

SUMMARY STEPS

1. **enable**
2. **configure terminal**
3. **ipv6 pim bsr candidate bsr *ipv6-address* [*hash-mask-length*] [**priority** *priority-value*] [**scope** *scope-value*]**
4. **interface *type number***
5. **ipv6 pim bsr border**
6. **exit**
7. **show ipv6 pim bsr {**election** | **rp-cache** | **candidate-rp**}**

DETAILED STEPS

	Command or Action	Purpose
Step 1	enable Example: Router> enable	Enables privileged EXEC mode. <ul style="list-style-type: none"> • Enter your password if prompted.
Step 2	configure terminal Example: Router# configure terminal	Enters global configuration mode.
Step 3	ipv6 pim bsr candidate bsr <i>ipv6-address</i> [<i>hash-mask-length</i>] [priority <i>priority-value</i>] [scope <i>scope-value</i>] Example: Router(config)# ipv6 pim bsr candidate bsr 2001:0DB8:3000:3000::42 124 priority 10	Configures a router to be a candidate BSR.

	Command or Action	Purpose
Step 4	<code>interface type number</code> Example: Router(config)# interface FastEthernet 1/0	Specifies an interface type and number, and places the router in interface configuration mode.
Step 5	<code>ipv6 pim bsr border</code> Example: Router(config-if)# ipv6 pim bsr border	Configures a border for all BSMs of any scope on a specified interface.
Step 6	<code>exit</code> Example: Router(config-if)# exit	Enter this command twice to exit interface configuration mode and enter privileged EXEC mode.
Step 7	<code>show ipv6 pim bsr {election rp-cache candidate-rp}</code> Example: Router# show ipv6 pim bsr election	Displays information related to PIM BSR protocol processing.

Sending PIM RP Advertisements to the BSR

This task explains how to configure a router to send PIM RP advertisements to the BSR.

SUMMARY STEPS

1. `enable`
2. `configure terminal`
3. `ipv6 pim bsr candidate rp ipv6-address [group-list access-list-name] [priority priority-value] [interval seconds] [scope scope-value] [bidir]`
4. `interface type number`
5. `ipv6 pim bsr border`

DETAILED STEPS

	Command or Action	Purpose
Step 1	<code>enable</code> Example: Router> enable	Enables privileged EXEC mode. <ul style="list-style-type: none"> • Enter your password if prompted.
Step 2	<code>configure terminal</code> Example: Router# configure terminal	Enters global configuration mode.

	Command or Action	Purpose
Step 3	<pre>ipv6 pim bsr candidate rp ipv6-address [group-list access-list-name] [priority priority-value] [interval seconds] [scope scope-value] [bidir]</pre> <p>Example: Router(config)# ipv6 pim bsr candidate rp 2001:0DB8:3000:3000::42 priority 0 </p>	Sends PIM RP advertisements to the BSR.
Step 4	<pre>interface type number</pre> <p>Example: Router(config)# interface FastEthernet 1/0 </p>	Specifies an interface type and number, and places the router in interface configuration mode.
Step 5	<pre>ipv6 pim bsr border</pre> <p>Example: Router(config-if)# ipv6 pim bsr border </p>	Configures a border for all BSMs of any scope on a specified interface.

Configuring BSR for Use Within Scoped Zones

The following task enables you to use BSR within scoped zones. A user can configure candidate BSRs and a set of candidate RPs for each administratively scoped region in the domain.

If scope is specified on the candidate RP, then this router will advertise itself as C-RP only to the BSR for the specified scope. If the group list is specified along with the scope, then only prefixes in the access list with the same scope as that configured will be advertised.

If a scope is specified on the bootstrap router, the BSR will originate BSMs including the group range associated with the scope and accept C-RP announcements for groups that belong to the given scope.

SUMMARY STEPS

1. **enable**
2. **configure terminal**
3. **ipv6 pim bsr candidate bsr ipv6-address [hash-mask-length] [priority priority-value] [scope scope-value]**
4. **ipv6 pim bsr candidate rp ipv6-address [group-list access-list-name] [priority priority-value] [interval seconds] [scope scope-value] [bidir]**
5. **interface type number**
6. **ipv6 multicast boundary scope scope-value**

DETAILED STEPS

	Command or Action	Purpose
Step 1	enable Example: Router> enable	Enables privileged EXEC mode. <ul style="list-style-type: none">• Enter your password if prompted.
Step 2	configure terminal Example: Router# configure terminal	Enters global configuration mode.
Step 3	ipv6 pim bsr candidate bsr <i>ipv6-address</i> [<i>hash-mask-length</i>] [priority <i>priority-value</i>] [scope <i>scope-value</i>] Example: Router(config)# ipv6 pim bsr candidate bsr 2001:0DB8:1:1:4 scope 6	Configures a router to be a candidate BSR.
Step 4	ipv6 pim bsr candidate rp <i>ipv6-address</i> [group-list <i>access-list-name</i>] [priority <i>priority-value</i>] [interval <i>seconds</i>] [scope <i>scope-value</i>] [bidir] Example: Router(config)# ipv6 pim bsr candidate rp 2001:0DB8:1:1:1 group-list list scope 6	Configures the candidate RP to send PIM RP advertisements to the BSR.
Step 5	interface <i>type number</i> Example: Router(config)# interface FastEthernet 1/0	Specifies an interface type and number, and places the router in interface configuration mode.
Step 6	ipv6 multicast boundary scope <i>scope-value</i> Example: Router(config-if)# ipv6 multicast boundary scope 6	Configures a multicast boundary on the interface for a specified scope.

Configuring BSR Routers to Announce Scope-to-RP Mappings

IPv6 BSR routers can be statically configured to announce scope-to-RP mappings directly instead of learning them from candidate-RP messages. A user might want to configure a BSR router to announce scope-to-RP mappings so that an RP that does not support BSR is imported into the BSR. Enabling this feature also allows an RP positioned outside the enterprise's BSR domain to be learned by the known remote RP on the local candidate BSR routers.

SUMMARY STEPS

1. **enable**
2. **configure terminal**

3. **ipv6 pim bsr announced rp** *ipv6-address* [**group-list** *access-list-name*] [**priority** *priority-value*] [**bidir**] [**scope** *scope-value*]

DETAILED STEPS

	Command or Action	Purpose
Step 1	enable Example: Router> enable	Enables privileged EXEC mode. <ul style="list-style-type: none"> • Enter your password if prompted.
Step 2	configure terminal Example: Router# configure terminal	Enters global configuration mode.
Step 3	ipv6 pim bsr announced rp <i>ipv6-address</i> [group-list <i>access-list-name</i>] [priority <i>priority-value</i>] [bidir] [scope <i>scope-value</i>] Example: Router(config)# ipv6 pim bsr announced rp 2001:0DB8:3000:3000::42 priority 0	Announces scope-to-RP mappings directly from the BSR for the specified candidate RP.

Configuring SSM Mapping

When the SSM mapping feature is enabled, DNS-based SSM mapping is automatically enabled, which means that the router will look up the source of a multicast MLD version 1 report from a DNS server.

You can use either DNS-based or static SSM mapping, depending on your router configuration. If you choose to use static SSM mapping, you can configure multiple static SSM mappings. If multiple static SSM mappings are configured, the source addresses of all matching access lists will be used.

This task explains how to enable SSM mapping, disable DNS-based mapping, and configure static SSM mapping.

Restrictions

To use DNS-based SSM mapping, the router needs to find at least one correctly configured DNS server, to which the router may be directly attached.

SUMMARY STEPS

1. **enable**
2. **configure terminal**
3. **ipv6 mld** [**vrf** *vrf-name*] **ssm-map enable**
4. **no ipv6 mld** [**vrf** *vrf-name*] **ssm-map query dns**
5. **ipv6 mld ssm-map** [**vrf** *vrf-name*] **static** *access-list source-address*
6. **exit**

7. `show ipv6 mld ssm-map [source-address]`

DETAILED STEPS

	Command or Action	Purpose
Step 1	<code>enable</code> Example: Router> enable	Enables privileged EXEC mode. <ul style="list-style-type: none">Enter your password if prompted.
Step 2	<code>configure terminal</code> Example: Router# configure terminal	Enters global configuration mode.
Step 3	<code>ipv6 mld [vrf vrf-name] ssm-map enable</code> Example: Router(config)# ipv6 mld ssm-map enable	Enables the SSM mapping feature for groups in the configured SSM range.
Step 4	<code>no ipv6 mld [vrf vrf-name] ssm-map query dns</code> Example: Router(config)# no ipv6 mld ssm-map query dns	Disables DNS-based SSM mapping.
Step 5	<code>ipv6 mld ssm-map [vrf vrf-name] static access-list source-address</code> Example: Router(config)# ipv6 mld ssm-map static SSM_MAP_ACL_2 2001:0DB8:1::1	Configures static SSM mappings.
Step 6	<code>exit</code> Example: Router(config-if)# exit	Exits global configuration mode, and returns the router to privileged EXEC mode.
Step 7	<code>show ipv6 mld ssm-map [source-address]</code> Example: Router# show ipv6 mld ssm-map	Displays SSM mapping information.

Configuring Static Mroutes

This task explains how to configure a static multicast route and verify static mroute information. Static multicast routes (mroutes) in IPv6 can be implemented as an extension of IPv6 static routes. You can configure your router to use a static route for unicast routing only, to use a static multicast route for multicast RPF selection only, or to use a static route for both unicast routing and multicast RPF selection.

SUMMARY STEPS

1. `enable`

2. **configure terminal**
3. **ipv6 route** *ipv6-prefix/prefix-length* {*ipv6-address* | *interface-type interface-number* [*ipv6-address*]} [*administrative-distance*] [*administrative-multicast-distance* | **unicast** | **multicast**] [**tag tag**]
4. **exit**
5. **show ipv6 mroute** [**link-local** | [*group-name* | *group-address* [*source-address* | *source-name*]]] [**summary**] [**count**]
6. **show ipv6 mroute** [**link-local** | *group-name* | *group-address*] **active** [*kbits*]
7. **show ipv6 rpf** *ipv6-prefix*

DETAILED STEPS

	Command or Action	Purpose
Step 1	enable Example: Router> enable	Enables privileged EXEC mode. <ul style="list-style-type: none">• Enter your password if prompted.
Step 2	configure terminal Example: Router# configure terminal	Enters global configuration mode.
Step 3	ipv6 route <i>ipv6-prefix/prefix-length</i> { <i>ipv6-address</i> <i>interface-type interface-number</i> [<i>ipv6-address</i>]} [<i>administrative-distance</i>] [<i>administrative-multicast-distance</i> unicast multicast] [tag tag] Example: Router(config)# ipv6 route 2001:0DB8::/64 6::6 100	Establishes static IPv6 routes. The example shows a static route used for both unicast routing and multicast RPF selection.
Step 4	exit Example: Router(config-if)# exit	Exits global configuration mode, and returns the router to privileged EXEC mode.
Step 5	show ipv6 mroute [link-local [<i>group-name</i> <i>group-address</i> [<i>source-address</i> <i>source-name</i>]]] [summary] [count] Example: Router# show ipv6 mroute ff07::1	Displays the contents of the IPv6 multicast routing table.

	Command or Action	Purpose
Step 6	<pre>show ipv6 mroute [link-local group-name group-address] active [kbps]</pre> <p>Example: Router# show ipv6 mroute active</p>	Displays the active multicast streams on the router.
Step 7	<pre>show ipv6 rpf ipv6-prefix</pre> <p>Example: Router# show ipv6 rpf 2001:0DB8::1:1:2</p>	Checks RPF information for a given unicast host address and prefix.

Configuring IPv6 Multiprotocol BGP

The following tasks explain how to configure IPv6 multiprotocol BGP to perform multicast routing. Note that these multicast BGP tasks related to IPv6 multicast are similar to those multicast BGP tasks for IPv6 unicast.

- [Configuring an IPv6 Peer Group to Perform Multicast BGP Routing, page 349](#)
- [Advertising Routes into IPv6 Multiprotocol BGP, page 351](#)
- [Redistributing Prefixes into IPv6 Multiprotocol BGP, page 352](#)
- [Assigning a BGP Administrative Distance, page 354](#)
- [Generating Translate Updates for IPv6 Multicast BGP, page 355](#)
- [Resetting BGP Sessions, page 356](#)
- [Clearing External BGP Peers, page 356](#)
- [Clearing IPv6 BGP Route Dampening Information, page 357](#)
- [Clearing IPv6 BGP Flap Statistics, page 358](#)

Configuring an IPv6 Peer Group to Perform Multicast BGP Routing

The following tasks explain how to configure an IPv6 peer group to perform multicast BGP routing.

SUMMARY STEPS

1. **enable**
2. **configure terminal**
3. **router bgp** *as-number*
4. **neighbor** *peer-group-name* **peer-group**
5. **neighbor** {*ip-address* | *ipv6-address* | *peer-group-name*} **remote-as** *as-number*
6. **address-family ipv6** [**unicast** | **multicast**]
7. **neighbor** {*ip-address* | *peer-group-name* | *ipv6-address*} **activate**
8. **neighbor** {*ip-address* | *ipv6-address*} **peer-group** *peer-group-name*

DETAILED STEPS

	Command or Action	Purpose
Step 1	<p>enable</p> <p>Example: Router> enable</p>	<p>Enables privileged EXEC mode.</p> <ul style="list-style-type: none"> Enter your password if prompted.
Step 2	<p>configure terminal</p> <p>Example: Router# configure terminal</p>	<p>Enters global configuration mode.</p>
Step 3	<p>router bgp <i>as-number</i></p> <p>Example: Router(config)# router bgp 65000</p>	<p>Enters router configuration mode for the specified BGP routing process.</p>
Step 4	<p>neighbor <i>peer-group-name</i> peer-group</p> <p>Example: Router(config-router)# neighbor group1 peer-group</p>	<p>Creates an multicast BGP peer group.</p>
Step 5	<p>neighbor {<i>ip-address</i> <i>ipv6-address</i> <i>peer-group-name</i>} remote-as <i>as-number</i></p> <p>Example: Router(config-router)# neighbor 2001:0DB8:0:CC00::1 remote-as 64600</p>	<p>Adds the IPv6 address of the neighbor in the specified autonomous system to the IPv6 multicast BGP neighbor table of the local router.</p> <ul style="list-style-type: none"> The <i>ipv6-address</i> argument in the neighbor remote-as command must be in the form documented in RFC 2373 where the address is specified in hexadecimal using 16-bit values between colons.
Step 6	<p>address-family ipv6 [unicast multicast]</p> <p>Example: Router(config-router)# address-family ipv6 multicast</p>	<p>Specifies the IPv6 address family, and enters address family configuration mode.</p> <ul style="list-style-type: none"> The unicast keyword specifies the IPv6 unicast address family. By default, the router is placed in configuration mode for the IPv6 unicast address family if the unicast keyword is not specified with the address-family ipv6 command. The multicast keyword specifies IPv6 multicast address prefixes.

	Command or Action	Purpose
Step 7	<p>neighbor {<i>ip-address</i> <i>peer-group-name</i> <i>ipv6-address</i>} activate</p> <p>Example: Router(config-router-af)# neighbor 2001:0DB8:0:CC00::1 activate</p>	<p>Enables the neighbor to exchange prefixes for the specified family type with the neighbor and the local router.</p> <ul style="list-style-type: none"> To avoid extra configuration steps for each neighbor, use the neighbor activate command with the <i>peer-group-name</i> argument as an alternative in this step.
Step 8	<p>neighbor {<i>ip-address</i> <i>ipv6-address</i>} peer-group <i>peer-group-name</i></p> <p>Example: Router(config-router-af)# neighbor 2001:0DB8:0:CC00::1 peer-group group1</p>	<p>Assigns the IPv6 address of a BGP neighbor to a peer group.</p>

What to Do Next

Refer to the section “Configuring an IPv6 Multiprotocol BGP Peer Group” in the *Implementing Multiprotocol BGP for IPv6* implementation guide and the “Configure BGP Peer Groups” section of the “Configuring BGP” chapter in the *Cisco IOS IP Configuration Guide*, Release 12.4, for more information on assigning options to peer groups and making a BGP or multicast BGP neighbor a member of a peer group.

Advertising Routes into IPv6 Multiprotocol BGP

This task explains how to advertise (inject) a prefix into IPv6 multicast BGP. Note that this task and other multicast BGP tasks related to IPv6 multicast are similar to those multicast BGP tasks for IPv6 unicast.

SUMMARY STEPS

1. **enable**
2. **configure terminal**
3. **router bgp** *as-number*
4. **address-family ipv6** [**unicast** | **multicast**]
5. **network** *ipv6-address/prefix-length*

DETAILED STEPS

	Command or Action	Purpose
Step 1	<p>enable</p> <p>Example: Router> enable</p>	<p>Enables privileged EXEC mode.</p> <ul style="list-style-type: none"> Enter your password if prompted.
Step 2	<p>configure terminal</p> <p>Example: Router# configure terminal</p>	<p>Enters global configuration mode.</p>

	Command or Action	Purpose
Step 3	<pre>router bgp as-number</pre> <p>Example: Router(config)# router bgp 65000</p>	Enters router configuration mode for the specified BGP routing process.
Step 4	<pre>address-family ipv6 [unicast multicast]</pre> <p>Example: Router(config-router)# address-family ipv6 multicast</p>	<p>Specifies the IPv6 address family, and enters address family configuration mode.</p> <ul style="list-style-type: none"> The unicast keyword specifies the IPv6 unicast address family. By default, the router is placed in configuration mode for the IPv6 unicast address family if the unicast keyword is not specified with the address-family ipv6 command. The multicast keyword specifies IPv6 multicast address prefixes.
Step 5	<pre>network ipv6-address/prefix-length</pre> <p>Example: Router(config-router-af)# network 2001:0DB8::/24</p>	<p>Advertises (injects) the specified prefix into the IPv6 BGP database. (The routes must first be found in the IPv6 unicast routing table.)</p> <ul style="list-style-type: none"> Specifically, the prefix is injected into the database for the address family specified in the previous step. Routes are tagged from the specified prefix as “local origin.” The <i>ipv6-prefix</i> argument in the network command must be in the form documented in RFC 2373 where the address is specified in hexadecimal using 16-bit values between colons. The <i>prefix-length</i> argument is a decimal value that indicates how many of the high-order contiguous bits of the address comprise the prefix (the network portion of the address). A slash mark must precede the decimal value.

What to Do Next

Refer to the section “Advertising Routes into IPv6 Multiprotocol BGP” in the *Implementing Multiprotocol BGP for IPv6* implementation guide for more information on assigning options to peer groups and making a BGP or multicast BGP neighbor a member of a peer group.

Redistributing Prefixes into IPv6 Multiprotocol BGP

This task explains how to redistribute (inject) prefixes from another routing protocol into IPv6 multicast BGP. Note that this task and other multicast BGP tasks related to IPv6 multicast are similar to those multicast BGP tasks for IPv6 unicast.

SUMMARY STEPS

1. **enable**
2. **configure terminal**

3. **router bgp** *as-number*
4. **address-family ipv6** [**unicast** | **multicast**]
5. **redistribute protocol** [*process-id*] [**level-1** | **level-1-2** | **level-2**] [**metric** *metric-value*] [**metric-type** {**internal** | **external**}] [**route-map** *map-name*]

DETAILED STEPS

	Command or Action	Purpose
Step 1	enable Example: Router> enable	Enables privileged EXEC mode. <ul style="list-style-type: none"> Enter your password if prompted.
Step 2	configure terminal Example: Router# configure terminal	Enters global configuration mode.
Step 3	router bgp <i>as-number</i> Example: Router(config)# router bgp 65000	Enters router configuration mode for the specified BGP routing process.
Step 4	address-family ipv6 { unicast multicast } Example: Router(config-router)# address-family ipv6 multicast	Specifies the IPv6 address family, and enters address family configuration mode. <ul style="list-style-type: none"> The unicast keyword specifies the IPv6 unicast address family. By default, the router is placed in configuration mode for the IPv6 unicast address family if the unicast keyword is not specified with the address-family ipv6 command. The multicast keyword specifies IPv6 multicast address prefixes.
Step 5	redistribute protocol [<i>process-id</i>] [level-1 level-1-2 level-2] [metric <i>metric-value</i>] [metric-type { internal external }] [route-map <i>map-name</i>] Example: Router(config-router-af)# redistribute rip	Specifies the routing protocol from which prefixes should be redistributed into IPv6 multicast BGP. <ul style="list-style-type: none"> The <i>protocol</i> argument can be one of the following keywords: bgp, connected, isis, rip, or static. <p>Note The connected keyword refers to routes that are established automatically by IPv6 having been enabled on an interface.</p>

What to Do Next

Refer to the section “Redistributing Prefixes into IPv6 Multiprotocol BGP” in the *Implementing Multiprotocol BGP for IPv6* implementation guide for more information on assigning options to peer groups and making a BGP or multicast BGP neighbor a member of a peer group.

Configuring Aggregate Addresses

To configure aggregate addresses for Multicast BGP, refer to the “Configuring Aggregate Addresses” section of the “Configuring BGP” chapter in the *Cisco IOS IP Configuration Guide*, Release 12.4.

Assigning a BGP Administrative Distance

This task explains how to specify an administrative distance for multicast BGP routes to be used in RPF lookups for comparison with unicast routes. Please note that this task and other multicast BGP tasks related to IPv6 multicast are similar to those multicast BGP tasks for IPv6 unicast.



Caution

Changing the administrative distance of BGP internal routes is considered dangerous and is not recommended. One problem that can arise is the accumulation of routing table inconsistencies, which can break routing.

SUMMARY STEPS

1. **enable**
2. **configure terminal**
3. **router bgp** *as-number*
4. **address-family ipv6** [**unicast** | **multicast**]
5. **distance bgp** *external-distance internal-distance local-distance*

DETAILED STEPS

	Command or Action	Purpose
Step 1	enable Example: Router> enable	Enables privileged EXEC mode. <ul style="list-style-type: none">• Enter your password if prompted.
Step 2	configure terminal Example: Router# configure terminal	Enters global configuration mode.
Step 3	router bgp <i>as-number</i> Example: Router(config)# router bgp 100	Enters router configuration mode for the specified routing process.

	Command or Action	Purpose
Step 4	<code>address-family ipv6 [unicast multicast]</code> Example: Router(config-router)# address-family ipv6 multicast	Enters address family configuration mode for configuring routing sessions such as BGP that use standard IPv6 address prefixes.
Step 5	<code>distance bgp external-distance internal-distance local-distance</code> Example: Router(config-router)# distance bgp 20 20 200	Assigns a BGP administrative distance.

Generating Translate Updates for IPv6 Multicast BGP

This task explains how to generate IPv6 multicast BGP updates that correspond to unicast IPv6 updates received from a peer.

The multicast BGP translate-update feature generally is used in a multicast BGP-capable router that peers with a customer site that has only a BGP-capable router; the customer site has not or cannot upgrade its router to an multicast BGP-capable image. Because the customer site cannot originate multicast BGP advertisements, the router with which it peers will translate the BGP prefixes into multicast BGP prefixes, which are used for multicast-source RPF lookup.

SUMMARY STEPS

1. **enable**
2. **configure terminal**
3. **router bgp *as-number***
4. **address-family ipv6 [unicast | multicast]**
5. **neighbor *ipv6-address* translate-update ipv6 multicast [unicast]**

DETAILED STEPS

	Command or Action	Purpose
Step 1	<code>enable</code> Example: Router> enable	Enables privileged EXEC mode. <ul style="list-style-type: none"> • Enter your password if prompted.
Step 2	<code>configure terminal</code> Example: Router# configure terminal	Enters global configuration mode.
Step 3	<code>router bgp <i>as-number</i></code> Example: Router(config)# router bgp 100	Enters router configuration mode for the specified routing process.

	Command or Action	Purpose
Step 4	<pre>address-family ipv6 [unicast multicast]</pre> <p>Example: Router(config-router)# address-family ipv6 multicast</p>	Enters address family configuration mode for configuring routing sessions such as BGP that use standard IPv6 address prefixes.
Step 5	<pre>neighbor ipv6-address translate-update ipv6 multicast [unicast]</pre> <p>Example: Router(config-router)# neighbor 2001:0DB8:7000::2 translate-update ipv6 multicast</p>	Generates multiprotocol IPv6 BGP updates that correspond to unicast IPv6 updates received from a peer.

Resetting BGP Sessions

This task explains how to reset IPv6 BGP sessions.

SUMMARY STEPS

1. **enable**
2. **clear bgp ipv6 {unicast | multicast} {* | autonomous-system-number | ip-address | ipv6-address | peer-group-name} [soft] [in | out]**

DETAILED STEPS

	Command or Action	Purpose
Step 1	<pre>enable</pre> <p>Example: Router> enable</p>	Enables privileged EXEC mode. <ul style="list-style-type: none"> • Enter your password if prompted.
Step 2	<pre>clear bgp ipv6 {unicast multicast} {* autonomous-system-number ip-address ipv6-address peer-group-name} [soft] [in out]</pre> <p>Example: Router# clear bgp ipv6 unicast peer-group marketing soft out</p>	Resets IPv6 BGP sessions.

Clearing External BGP Peers

This task explains how to clear external BGP peers and members of an IPv6 BGP peer group.

SUMMARY STEPS

1. **enable**
2. **clear bgp ipv6 {unicast | multicast} external [soft] [in | out]**

3. `clear bgp ipv6 {unicast | multicast} peer-group [name]`

DETAILED STEPS

	Command or Action	Purpose
Step 1	<code>enable</code> Example: Router> enable	Enables privileged EXEC mode. <ul style="list-style-type: none"> Enter your password if prompted.
Step 2	<code>clear bgp ipv6 {unicast multicast} external [soft] [in out]</code> Example: Router# clear bgp ipv6 unicast external soft in	Clears external IPv6 BGP peers.
Step 3	<code>clear bgp ipv6 {unicast multicast} peer-group [name]</code> Example: Router# clear bgp ipv6 unicast peer-group	Clears all members of an IPv6 BGP peer group.

Clearing IPv6 BGP Route Dampening Information

This task explains how to clear IPv6 BGP route dampening information and how to unsuppress suppressed routes.

SUMMARY STEPS

- `enable`
- `clear bgp ipv6 {unicast | multicast} dampening [ipv6-prefix/prefix-length]`

DETAILED STEPS

	Command or Action	Purpose
Step 1	<code>enable</code> Example: Router> enable	Enables privileged EXEC mode. <ul style="list-style-type: none"> Enter your password if prompted.
Step 2	<code>clear bgp ipv6 {unicast multicast} dampening [ipv6-prefix/prefix-length]</code> Example: Router# clear bgp ipv6 unicast dampening 2001:0DB8:7000::/64	Clears IPv6 BGP route dampening information and unsuppress the suppressed routes.

Clearing IPv6 BGP Flap Statistics

This task explains how to clear IPv6 BGP flap statistics.

SUMMARY STEPS

1. **enable**
2. **clear bgp ipv6 {unicast | multicast} flap-statistics [ipv6-prefix/prefix-length | regexp regexp | filter-list list]**

DETAILED STEPS

	Command or Action	Purpose
Step 1	enable Example: Router> enable	Enables privileged EXEC mode. <ul style="list-style-type: none"> • Enter your password if prompted.
Step 2	clear bgp ipv6 {unicast multicast} flap-statistics [ipv6-prefix/prefix-length regexp regexp filter-list list] Example: Router# clear bgp ipv6 multicast flap-statistics	Clears IPv6 BGP flap statistics.

Using MFIB in IPv6 Multicast

Multicast forwarding is automatically enabled when IPv6 multicast routing is enabled. The following tasks explain how to display information to verify MFIB configuration and operation and reset MFIB as needed.

- [Verifying MFIB Operation in IPv6 Multicast, page 358](#)
- [Resetting MFIB Traffic Counters, page 359](#)

Verifying MFIB Operation in IPv6 Multicast

This task explains how to display and verify MFIB use in IPv6 multicast.

SUMMARY STEPS

1. **enable**
2. **show ipv6 mfib [link-local | ipv6-prefix/prefix-length | group-name | group-address [source-name | source-address]] [verbose]**
3. **show ipv6 mfib [link-local | group-name | group-address] active [kpbs]**
4. **show ipv6 mfib [link-local | group-name | group-address [source-name | source-address]] count**
5. **show ipv6 mfib interface**
6. **show ipv6 mfib status**

7. show ipv6 mfib summary

DETAILED STEPS

	Command or Action	Purpose
Step 1	enable Example: Router> enable	Enables privileged EXEC mode. <ul style="list-style-type: none"> Enter your password if prompted.
Step 2	show ipv6 mfib [link-local <i>ipv6-prefix/prefix-length</i> <i>group-name</i> <i>group-address</i> [<i>source-name</i> <i>source-address</i>]] [verbose] Example: Router# show ipv6 mfib	Displays the forwarding entries and interfaces in the IPv6 MFIB.
Step 3	show ipv6 mfib [link-local <i>group-name</i> <i>group-address</i>] active [<i>kbps</i>] Example: Router# show ipv6 mfib active	Displays the rate at which active sources are sending to multicast groups.
Step 4	show ipv6 mfib [link-local <i>group-name</i> <i>group-address</i> [<i>source-name</i> <i>source-address</i>]] count Example: Router# show ipv6 mfib count	Displays summary traffic statistics from the MFIB about the group and source.
Step 5	show ipv6 mfib interface Example: Router# show ipv6 mfib interface	Displays information about IPv6 multicast-enabled interfaces and their forwarding status.
Step 6	show ipv6 mfib status Example: Router# show ipv6 mfib status	Displays general MFIB configuration and operational status.
Step 7	show ipv6 mfib summary Example: Router# show ipv6 mfib summary	Displays summary information about the number of IPv6 MFIB entries and interfaces.

Resetting MFIB Traffic Counters

This task explains how to reset all active MFIB traffic counters.

SUMMARY STEPS

1. **enable**
2. **clear ipv6 mfib counters** [*group-name* | *group-address* [*source-address* | *source-name*]]

DETAILED STEPS

	Command or Action	Purpose
Step 1	enable Example: Router> enable	Enables privileged EXEC mode. <ul style="list-style-type: none"> • Enter your password if prompted.
Step 2	clear ipv6 mfib counters [<i>group-name</i> <i>group-address</i> [<i>source-address</i> <i>source-name</i>]] Example: Router# clear ipv6 mfib counters FF04::10	Resets all active MFIB traffic counters.

Disabling Default Features in IPv6 Multicast

Several features are automatically enabled when IPv6 multicast is used. However, a user may want to disable certain features in response to certain situations. The following tasks describe these situations and how to disable specific IPv6 multicast features.

- [Disabling Embedded RP Support in IPv6 PIM, page 360](#)
- [Turning Off IPv6 PIM on a Specified Interface, page 361](#)
- [Disabling MLD Router-Side Processing, page 362](#)
- [Disabling MFIB on the Router, page 363](#)
- [Disabling MFIB on a Distributed Platform, page 363](#)
- [Disabling MFIB Interrupt-Level IPv6 Multicast Forwarding, page 364](#)

Disabling Embedded RP Support in IPv6 PIM

A user might want to disable embedded RP support on an interface if all of the routers in the domain do not support embedded RP. This task explains how to disable embedded RP support in IPv6 PIM.



Note

This task disables PIM completely, not just embedded RP support in IPv6 PIM.

SUMMARY STEPS

1. **enable**
2. **configure terminal**
3. **no ipv6 pim rp embedded**
4. **interface** *type number*

5. no ipv6 pim

DETAILED STEPS

	Command or Action	Purpose
Step 1	enable Example: Router> enable	Enables privileged EXEC mode. <ul style="list-style-type: none"> Enter your password if prompted.
Step 2	configure terminal Example: Router# configure terminal	Enters global configuration mode.
Step 3	no ipv6 pim rp embedded Example: Router(config)# no ipv6 pim rp embedded	Disables embedded RP support in IPv6 PIM.
Step 4	interface <i>type number</i> Example: Router(config)# interface FastEthernet 1/0	Specifies an interface type and number, and places the router in interface configuration mode.
Step 5	no ipv6 pim Example: Router(config-if)# no ipv6 pim	Turns off IPv6 PIM on a specified interface.

Turning Off IPv6 PIM on a Specified Interface

A user might only want specified interfaces to perform IPv6 multicast and will therefore want to turn off PIM on a specified interface. This task explains how to turn off PIM on a specified interface.

SUMMARY STEPS

1. **enable**
2. **configure terminal**
3. **interface** *type number*
4. **no ipv6 pim**

DETAILED STEPS

	Command or Action	Purpose
Step 1	enable Example: Router> enable	Enables privileged EXEC mode. <ul style="list-style-type: none"> Enter your password if prompted.
Step 2	configure terminal Example: Router# configure terminal	Enters global configuration mode.
Step 3	interface <i>type number</i> Example: Router(config)# interface FastEthernet 1/0	Specifies an interface type and number, and places the router in interface configuration mode.
Step 4	no ipv6 pim Example: Router(config-if)# no ipv6 pim	Turns off IPv6 PIM on a specified interface.

Disabling MLD Router-Side Processing

A user might only want specified interfaces to perform IPv6 multicast and will therefore want to turn off MLD router-side processing on a specified interface. Use the following task to disable MLD router-side processing on a specified interface.

SUMMARY STEPS

1. **enable**
2. **configure terminal**
3. **interface** *type number*
4. **no ipv6 mld router**

DETAILED STEPS

	Command or Action	Purpose
Step 1	enable Example: Router> enable	Enables privileged EXEC mode. <ul style="list-style-type: none"> Enter your password if prompted.
Step 2	configure terminal Example: Router# configure terminal	Enters global configuration mode.

	Command or Action	Purpose
Step 3	<code>interface type number</code> Example: Router(config)# interface FastEthernet 1/0	Specifies an interface type and number, and places the router in interface configuration mode.
Step 4	<code>no ipv6 mld router</code> Example: Router(config-if)# no ipv6 mld router	Disables MLD router-side processing on a specified interface.

Disabling MFIB on the Router

Multicast forwarding is automatically enabled when IPv6 multicast routing is enabled. However, a user may want to disable multicast forwarding on the router. The following task explains how to disable multicast forwarding on the router:

SUMMARY STEPS

1. `enable`
2. `configure terminal`
3. `no ipv6 mfib`

DETAILED STEPS

	Command or Action	Purpose
Step 1	<code>enable</code> Example: Router> enable	Enables privileged EXEC mode. <ul style="list-style-type: none"> • Enter your password if prompted.
Step 2	<code>configure terminal</code> Example: Router# configure terminal	Enters global configuration mode.
Step 3	<code>no ipv6 mfib</code> Example: Router(config)# no ipv6 mfib	Disables IPv6 multicast forwarding on the router.

Disabling MFIB on a Distributed Platform

Multicast forwarding is automatically enabled when IPv6 multicast routing is enabled. However, a user may want to disable multicast forwarding on a distributed platform. The following task explains how to disable multicast forwarding on a distributed platform:

SUMMARY STEPS

1. **enable**
2. **configure terminal**
3. **ipv6 mfib-mode centralized-only**

DETAILED STEPS

	Command or Action	Purpose
Step 1	enable Example: Router> enable	Enables privileged EXEC mode. •Enter your password if prompted.
Step 2	configure terminal Example: Router# configure terminal	Enters global configuration mode.
Step 3	ipv6 mfib-mode centralized-only Example: Router(config)# ipv6 mfib-mode centralized-only	Disables distributed forwarding on a distributed platform.

Disabling MFIB Interrupt-Level IPv6 Multicast Forwarding

Multicast Forwarding Information Base (MFIB) interrupt-level IPv6 multicast forwarding of outgoing packets on a specific interface is enabled on interfaces that support Cisco Express Forwarding (CEF). However, a user may want to disable MFIB interrupt-level forwarding on a specified interface. The following task explains how to disable this feature:

SUMMARY STEPS

1. **enable**
2. **configure terminal**
3. **interface *type number***
4. **no ipv6 mfib fast**

DETAILED STEPS

	Command or Action	Purpose
Step 1	enable Example: Router> enable	Enables privileged EXEC mode. <ul style="list-style-type: none"> Enter your password if prompted.
Step 2	configure terminal Example: Router# configure terminal	Enters global configuration mode.
Step 3	interface <i>type number</i> Example: Router(config)# interface FastEthernet 1/0	Specifies an interface type and number, and places the router in interface configuration mode.
Step 4	no ipv6 mfib fast Example: Router(config-if)# no ipv6 mfib fast	Disables MFIB interrupt-level IPv6 multicast forwarding of outgoing packets on a specific interface.

Troubleshooting IPv6 Multicast

Use **debug** commands to help you troubleshoot an IPv6 multicast environment. This task describes the commands to display debugging information on IPv6 multicast.

SUMMARY STEPS

- enable**
- debug ipv6 mfib** [*group-name* | *group-address*] [**adjacency** | **signal** | **db** | **init** | **mrrib** | **pak** | **ps**]
- debug ipv6 mld** [*group-name* | *group-address* | *interface-type*]
- debug ipv6 mld explicit** [*group-name* | *group-address*]
- debug ipv6 pim** [*group-name* | *group-address* | *interface-type* | **neighbor** | **bsr**]
- debug bgp ipv6** {**unicast** | **multicast**} **dampening** [**prefix-list** *prefix-list-name*]
- debug bgp ipv6** {**unicast** | **multicast**} **updates** [*ipv6-address*] [**prefix-list** *prefix-list-name*] [**in** | **out**]
- debug ipv6 mrrib client**
- debug ipv6 mrrib io**
- debug ipv6 mrrib proxy**
- debug ipv6 mrrib route** [*group-name* | *group-address*]
- debug ipv6 mrrib table**

DETAILED STEPS

	Command or Action	Purpose
Step 1	<p>enable</p> <p>Example: Router> enable</p>	<p>Enables privileged EXEC mode.</p> <ul style="list-style-type: none"> Enter your password if prompted.
Step 2	<p>debug ipv6 mfib [<i>group-name</i> <i>group-address</i>] [<i>adjacency</i> <i>signal</i> <i>db</i> <i>init</i> <i>mrrib</i> <i>pak</i> <i>ps</i>]</p> <p>Example: Router# debug ipv6 mfib pak FF04::10</p>	Enables debugging output on the IPv6 MFIB.
Step 3	<p>debug ipv6 mld [<i>group-name</i> <i>group-address</i> <i>interface-type</i>]</p> <p>Example: Router# debug ipv6 mld</p>	Enables debugging on MLD protocol activity.
Step 4	<p>debug ipv6 mld explicit [<i>group-name</i> <i>group-address</i>]</p> <p>Example: Router# debug ipv6 mld explicit</p>	Displays information related to the explicit tracking of hosts.
Step 5	<p>debug ipv6 pim [<i>group-name</i> <i>group-address</i> <i>interface-type</i> neighbor bsr]</p> <p>Example: Router# debug ipv6 pim</p>	Enables debugging on PIM protocol activity.
Step 6	<p>debug bgp ipv6 {unicast multicast} dampening [prefix-list <i>prefix-list-name</i>]</p> <p>Example: Router# debug bgp ipv6 multicast</p>	Displays debugging messages for IPv6 BGP dampening.
Step 7	<p>debug bgp ipv6 {unicast multicast} updates [<i>ipv6-address</i>] [prefix-list <i>prefix-list-name</i>] [in out]</p> <p>Example: Router# debug bgp ipv6 multicast updates</p>	Displays debugging messages for IPv6 BGP update packets.
Step 8	<p>debug ipv6 mrrib client</p> <p>Example: Router# debug ipv6 mrrib client</p>	Enables debugging on MRIB client management activity.
Step 9	<p>debug ipv6 mrrib io</p> <p>Example: Router# debug ipv6 mrrib io</p>	Enables debugging on MRIB I/O events.

	Command or Action	Purpose
Step 10	<code>debug ipv6 mrib proxy</code> Example: Router# <code>debug ipv6 mrib proxy</code>	Enables debugging on MRIB proxy activity between the route processor and line cards on distributed router platforms.
Step 11	<code>debug ipv6 mrib route</code> [<i>group-name</i> <i>group-address</i>] Example: Router# <code>debug ipv6 mrib route</code>	Displays information about MRIB routing entry-related activity.
Step 12	<code>debug ipv6 mrib table</code> Example: Router# <code>debug ipv6 mrib table</code>	Enables debugging on MRIB table management activity.

Examples

This section provides the following output examples:

- [Sample Output for the show ipv6 mrib Command, page 368](#)
- [Sample Output for the show ipv6 mrib active Command, page 368](#)
- [Sample Output for the show ipv6 mrib count Command, page 368](#)
- [Sample Output for the show ipv6 mrib interface Command, page 369](#)
- [Sample Output for the show ipv6 mrib summary Command, page 369](#)
- [Sample Output for the show ipv6 mld groups Command, page 369](#)
- [Sample Output for the show ipv6 mld groups summary Command, page 370](#)
- [Sample Output for the show ipv6 mld interface Command, page 370](#)
- [Sample Output for the show ipv6 mld traffic Command, page 370](#)
- [Sample Output for the show ipv6 mld traffic Command, page 370](#)
- [Sample Output for the show ipv6 mrib client Command, page 371](#)
- [Sample Output for the show ipv6 mrib route Command, page 371](#)
- [Sample Output for the show ipv6 mroute Command, page 371](#)
- [Sample Output for the show ipv6 mroute active Command, page 371](#)
- [Sample Output for the show ipv6 pim bsr Command, page 372](#)
- [Sample Output for the show ipv6 pim group-map Command, page 372](#)
- [Sample Output for the show ipv6 pim interface Command, page 372](#)
- [Sample Output for the show ipv6 pim join-prune statistic Command, page 372](#)
- [Sample Output for the show ipv6 pim neighbor Command, page 373](#)
- [Sample Output for the show ipv6 pim range-list Command, page 373](#)
- [Sample Output for the show ipv6 pim topology Command, page 373](#)
- [Sample Output for the show ipv6 pim traffic Command, page 374](#)
- [Sample Output for the show ipv6 pim tunnel Command, page 374](#)

- [Sample Output for the show ipv6 rpf Command, page 375](#)

Sample Output for the show ipv6 mfib Command

The following example displays the forwarding entries and interfaces in the MFIB. The router is configured for fast switching, and it has a receiver joined to FF05::1 on Ethernet1/1 and a source (2001:0DB8:1:1:200) sending on Ethernet1/2:

```
Router# show ipv6 mfib

IP Multicast Forwarding Information Base
Entry Flags: C - Directly Connected, S - Signal, IA - Inherit A flag,
             AR - Activity Required, D - Drop
Forwarding Counts: Pkt Count/Pkts per second/Avg Pkt Size/Kbits per second
Other counts: Total/RPF failed/Other drops
Interface Flags: A - Accept, F - Forward, NS - Negate Signalling
                 IC - Internal Copy, NP - Not platform switched
                 SP - Signal Present
Interface Counts: FS Pkt Count/PS Pkt Count
(*,FF00::/8) Flags: C
  Forwarding: 0/0/0/0, Other: 0/0/0
  Tunnel0 Flags: NS
(*,FF00::/15) Flags: D
  Forwarding: 0/0/0/0, Other: 0/0/0
(*,FF05::1) Flags: C
  Forwarding: 2/0/100/0, Other: 0/0/0
  Tunnel0 Flags: A NS
  Ethernet1/1 Flags: F NS
    Pkts: 0/2
(2001:0DB8:1:1:200,FF05::1) Flags:
  Forwarding: 5/0/100/0, Other: 0/0/0
  Ethernet1/2 Flags: A
  Ethernet1/1 Flags: F NS
    Pkts: 3/2
(*,FF10::/15) Flags: D
  Forwarding: 0/0/0/0, Other: 0/0/0
```

Sample Output for the show ipv6 mfib active Command

The following example displays statistics on the rate at which active IP multicast sources are sending information. The router is switching traffic from 2001:0DB8:1:1:200 to FF05::1:

```
Router# show ipv6 mfib active

Active IPv6 Multicast Sources - sending >= 4 kbps
Group: FF05::1
  Source: 2001:0DB8:1:1:200
    Rate: 20 pps/16 kbps(1sec), 0 kbps(last 128 sec)
```

Sample Output for the show ipv6 mfib count Command

The following example displays statistics from the MFIB about the group and source. The router is switching traffic from 2001:0DB8:1:1:200 to FF05::1:

```
Router# show ipv6 mfib count

IP Multicast Statistics
54 routes, 7 groups, 0.14 average sources per group
Forwarding Counts: Pkt Count/Pkts per second/Avg Pkt Size/Kilobits per second
Other counts: Total/RPF failed/Other drops(OIF-null, rate-limit etc)
Group: FF00::/8
  RP-tree:   Forwarding: 0/0/0/0, Other: 0/0/0
Group: FF00::/15
  RP-tree:   Forwarding: 0/0/0/0, Other: 0/0/0
```

```

Group: FF05::1
  RP-tree:   Forwarding: 2/0/100/0, Other: 0/0/0
  Source: 10::1:1:200,   Forwarding: 367/10/100/7, Other: 0/0/0
  Tot. shown: Source count: 1, pkt count: 369
Group: FF10::/15
  RP-tree:   Forwarding: 0/0/0/0, Other: 0/0/0
Group: FF20::/15
  RP-tree:   Forwarding: 0/0/0/0, Other: 0/0/0

```

Sample Output for the show ipv6 mfib interface Command

The following example displays information about IPv6 multicast-enabled interfaces and their forwarding status. The router is configured for fast switching:

```
Router# show ipv6 mfib interface
```

```

IPv6 Multicast Forwarding (MFIB) status:
  Configuration Status: enabled
  Operational Status: running

```

MFIB interface	status	CEF-based output
		[configured,available]
Ethernet1/1	up	[yes ,yes]
Ethernet1/2	up	[yes ,?]
Tunnel0	up	[yes ,?]
Tunnel1	up	[yes ,?]

Sample Output for the show ipv6 mfib summary Command

The following example displays summary information about the number of IPv6 MFIB entries and interfaces:

```
Router# show ipv6 mfib summary
```

```

IPv6 MFIB summary:
  54      total entries [1 (S,G), 7 (*,G), 46 (*,G/m)]
  17      total MFIB interfaces

```

Sample Output for the show ipv6 mld groups Command

The following is sample output from the **show ipv6 mld groups** command. It shows all of the groups joined by Fast Ethernet interface 2/1, including link-local groups used by network protocols.

```
Router# show ipv6 mld groups FastEthernet 2/1
```

MLD Connected Group Membership			
Group Address	Interface	Uptime	Expires
FF02::2	FastEthernet2/1	3d18h	never
FF02::D	FastEthernet2/1	3d18h	never
FF02::16	FastEthernet2/1	3d18h	never
FF02::1:FF00:1	FastEthernet2/1	3d18h	00:00:27
FF02::1:FF00:79	FastEthernet2/1	3d18h	never
FF02::1:FF23:83C2	FastEthernet2/1	3d18h	00:00:22
FF02::1:FFAF:2C39	FastEthernet2/1	3d18h	never
FF06:7777::1	FastEthernet2/1	3d18h	00:00:26

Sample Output for the show ipv6 mld groups summary Command

The following is sample output from the **show ipv6 mld groups summary** command:

```
Router# show ipv6 mld groups summary
```

```
MLD Route Summary
  No. of (*,G) routes = 5
  No. of (S,G) routes = 0
```

Sample Output for the show ipv6 mld interface Command

The following is sample output from the **show ipv6 mld interface** command for Fast Ethernet interface 2/1:

```
Router# show ipv6 mld interface FastEthernet 2/1
```

```
FastEthernet2/1 is up, line protocol is up
Internet address is FE80::205:5FFF:FEAF:2C39/10
MLD is enabled in interface
Current MLD version is 2
MLD query interval is 125 seconds
MLD querier timeout is 255 seconds
MLD max query response time is 10 seconds
Last member query response interval is 1 seconds
MLD activity: 25 joins, 17 leaves
MLD querying router is FE80::205:5FFF:FEAF:2C39 (this system)
```

Sample Output for the show ipv6 mld ssm-map Command

The following examples show SSM mapping for the source address 2001:0DB8::1:

```
Router# show ipv6 mld ssm-map 2001:0DB8::1
```

```
Group address   : 2001:0DB8::1
Group mode ssm  : TRUE
Database        : STATIC
Source list     : 2001:0DB8::2
                  2001:0DB8::3
```

```
Router# show ipv6 mld ssm-map 2001:0DB8::2
```

```
Group address   : 2001:0DB8::2
Group mode ssm  : TRUE
Database        : DNS
Source list     : 2001:0DB8::3
                  2001:0DB8::1
```

Sample Output for the show ipv6 mld traffic Command

The following example displays the MLD protocol messages received and sent.

```
Router# show ipv6 mld traffic
```

```
MLD Traffic Counters
Elapsed time since counters cleared:00:00:21

Valid MLD Packets      Received      Sent
Queries                1             0
Reports                2             1
Leaves                 0             0
Mtrace packets         0             0

Errors:
Malformed Packets     0
```

```

Bad Checksums                                0
Martian source                               0
Packets Received on MLD-disabled Interface  0

```

Sample Output for the show ipv6 mrib client Command

The following is sample output from the **show ipv6 mrib client** command:

```

Router# show ipv6 mrib client

IP MRIB client-connections
igmp:145          (connection id 0)
pim:146 (connection id 1)
mfib ipv6:3      (connection id 2)
slot 3  mfib ipv6 rp agent:16  (connection id 3)
slot 1  mfib ipv6 rp agent:16  (connection id 4)
slot 0  mfib ipv6 rp agent:16  (connection id 5)
slot 4  mfib ipv6 rp agent:16  (connection id 6)
slot 2  mfib ipv6 rp agent:16  (connection id 7)

```

Sample Output for the show ipv6 mrib route Command

The following is sample output from the **show ipv6 mrib route** command using the **summary** keyword:

```

Router# show ipv6 mrib route summary

MRIB Route-DB Summary
  No. of (*,G) routes = 52
  No. of (S,G) routes = 0
  No. of Route x Interfaces (RxI) = 10

```

Sample Output for the show ipv6 mroute Command

Using the **show ipv6 mroute** command is a good way to dynamically verify that multicast IPv6 data is flowing. The following is sample output from the **show ipv6 mroute** command:

```

Router# show ipv6 mroute ff07::1

Multicast Routing Table
Flags:D - Dense, S - Sparse, B - Bidir Group, s - SSM Group,
      C - Connected, L - Local, I - Received Source Specific Host Report,
      P - Pruned, R - RP-bit set, F - Register flag, T - SPT-bit set,
      J - Join SPT
Timers:Uptime/Expires
Interface state:Interface, State

(*, FF07::1), 00:04:45/00:02:47, RP 2001:0DB8:6::6, flags:S
  Incoming interface:Tunnel5
  RPF nbr:6:6:6:6
  Outgoing interface list:
    POS4/0, Forward, 00:04:45/00:02:47

(2001:0DB8:999::99, FF07::1), 00:02:06/00:01:23, flags:SFT
  Incoming interface:POS1/0
  RPF nbr:2001:0DB8:999::99
  Outgoing interface list:
    POS4/0, Forward, 00:02:06/00:03:27

```

Sample Output for the show ipv6 mroute active Command

The following is sample output from the **show ipv6 mroute active** command:

```

Router# show ipv6 mroute active

Active IPv6 Multicast Sources - sending >= 4 kbps
Group:FF05::1

```

```
Source:2001:0DB8:1:1:1
Rate:11 pps/8 kbps(1sec), 8 kbps(last 8 sec)
```

Sample Output for the show ipv6 pim bsr Command

The following example displays BSM election information:

```
Router# show ipv6 pim bsr election

PIMv2 BSR information
BSR Election Information
Scope Range List: ff00::/8
This system is the Bootstrap Router (BSR)
BSR Address: 2001:0DB8:1:1:4
Uptime: 00:11:55, BSR Priority: 0, Hash mask length: 126
RPF: FE80::A8BB:CCFF:FE03:C400,Ethernet0/0
BS Timer: 00:00:07
This system is candidate BSR
Candidate BSR address: 2001:0DB8:1:1:4, priority: 0, hash mask length: 126
```

Sample Output for the show ipv6 pim group-map Command

The following is sample output from the show ipv6 pim group-map command:

```
Router# show ipv6 pim group-map

FF33::/32*
  SSM
  Info source:Static
  Uptime:00:08:32, Groups:0
FF34::/32*
  SSM
  Info source:Static
  Uptime:00:09:42, Groups:0
```

Sample Output for the show ipv6 pim interface Command

The following is sample output from the show ipv6 pim interface command using the state-on keyword:

```
Router# show ipv6 pim interface state-on

Interface          PIM Nbr   Hello DR
                   Count Intvl Prior

Ethernet0          on   0     30    1
  Address:FE80::208:20FF:FE08:D7FF
  DR      :this system
POS1/0              on   0     30    1
  Address:FE80::208:20FF:FE08:D554
  DR      :this system
POS4/0              on   1     30    1
  Address:FE80::208:20FF:FE08:D554
  DR      :FE80::250:E2FF:FE8B:4C80
POS4/1              on   0     30    1
  Address:FE80::208:20FF:FE08:D554
  DR      :this system
Loopback0           on   0     30    1
  Address:FE80::208:20FF:FE08:D554
  DR      :this system
```

Sample Output for the show ipv6 pim join-prune statistic Command

The following example provides the join/prune aggregation on Ethernet interface 0/0/0:

```
Router# show ipv6 pim join-prune statistic Ethernet0/0/0
```

```

PIM Average Join/Prune Aggregation for last (1K/10K/50K) packets
Interface                Transmitted                Received
Ethernet0/0/0           0 / 0 / 0                 1 / 0 / 0

```

Sample Output for the show ipv6 pim neighbor Command

The following is sample output from the **show ipv6 pim neighbor** command using the **detail** keyword to identify the additional addresses of the neighbors learned through the routable address hello option:

```

Router# show ipv6 pim neighbor detail

Neighbor Address(es)      Interface      Uptime      Expires DR pri Bidir
FE80::A8BB:CCFF:FE00:401  Ethernet0/0   01:34:16   00:01:16 1      B
60::1:1:3
FE80::A8BB:CCFF:FE00:501  Ethernet0/0   01:34:15   00:01:18 1      B
60::1:1:4

```

Sample Output for the show ipv6 pim range-list Command

The following is sample output from the **show ipv6 pim range-list** command:

```

Router# show ipv6 pim range-list

config SSM Exp:never Learnt from ::
FF33::/32 Up:00:26:33
FF34::/32 Up:00:26:33
FF35::/32 Up:00:26:33
FF36::/32 Up:00:26:33
FF37::/32 Up:00:26:33
FF38::/32 Up:00:26:33
FF39::/32 Up:00:26:33
FF3A::/32 Up:00:26:33
FF3B::/32 Up:00:26:33
FF3C::/32 Up:00:26:33
FF3D::/32 Up:00:26:33
FF3E::/32 Up:00:26:33
FF3F::/32 Up:00:26:33
config SM RP:40::1:1:1 Exp:never Learnt from ::
FF13::/64 Up:00:03:50
config SM RP:40::1:1:3 Exp:never Learnt from ::
FF09::/64 Up:00:03:50

```

Sample Output for the show ipv6 pim topology Command

The following is sample output from the **show ipv6 pim topology** command:

```

Router# show ipv6 pim topology

IP PIM Multicast Topology Table
Entry state:(*/S,G)[RPT/SPT] Protocol Uptime Info
Entry flags:KAT - Keep Alive Timer, AA - Assume Alive, PA - Probe Alive,
  RA - Really Alive, LH - Last Hop, DSS - Don't Signal Sources,
  RR - Register Received, SR - Sending Registers, E - MSDP External,
  DCC - Don't Check Connected
Interface state:Name, Uptime, Fwd, Info
Interface flags:LI - Local Interest, LD - Local Dissinterest,
  II - Internal Interest, ID - Internal Dissinterest,
  LH - Last Hop, AS - Assert, AB - Admin Boundary

(*,FF05::1)
SM UP:02:26:56 JP:Join(now) Flags:LH

```

```

RP:2001:0DB8:1:1:2
RPF:Ethernet1/1,FE81::1
  Ethernet0/1          02:26:56  fwd LI LH

(2001:0DB8:1:1:200,FF05::1)
SM UP:00:00:07 JP:Null(never) Flags:
RPF:Ethernet1/1,FE80::30:1:4
  Ethernet1/1          00:00:07  off LI

```

Sample Output for the show ipv6 pim traffic Command

The following example shows the number of PIM protocol messages received and sent.

```
Router# show ipv6 pim traffic
```

```

PIM Traffic Counters
Elapsed time since counters cleared:00:05:29

                Received      Sent
Valid PIM Packets          22         22
Hello                      22         22
Join-Prune                  0          0
Register                   0          0
Register Stop              0          0
Assert                     0          0
Bidir DF Election          0          0

Errors:
Malformed Packets                0
Bad Checksums                    0
Send Errors                       0
Packet Sent on Loopback Errors    0
Packets Received on PIM-disabled Interface 0
Packets Received with Unknown PIM Version 0

```

Sample Output for the show ipv6 pim tunnel Command

The following is sample output from the `show ipv6 pim tunnel` command on the RP:

```
Router# show ipv6 pim tunnel
```

```

Tunnel0*
Type  :PIM Encap
RP    :100::1
Source:100::1
Tunnel0*
Type  :PIM Decap
RP    :100::1
Source: -

```

The following is sample output from the `show ipv6 pim tunnel` command on a non-RP:

```
Router# show ipv6 pim tunnel
```

```

Tunnel0*
Type  :PIM Encap
RP    :100::1
Source:2001::1:1:1

```

Sample Output for the show ipv6 rpf Command

The following example displays RPF information for the unicast host with the IPv6 address of 2001:0DB8:1:1:2:

```
Router# show ipv6 rpf 2001:0DB8:1:1:2

RPF information for 2001:0DB8:1:1:2
RPF interface:Ethernet3/2
RPF neighbor:FE80::40:1:3
RPF route/mask:20::/64
RPF type:Unicast
RPF recursion count:0
Metric preference:110
Metric:30
```

Configuration Examples for IPv6 Multicast

This section provides the following configuration examples:

- [Enabling IPv6 Multicast Routing: Example, page 375](#)
- [Configuring PIM: Examples, page 376](#)
- [Configuring PIM Options: Example, page 376](#)
- [Configuring the MLD Protocol: Examples, page 376](#)
- [Configuring Explicit Tracking of Receivers: Example, page 376](#)
- [Configuring Mroutes: Example, page 377](#)
- [Configuring an IPv6 Multiprotocol BGP Peer Group: Example, page 377](#)
- [Advertising Routes into IPv6 Multiprotocol BGP: Example, page 377](#)
- [Redistributing Prefixes into IPv6 Multiprotocol BGP: Example, page 377](#)
- [Generating Translate Updates for IPv6 Multicast BGP: Example, page 377](#)
- [Disabling Embedded RP Support in IPv6 PIM: Example, page 378](#)
- [Turning Off IPv6 PIM on a Specified Interface: Example, page 378](#)
- [Disabling MLD Router-Side Processing: Example, page 378](#)
- [Disabling and Reenabling MFIB: Example, page 378](#)

Enabling IPv6 Multicast Routing: Example

The following example enables multicast routing on all interfaces. Entering this command also enables multicast forwarding for PIM and MLD on all enabled interfaces of the router.

```
Router> enable
Router# configure terminal
Router(config)# ipv6 multicast-routing
```

Configuring PIM: Examples

The following example shows how to configure a router to use PIM-SM using 2001:0DB8::1 as the RP. The following example sets the SPT threshold to infinity to prevent switchover to the source tree when a source starts sending traffic and sets a filter on all sources that do not have a local multicast BGP prefix.

```
Router(config)# ipv6 multicast-routing
Router(config)# ipv6 pim rp-address 2001:0DB8::1
Router(config)# ipv6 pim spt-threshold infinity
Router(config)# ipv6 pim accept-register route-map reg-filter
```

Configuring PIM Options: Example

The following example sets the DR priority, sets the PIM hello interval, and sets the periodic join and prune announcement interval on Ethernet interface 0/0.

```
Router(config)# interface Ethernet0/0
Router(config)# ipv6 pim hello-interval 60
Router(config)# ipv6 pim dr-priority 3
Router(config)# ipv6 pim join-prune-interval 75
```

Configuring the MLD Protocol: Examples

The following example shows how to configure the query maximum response time, the query timeout, and the query interval on FastEthernet interface 1/0:

```
Router> enable
Router# configure terminal
Router(config)# interface FastEthernet 1/0
Router(config-if)# ipv6 mld query-max-response-time 20
Router(config-if)# ipv6 mld query-timeout 130
Router(config-if)# ipv6 mld query-interval 60
```

The following example configures MLD reporting for a specified group and source, allows the user to perform IPv6 multicast receiver access control, and statically forwards traffic for the multicast group onto FastEthernet interface 1/0:

```
Router> enable
Router# configure terminal
Router(config)# interface FastEthernet 1/0
Router(config)# ipv6 mld join-group FF04::10
Router(config)# ipv6 mld static-group FF04::10 100::1
Router(config)# ipv6 mld access-group acc-grp-1
```

Configuring Explicit Tracking of Receivers: Example

The following example shows how to configure the explicit tracking of receivers:

```
Router> enable
Router# configure terminal
Router(config)# interface FastEthernet 1/0
Router(config-if)# ipv6 mld explicit-tracking list1
```

Configuring Mroutes: Example

The following example shows how to configure a static multicast route to be used for multicast RPF selection only.

```
Router> enable
Router# configure terminal
Router(config)# ipv6 route 2001:0DB8::/64 7::7 100 multicast
```

Configuring an IPv6 Multiprotocol BGP Peer Group: Example

The following example configures the IPv6 multiprotocol BGP peer group named group1:

```
router bgp 65000
no bgp default ipv4-unicast
neighbor group1 peer-group
neighbor 2001:0DB8:0:CC00::1 remote-as 64600

address-family ipv6 multicast
neighbor 3FFE:C00:0:1:A8BB:CCFF:FE00:8200 activate
no auto-summary
no synchronization
exit-address-family
```

Advertising Routes into IPv6 Multiprotocol BGP: Example

The following example injects the IPv6 network 2001:0DB8::/24 into the IPv6 multicast database of the local router. (BGP checks that a route for the network exists in the IPv6 multicast database of the local router before advertising the network.)

```
router bgp 65000
no bgp default ipv4-unicast

address-family ipv6 multicast
network 2001:0DB8::/24
```

Redistributing Prefixes into IPv6 Multiprotocol BGP: Example

The following example redistributes BGP routes into the IPv6 multicast database of the local router:

```
router bgp 64900
no bgp default ipv4-unicast
address-family ipv6 multicast
redistribute BGP
```

Generating Translate Updates for IPv6 Multicast BGP: Example

The following example shows how to generate IPv6 multicast BGP updates that correspond to unicast IPv6 updates.

```
router bgp 64900
no bgp default ipv4-unicast
address-family ipv6 multicast
neighbor 2001:0DB8:7000::2 translate-update ipv6 multicast
```

Disabling Embedded RP Support in IPv6 PIM: Example

The following example disables embedded RP support on IPv6 PIM:

```
Router(config)# ipv6 multicast-routing
Router(config)# no ipv6 pim rp embedded
```

Turning Off IPv6 PIM on a Specified Interface: Example

The following example turns off IPv6 PIM on FastEthernet interface 1/0:

```
Router(config)# ipv6 multicast-routing
Router(config)# interface FastEthernet 1/0
Router(config)# no ipv6 pim
```

Disabling MLD Router-Side Processing: Example

The following example turns off MLD router-side processing on FastEthernet interface 1/0:

```
Router> enable
Router# configure terminal
Router(config)# interface FastEthernet 1/0
Router(config-if)# no ipv6 mld router
```

Disabling and Reenabling MFIB: Example

Multicast forwarding is automatically enabled when IPv6 multicast routing is enabled; however, a user may want to disable multicast forwarding on the router. The following example shows how to disable multicast forwarding on the router and, if desired, reenables multicast forwarding on the router. The example also shows how to disable MFIB interrupt-level IPv6 multicast forwarding of outgoing packets on FastEthernet interface 1/0:

```
Router> enable
Router# configure terminal
Router(config) no ipv6 mfib
Router(config) ipv6 mfib-mode centralized-only
Router(config) interface FastEthernet 1/0
Router(config-if) no ipv6 mfib fast
```

Additional References

See the following sections for additional information related to IPv6 multicast.

Related Documents

Related Topic	Document Title
IPv6 multicast addresses	<i>Implementing Basic Connectivity for IPv6</i>
IPv6 supported feature list	<i>Start Here: Cisco IOS Software Release Specifics for IPv6 Features</i>
Multicast BGP for IPv6	<i>Implementing Multiprotocol BGP for IPv6</i>

Related Topic	Document Title
IPv6 static routes	<i>Implementing Static Routes for IPv6</i>
IPv6 tunnels	<i>Implementing Tunneling for IPv6</i>
Platform-specific information for Cisco 12000 series Internet Routers	12.0(26)S release notes, <i>New Software Features in Cisco IOS Release 12.0(26)S</i>
IPv6 commands: complete command syntax, command mode, defaults, usage guidelines, and examples	<i>IPv6 for Cisco IOS Command Reference</i>
IPv4 configuration and command reference information	<i>Cisco IOS IP Configuration Guide, Release 12.4</i> <i>Cisco IOS IP Command Reference, Volume 3 of 4: Multicast, Release 12.4</i>

Standards and Drafts

Standards	Title
draft-ietf-pim-sm-v2-new	<i>Protocol Independent Multicast - Sparse Mode PIM-SM): Protocol Specification (Revised)</i> , March 6, 2003
draft-savola-mboned-mcast-rpaddr	<i>Embedding the Address of RP in IPv6 Multicast Address</i> , May 23, 2003
draft-suz-pim-upstream-detection	<i>PIM Upstream Detection Among Multiple Addresses</i> , February 2003
draft-ietf-pim-bidir-05	<i>Bi-directional Protocol Independent Multicast (BIDIR-PIM)</i> , June 20, 2003
draft-ietf-pim-sm-bsr-03.txt	<i>Bootstrap Router (BSR) Mechanism for PIM Sparse Mode</i> , February 25, 2003

MIBs

MIBs	MIBs Link
No new or modified MIBs are supported by this feature, and support for existing MIBs has not been modified by this feature.	To locate and download MIBs for selected platforms, Cisco IOS releases, and feature sets, use Cisco MIB Locator found at the following URL: http://www.cisco.com/go/mibs

RFCs

RFCs	Title
RFC 2373	<i>IP Version 6 Addressing Architecture</i>
RFC 2460	<i>Internet Protocol, Version 6 (IPv6) Specification</i>
RFC 2461	<i>Neighbor Discovery for IP version 6 (IPv6)</i>
RFC 2462	<i>IPv6 Stateless Address Autoconfiguration</i>
RFC 3576	<i>Change of Authorization</i>
RFC 3590	<i>Source Address Selection for the Multicast Listener Discovery (MLD) Protocol</i>
RFC 3810	<i>Multicast Listener Discovery Version 2 (MLDv2) for IPv6</i>
RFC 4007	<i>IPv6 Scoped Address Architecture</i>

Technical Assistance

Description	Link
The Cisco Technical Support website contains thousands of pages of searchable technical content, including links to products, technologies, solutions, technical tips, and tools. Registered Cisco.com users can log in from this page to access even more content.	http://www.cisco.com/techsupport



Implementing NAT Protocol Translation

Network Address Translation - Protocol Translation (NAT-PT) is an IPv6-IPv4 translation mechanism, as defined in RFC 2765 and RFC 2766, allowing IPv6-only devices to communicate with IPv4-only devices and vice versa.

Finding Support Information for Platforms and Cisco IOS Software Images

Use Cisco Feature Navigator to find information about platform support and Cisco IOS software image support. Access Cisco Feature Navigator at <http://www.cisco.com/go/fn>. You must have an account on Cisco.com. If you do not have an account or have forgotten your username or password, click **Cancel** at the login dialog box and follow the instructions that appear.

Contents

- [Prerequisites for Implementing NAT-PT, page 381](#)
- [Restrictions for Implementing NAT-PT, page 382](#)
- [Information About Implementing NAT-PT, page 382](#)
- [How to Implement NAT-PT, page 385](#)
- [Configuration Examples for NAT-PT, page 398](#)
- [Where to Go Next, page 400](#)
- [Additional References, page 401](#)

Prerequisites for Implementing NAT-PT

Before implementing NAT-PT, you must configure IPv4 and IPv6 on the router interfaces that need to communicate between IPv4-only and IPv6-only networks.

[Table 22](#) identifies the earliest release for each early-deployment train in which the feature became available.

Table 22 Minimum Required Cisco IOS Release

Feature	Minimum Required Cisco IOS Release by Release Train
NAT Protocol Translation	12.2(13)T, 12.3, 12.3(2)T, 12.4
File Transfer Protocol (FTP) Application Layer Gateway (ALG)	12.3(2)T, 12.4
Support for fragmentation	12.3(2)T, 12.4
Support for DNS ALG	12.2(13)T, 12.3, 12.3(2)T, 12.4
Support for port address translation (PAT) or overload (NAPT-PT)	12.3(2)T, 12.4
Support for translations in Cisco Express Forwarding (CEF) switching	12.3(14)T, 12.4

Restrictions for Implementing NAT-PT

- NAT-PT currently provides limited Application Layer Gateway (ALG) support. ALG support for Internet Control Message Protocol (ICMP), File Transfer Protocol (FTP), and Domain Naming System (DNS) is provided, and future Cisco IOS releases will have ALG support similar to NAT for other applications.
- NAT-PT has the same restrictions that apply to IPv4 NAT where NAT-PT does not provide end-to-end security and the NAT-PT router can be a single point of failure in the network.
- Users must decide whether to use Static NAT-PT operation, Dynamic NAT-PT operation, Port Address Translation (PAT), or IPv4-mapped operation. Deciding which operation to use determines how a user will configure and operate NAT-PT.

Information About Implementing NAT-PT

This section provides an overview of NAT-PT for Cisco IOS software. Users can configure NAT-PT using one of the following operations—static NAT-PT, dynamic NAT-PT, Port Address Translation (PAT), or IPv4-mapped operation—which are described in the following sections:

- [NAT-PT, page 382](#)
- [Static NAT-PT Operation, page 383](#)
- [Dynamic NAT-PT Operation, page 384](#)
- [Port Address Translation \(PAT\) or Overload, page 385](#)
- [IPv4-Mapped Operation, page 385](#)

NAT-PT

NAT-PT for Cisco IOS software was designed using RFC 2766 and RFC 2765 as a migration tool to help customers transition their IPv4 networks to IPv6 networks. Using a protocol translator between IPv6 and IPv4 allows direct communication between hosts speaking a different network protocol. Users can use either static definitions or IPv4-mapped definitions for NAT-PT operation.

Figure 33 shows NAT-PT runs on a router between an IPv6 network and an IPv4 network to connect an IPv6-only node with an IPv4-only node.

Figure 33 NAT-PT Basic Operation

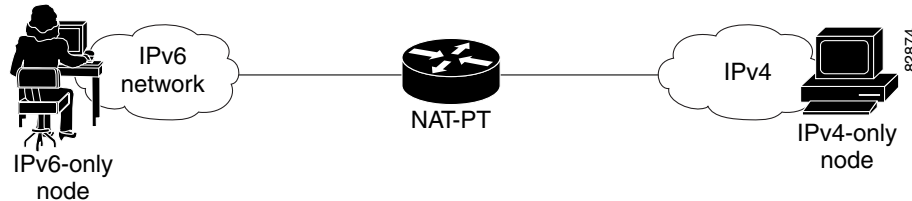

Although IPv6 solves addressing issues for customers, a long transition period is likely before customers move to an exclusive IPv6 network environment. During the transition period any new IPv6-only networks will need to continue to communicate with existing IPv4 networks. NAT-PT is designed to be deployed to allow direct communication between IPv6-only networks and IPv4-only networks. For a service provider customer an example could be an IPv6-only client trying to access an IPv4-only web server. Enterprise customers will also migrate to IPv6 in stages, and many of their IPv4-only networks will be operational for several years. Dual stack networks may have some IPv6-only hosts configured to take advantage of the IPv6 autoconfiguration, global addressing, and simpler management, and these hosts can use NAT-PT to communicate with existing IPv4-only networks in the same organization.

One of the benefits of NAT-PT is that no changes are required to existing hosts because all the NAT-PT configurations are performed at the NAT-PT router. Customers with existing stable IPv4 networks can introduce an IPv6 network and use NAT-PT to allow communication without disrupting the existing network. To further illustrate the seamless transition, File Transfer Protocol (FTP) can be used between IPv4 and IPv6 networks just as within an IPv4 network. Packet fragmentation is enabled by default when IPv6 is configured allowing IPv6 and IPv4 networks to resolve fragmentation problems between the networks. Without the ability to resolve fragmentation, connectivity could become intermittent when fragmented packets might be dropped or improperly interpreted.

Cisco has developed other transition techniques including dual stack, IPv6 over MPLS, and tunneling. NAT-PT should not be used when other native communication techniques exist. If a host is configured as a dual stack host with both IPv4 and IPv6, we do not recommend using NAT-PT to communicate between the dual stack host and an IPv6-only or IPv4-only host. NAT-PT is not recommended for a scenario in which an IPv6-only network is trying to communicate to another IPv6-only network via an IPv4 backbone or vice versa, because NAT-PT would require a double translation to be performed. In this scenario, tunneling techniques would be recommended.

The following sections describe the operations that may be used to configure NAT-PT. Users have the option to use one of the following operations for NAT-PT operation, but not all four.

Static NAT-PT Operation

Static NAT-PT uses static translation rules to map one IPv6 address to one IPv4 address. IPv6 network nodes communicate with IPv4 network nodes using an IPv6 mapping of the IPv4 address configured on the NAT-PT router.

Figure 34 shows how the IPv6-only node named A can communicate with the IPv4-only node named C using NAT-PT. The NAT-PT device is configured to map the source IPv6 address for node A of 2001:0db8:bbbb:1::1 to the IPv4 address 192.168.99.2. NAT-PT is also configured to map the source address of IPv4 node C, 192.168.30.1 to 2001:0db8::a. When packets with a source IPv6 address of node

A are received at the NAT-PT router they are translated to have a destination address to match node C in the IPv4-only network. NAT-PT can also be configured to match a source IPv4 address and translate the packet to an IPv6 destination address to allow an IPv4-only host communicate with an IPv6-only host. If you have multiple IPv6-only or IPv4-only hosts that need to communicate, you may need to configure many static NAT-PT mappings. Static NAT-PT is useful when applications or servers require access to a stable IPv4 address. Accessing an external IPv4 DNS server is an example where static NAT PT can be used.

Figure 34 Static NAT-PT Operation

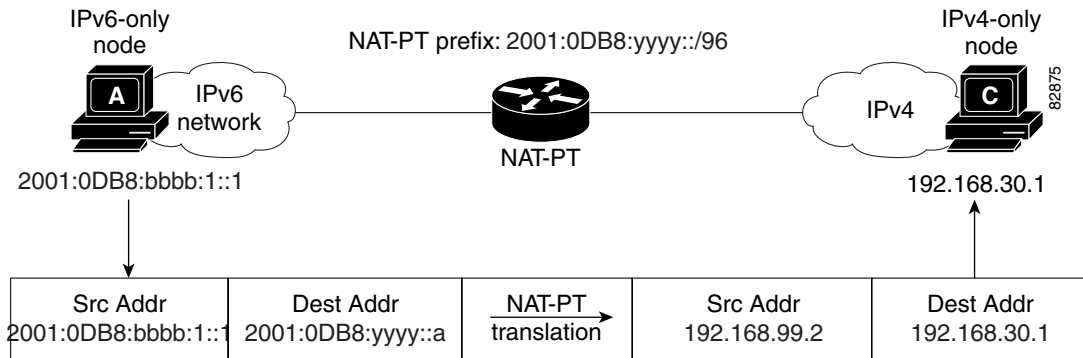

Dynamic NAT-PT Operation

Dynamic NAT-PT allows multiple NAT-PT mappings by allocating addresses from a pool. NAT-PT is configured with a pool of IPv6 and/or IPv4 addresses. At the start of a NAT-PT session a temporary address is dynamically allocated from the pool. The number of addresses available in the address pool determines the maximum number of concurrent sessions. The NAT-PT device records each mapping between addresses in a dynamic state table.

Figure 35 shows how dynamic NAT-PT operates. The IPv6-only node B can communicate with the IPv4-only node D using dynamic NAT-PT. The NAT-PT device is configured with an IPv6 access list, prefix list, or route map to determine which packets are to be translated by NAT-PT. A pool of IPv4 addresses—10.21.8.1 to 10.21.8.10 in Figure 35—is also configured. When an IPv6 packet to be translated is identified, NAT-PT uses the configured mapping rules and assigns a temporary IPv4 address from the configured pool of IPv4 addresses.

Figure 35 Dynamic NAT-PT Operation

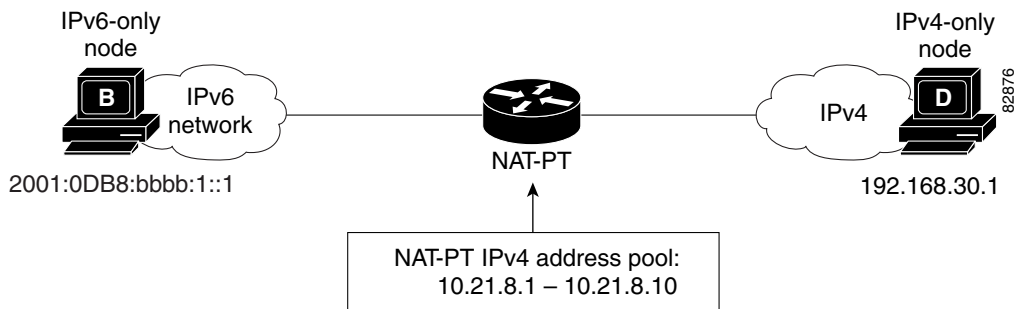

Dynamic NAT-PT translation operation requires at least one static mapping for the IPv4 DNS server.

After the IPv6 to IPv4 connection is established, the reply packets going from IPv4 to IPv6 take advantage of the previously established dynamic mapping to translate back from IPv4 to IPv6. If the connection is initiated by an IPv4-only host then the explanation is reversed.

Port Address Translation (PAT) or Overload

Port Address Translation (PAT), also known as Overload, allows a single IPv4 address to be used among multiple sessions by multiplexing on the port number to associate several IPv6 users with a single IPv4 address. The Port Address Translation can be accomplished through a specific interface or through a pool of addresses. [Figure 36](#) shows multiple IPv6 addresses from the IPv6 network linked to a single IPv4 interface into the IPv4 network.

Figure 36 Port Address Translation

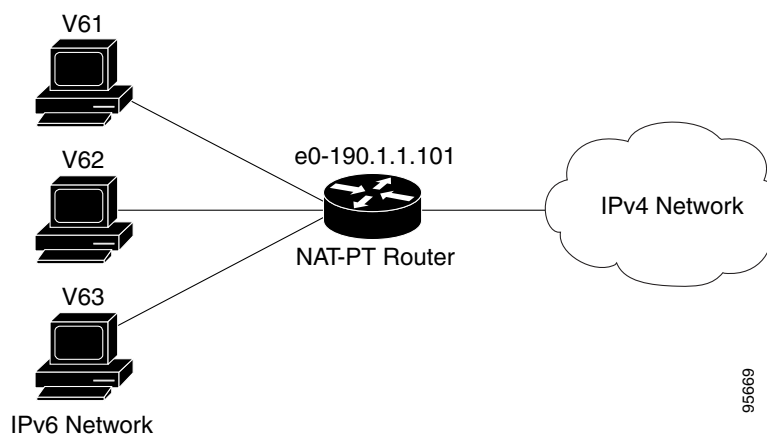

IPv4-Mapped Operation

Customers can also send traffic from their IPv6 network to an IPv4 network without configuring IPv6 destination address mapping. A packet arriving at an interface is checked to discover if it has a NAT-PT prefix that was configured with the `ipv6 nat prefix v4-mapped` command. If the prefix does match, then an access-list check is performed to discover if the source address matches the access list or prefix list. If the prefix does not match, the packet is dropped.

If the prefix matches, source address translation is performed. If a rule has been configured for the source address translation, the last 32 bits of the destination IPv6 address is used as the IPv4 destination and a flow entry is created.

How to Implement NAT-PT

- [Configuring Basic IPv6 to IPv4 Connectivity for NAT-PT, page 386](#) (required)
- [Configuring IPv4-Mapped NAT-PT, page 387](#) (required)
- [Configuring Mappings for IPv6 Hosts Accessing IPv4 Hosts, page 388](#) (required)
- [Configuring Mappings for IPv4 Hosts Accessing IPv6 Hosts, page 391](#) (optional)
- [Configuring Port Address Translation, page 392](#)

- [Verifying NAT-PT Configuration and Operation, page 394](#) (optional)

Configuring Basic IPv6 to IPv4 Connectivity for NAT-PT

This task explains how to configure the NAT-PT prefix globally, and enable NAT-PT on an interface. For NAT-PT to be operational, NAT-PT must be enabled on both the incoming and outgoing interfaces.

NAT-PT Prefix

An IPv6 prefix with a prefix length of 96 must be specified for NAT-PT to use. The IPv6 prefix can be a unique local unicast prefix, a subnet of your allocated IPv6 prefix, or even an extra prefix obtained from your Internet service provider (ISP). The NAT-PT prefix is used to match a destination address of an IPv6 packet. If the match is successful, NAT-PT will use the configured address mapping rules to translate the IPv6 packet to an IPv4 packet. The NAT-PT prefix can be configured globally or with different IPv6 prefixes on individual interfaces. Using a different NAT-PT prefix on several interfaces allows the NAT-PT router to support an IPv6 network with multiple exit points to IPv4 networks.

SUMMARY STEPS

1. **enable**
2. **configure terminal**
3. **ipv6 nat prefix** *ipv6-prefix/prefix-length*
4. **interface** *type number*
5. **ipv6 address** *ipv6-prefix {/prefix-length | link-local}*
6. **ipv6 nat**
7. **exit**
8. **interface** *type number*
9. **ip address** *ip-address mask [secondary]*
10. **ipv6 nat**

DETAILED STEPS

	Command or Action	Purpose
Step 1	enable Example: Router> enable	Enables privileged EXEC mode. <ul style="list-style-type: none"> • Enter your password if prompted.
Step 2	configure terminal Example: Router# configure terminal	Enters global configuration mode.

	Command or Action	Purpose
Step 3	<p>ipv6 nat prefix <i>ipv6-prefix/prefix-length</i></p> <p>Example: Router# ipv6 nat prefix 2001:0db8::/96</p>	<p>Assigns an IPv6 prefix as a global NAT-PT prefix.</p> <ul style="list-style-type: none"> Matching destination prefixes in IPv6 packets are translated by NAT-PT. The only prefix length supported is 96.
Step 4	<p>interface <i>type number</i></p> <p>Example: Router(config)# interface ethernet 3/1</p>	<p>Specifies an interface type and number, and places the router in interface configuration mode.</p>
Step 5	<p>ipv6 address <i>ipv6-address</i> {/prefix-length link-local}</p> <p>Example: Router(config-if)# ipv6 address 2001:0db8:yyyy:1::9/64</p>	<p>Specifies an IPv6 address assigned to the interface and enables IPv6 processing on the interface.</p>
Step 6	<p>ipv6 nat</p> <p>Example: Router(config-if)# ipv6 nat</p>	<p>Enables NAT-PT on the interface.</p>
Step 7	<p>exit</p> <p>Example: Router(config-if)# exit</p>	<p>Exits interface configuration mode, and returns the router to global configuration mode.</p>
Step 8	<p>interface <i>type number</i></p> <p>Example: Router(config)# interface ethernet 3/3</p>	<p>Specifies an interface type and number, and places the router in interface configuration mode.</p>
Step 9	<p>ip address <i>ip-address mask</i> [secondary]</p> <p>Example: Router(config-if)# ip address 192.168.30.9 255.255.255.0</p>	<p>Specifies an IP address and mask assigned to the interface and enables IP processing on the interface.</p>
Step 10	<p>ipv6 nat</p> <p>Example: Router(config-if)# ipv6 nat</p>	<p>Enables NAT-PT on the interface.</p>

Configuring IPv4-Mapped NAT-PT

The following task describes how to enable customers to send traffic from their IPv6 network to an IPv4 network without configuring IPv6 destination address mapping. This task shows the the **ipv6 nat prefix v4-mapped** command configured on a specified interface, but the command could alternatively be configured globally:

SUMMARY STEPS

1. **enable**
2. **configure terminal**
3. **interface** *type number*
4. **ipv6 nat prefix** *ipv6-prefix v4-mapped* {*access-list-name* | *ipv6-prefix*}

DETAILED STEPS

	Command or Action	Purpose
Step 1	enable Example: Router> enable	Enables privileged EXEC mode. <ul style="list-style-type: none"> • Enter your password if prompted.
Step 2	configure terminal Example: Router# configure terminal	Enters global configuration mode.
Step 3	interface <i>type number</i> Example: Router(config)# interface ethernet 3/1	Specifies an interface type and number, and places the router in interface configuration mode.
Step 4	ipv6 nat prefix <i>ipv6-prefix v4-mapped</i> { <i>access-list-name</i> <i>ipv6-prefix</i> } Example: Router(config-if)# ipv6 nat prefix 2001::/96 v4-mapped v4map_acl	Enables customers to send traffic from their IPv6 network to an IPv4 network without configuring IPv6 destination address mapping.

Configuring Mappings for IPv6 Hosts Accessing IPv4 Hosts

This task explains how to configure static or dynamic IPv6 to IPv4 address mappings. The dynamic address mappings include assigning a pool of IPv4 addresses and using an access list, prefix list, or route map to define which packets are to be translated.

SUMMARY STEPS

1. **enable**
2. **configure terminal**
3. **ipv6 nat v6v4 source** *ipv6-address ipv4-address*
or
ipv6 nat v6v4 source {*list access-list-name* | *route-map map-name*} **pool name**
4. **ipv6 nat v6v4 pool** *name start-ipv4 end-ipv4 prefix-length prefix-length*
5. **ipv6 nat translation** [*max-entries number*] {*timeout* | *udp-timeout* | *dns-timeout* | *tcp-timeout* | *finrst-timeout* | *icmp-timeout*} {*seconds* | **never**}

6. **ipv6 access-list** *access-list-name*
7. **permit** {*protocol*} {*source-ipv6-prefix/prefix-length* | **any** | **host** *source-ipv6-address*} [*operator* [*port-number*]] {*destination-ipv6-prefix/prefix-length* | **any** | **host** *destination-ipv6-address*}
8. **exit**
9. **show ipv6 nat translations** [**icmp** | **tcp** | **udp**] [**verbose**]
10. **show ipv6 nat statistics**

DETAILED STEPS

	Command or Action	Purpose
Step 1	<p>enable</p> <p>Example: Router> enable</p>	<p>Enables privileged EXEC mode.</p> <ul style="list-style-type: none"> Enter your password if prompted.
Step 2	<p>configure terminal</p> <p>Example: Router# configure terminal</p>	<p>Enters global configuration mode.</p>
Step 3	<p>ipv6 nat v6v4 source <i>ipv6-address</i> <i>ipv4-address</i> or ipv6 nat v6v4 source {list <i>access-list-name</i> route-map <i>map-name</i>} pool <i>name</i></p> <p>Example: Router(config)# ipv6 nat v6v4 source 2001:0db8:yyyy:1::1 10.21.8.10</p> <p>Example: Router(config)# ipv6 nat v6v4 source list pt-list1 pool v4pool</p>	<p>Enables a static IPv6 to IPv4 address mapping using NAT-PT.</p> <p>or</p> <p>Enables a dynamic IPv6 to IPv4 address mapping using NAT-PT.</p> <ul style="list-style-type: none"> Use the list or route-map keyword to specify a prefix list, access list, or a route map to define which packets are translated. Use the pool keyword to specify the name of a pool of addresses, created by the ipv6 nat v6v4 pool command, to be used in dynamic NAT-PT address mapping.
Step 4	<p>ipv6 nat v6v4 pool <i>name</i> <i>start-ipv4</i> <i>end-ipv4</i> prefix-length <i>prefix-length</i></p> <p>Example: Router(config)# ipv6 nat v6v4 pool v4pool 10.21.8.1 10.21.8.10 prefix-length 24</p>	<p>Specifies a pool of IPv4 addresses to be used by NAT-PT for dynamic address mapping.</p>
Step 5	<p>ipv6 nat translation [max-entries <i>number</i>] {timeout udp-timeout dns-timeout tcp-timeout first-timeout icmp-timeout} {<i>seconds</i> never}</p> <p>Example: Router(config)# ipv6 nat translation udp-timeout 600</p>	<p>(Optional) Specifies the time after which NAT-PT translations time out.</p>

Command or Action	Purpose
<p>Step 6</p> <pre>ipv6 access-list access-list-name</pre> <p>Example: Router(config)# ipv6 access-list pt-list1</p>	<p>(Optional) Defines an IPv6 access list and enters IPv6 access list configuration mode. The router prompt changes to Router(config-ipv6-acl)#.</p> <ul style="list-style-type: none"> The <i>access-list name</i> argument specifies the name of the IPv6 access control list (ACL). IPv6 ACL names cannot contain a space or quotation mark, or begin with a numeral.
<p>Step 7</p> <pre>permit {protocol} {source-ipv6-prefix/prefix-length any host source-ipv6-address} [operator [port-number]] {destination-ipv6-prefix/prefix-length any host destination-ipv6-address}</pre> <p>Example: Router(config-ipv6-acl)# permit ipv6 2001:0db8:bbbb:1::/64 any</p>	<p>(Optional) Specifies permit conditions for an IPv6 ACL.</p> <ul style="list-style-type: none"> The <i>protocol</i> argument specifies the name or number of an Internet protocol. It can be one of the keywords ahp, esp, icmp, ipv6, pcp, sctp, tcp, or udp, or an integer in the range from 0 to 255 representing an IPv6 protocol number. The <i>source-ipv6-prefix/prefix-length</i> and <i>destination-ipv6-prefix/prefix-length</i> arguments specify the source and destination IPv6 network or class of networks about which to set permit conditions. These arguments must be in the form documented in RFC 2373 where the address is specified in hexadecimal using 16-bit values between colons. The any keyword is an abbreviation for the IPv6 prefix <code>::/0</code>. The host source-ipv6-address keyword and argument combination specifies the source IPv6 host address about which to set permit conditions. The <i>source-ipv6-address</i> argument must be in the form documented in RFC 2373 where the address is specified in hexadecimal using 16-bit values between colons. Only the arguments and keywords relevant to this task are specified here. Refer to the permit command in the <i>IPv6 for Cisco IOS Command Reference</i> document for information on supported arguments and keywords.
<p>Step 8</p> <pre>exit</pre> <p>Example: Router(config-if)# exit</p>	<p>Exits access list configuration mode, and returns the router to global configuration mode. Enter the exit command twice to return to privileged EXEC mode.</p>

	Command or Action	Purpose
Step 1	<pre>show ipv6 nat translations [icmp tcp udp] [verbose]</pre> <p>Example: Router> show ipv6 nat translations verbose</p>	(Optional) Displays active NAT-PT translations. <ul style="list-style-type: none"> Use the optional icmp, tcp, and udp keywords to display detailed information about the NAT-PT translation events for the specified protocol. Use the optional verbose keyword to display more detailed information about the active translations.
Step 1	<pre>show ipv6 nat statistics</pre> <p>Example: Router> show ipv6 nat statistics</p>	(Optional) Displays NAT-PT statistics.

What to Do Next

If you do not require any IPv4 to IPv6 mappings, proceed to the [“Verifying NAT-PT Configuration and Operation”](#) task.

Configuring Mappings for IPv4 Hosts Accessing IPv6 Hosts

This optional task explains how to configure static or dynamic IPv4 to IPv6 address mappings. The dynamic address mappings include assigning a pool of IPv6 addresses and using an access list, prefix list, or route map to define which packets are to be translated.

SUMMARY STEPS

1. **enable**
2. **configure terminal**
3. **ipv6 nat v4v6 source** *ipv4-address ipv6-address*
or
ipv6 nat v4v6 source list {*access-list-number* | *name*} **pool** *name*
4. **ipv6 nat v4v6 pool** *name start-ipv6 end-ipv6 prefix-length prefix-length*
5. **access-list** {*access-list-name* | *number*} {**deny** | **permit**} [*source source-wildcard*] [**log**]

DETAILED STEPS

	Command or Action	Purpose
Step 1	<pre>enable</pre> <p>Example: Router> enable</p>	Enables privileged EXEC mode. <ul style="list-style-type: none"> Enter your password if prompted.
Step 2	<pre>configure terminal</pre> <p>Example: Router# configure terminal</p>	Enters global configuration mode.

	Command or Action	Purpose
Step 3	<pre>ipv6 nat v4v6 source ipv6-address ipv4-address or ipv6 nat v4v6 source list {access-list-number name} pool name</pre> <p>Example: Router(config)# ipv6 nat v4v6 source 10.21.8.11 2001:0db8:yyyy::2 or Router(config)# ipv6 nat v4v6 source list 1 pool v6pool</p>	<p>Enables a static IPv4 to IPv6 address mapping using NAT-PT.</p> <p>or</p> <p>Enables a dynamic IPv4 to IPv6 address mapping using NAT-PT.</p> <ul style="list-style-type: none"> • Use the list keyword to specify an access list to define which packets are translated. • Use the pool keyword to specify the name of a pool of addresses, created by the ipv6 nat v4v6 pool command, to be used in dynamic NAT-PT address mapping.
Step 4	<pre>ipv6 nat v4v6 pool name start-ipv6 end-ipv6 prefix-length prefix-length</pre> <p>Example: Router(config)# ipv6 nat v4v6 pool v6pool 2001:0db8:yyyy::1 2001:0db8:yyyy::2 prefix-length 128</p>	<p>Specifies a pool of IPv6 addresses to be used by NAT-PT for dynamic address mapping.</p>
Step 5	<pre>access-list {access-list-name number} {deny permit} [source source-wildcard] [log]</pre> <p>Example: Router(config)# access-list 1 permit 192.168.30.0 0.0.0.255</p>	<p>Specifies an entry in a standard IPv4 access list.</p>

Configuring Port Address Translation

This task explains how to configure PAT for IPv6 to IPv4 address mappings. Multiple IPv6 addresses are mapped to a single IPv4 address or to a pool of IPv4 addresses and using an access list, prefix list, or route map to define which packets are to be translated.

SUMMARY STEPS

1. **enable**
2. **configure terminal**
3. **ipv6 nat v6v4 source {list access-list-name | route-map map-name} pool name overload**
or
ipv6 nat v6v4 source {list access-list-name | route-map map-name} interface interface name overload
4. **ipv6 nat v6v4 pool name start-ipv4 end-ipv4 prefix-length prefix-length**
5. **ipv6 nat translation [max-entries number] {timeout | udp-timeout | dns-timeout | tcp-timeout | finrst-timeout | icmp-timeout} {seconds | never}**
6. **ipv6 access-list access-list-name**
7. **permit {protocol} {source-ipv6-prefix/prefix-length | any | host source-ipv6-address} [operator [port-number]] {destination-ipv6-prefix/prefix-length | any | host destination-ipv6-address}**

DETAILED STEPS

	Command or Action	Purpose
Step 1	<p>enable</p> <p>Example: Router> enable</p>	<p>Enables privileged EXEC mode.</p> <ul style="list-style-type: none"> Enter your password if prompted.
Step 2	<p>configure terminal</p> <p>Example: Router# configure terminal</p>	<p>Enters global configuration mode.</p>
Step 3	<p>ipv6 nat v6v4 source {list <i>access-list-name</i> route-map <i>map-name</i>} pool <i>name</i> overload or ipv6 nat v6v4 source {list <i>access-list-name</i> route-map <i>map-name</i>} interface <i>interface name</i> overload</p> <p>Example: Router(config)# ipv6 nat v6v4 source 2001:0db8:yyyy:1::1 10.21.8.10</p> <p>Example: Router(config)# ipv6 nat v6v4 source list pt-list1 pool v4pool overload</p>	<p>Enables a dynamic IPv6 to IPv4 address overload mapping using a pool address.</p> <p>or</p> <p>Enables a dynamic IPv6 to IPv4 address overload mapping using an interface address.</p> <ul style="list-style-type: none"> Use the list or route-map keyword to specify a prefix list, access list, or a route map to define which packets are translated. Use the pool keyword to specify the name of a pool of addresses, created by the ipv6 nat v6v4 pool command, to be used in dynamic NAT-PT address mapping. Use the interface keyword to specify the interface address to be used for overload.
Step 4	<p>ipv6 nat v6v4 pool <i>name</i> <i>start-ipv4</i> <i>end-ipv4</i> prefix-length <i>prefix-length</i></p> <p>Example: Router(config)# ipv6 nat v6v4 pool v4pool 10.21.8.1 10.21.8.10 prefix-length 24</p>	<p>Specifies a pool of IPv4 addresses to be used by NAT-PT for dynamic address mapping.</p>
Step 5	<p>ipv6 nat translation [max-entries <i>number</i>] {timeout udp-timeout dns-timeout tcp-timeout finrst-timeout icmp-timeout} {<i>seconds</i> never}</p> <p>Example: Router(config)# ipv6 nat translation udp-timeout 600</p>	<p>(Optional) Specifies the time after which NAT-PT translations time out.</p>

Command or Action	Purpose
<p>Step 6</p> <pre>ipv6 access-list access-list-name</pre> <p>Example: Router(config)# ipv6 access-list pt-list1</p>	<p>(Optional) Defines an IPv6 access list and enters IPv6 access list configuration mode. The router prompt changes to Router(config-ipv6-acl)#.</p> <ul style="list-style-type: none"> The <i>access-list name</i> argument specifies the name of the IPv6 access control list (ACL). IPv6 ACL names cannot contain a space or quotation mark, or begin with a numeral.
<p>Step 7</p> <pre>permit {protocol} {source-ipv6-prefix/prefix-length any host source-ipv6-address} [operator [port-number]] {destination-ipv6-prefix/prefix-length any host destination-ipv6-address}</pre> <p>Example: Router(config-ipv6-acl)# permit ipv6 2001:0db8:bbbb:1::/64 any</p>	<p>(Optional) Specifies permit conditions for an IPv6 ACL.</p> <ul style="list-style-type: none"> The <i>protocol</i> argument specifies the name or number of an Internet protocol. It can be one of the keywords ahp, esp, icmp, ipv6, pcp, sctp, tcp, or udp, or an integer in the range from 0 to 255 representing an IPv6 protocol number. The <i>source-ipv6-prefix/prefix-length</i> and <i>destination-ipv6-prefix/prefix-length</i> arguments specify the source and destination IPv6 network or class of networks about which to set permit conditions. These arguments must be in the form documented in RFC 2373 where the address is specified in hexadecimal using 16-bit values between colons. The any keyword is an abbreviation for the IPv6 prefix <code>::/0</code>. The host source-ipv6-address keyword and argument combination specifies the source IPv6 host address about which to set permit conditions. The <i>source-ipv6-address</i> argument must be in the form documented in RFC 2373 where the address is specified in hexadecimal using 16-bit values between colons. Only the arguments and keywords relevant to this task are specified here. Refer to the permit command in the <i>IPv6 for Cisco IOS Command Reference</i> document for information on supported arguments and keywords.

What to Do Next

If you do not require any Ipv6-to-IPv4 or IPv4-to-IPv6 mappings, proceed to the [“Verifying NAT-PT Configuration and Operation”](#) task.

Verifying NAT-PT Configuration and Operation

This task explains how to display information to verify the configuration and operation of NAT-PT.

SUMMARY STEPS

1. `clear ipv6 nat translation *`

2. **enable**
3. **debug ipv6 nat [detailed]**
4. **debug ipv6 nat [port]**

DETAILED STEPS

	Command or Action	Purpose
Step 1	<pre>clear ipv6 nat translation *</pre> <p>Example: Router> clear ipv6 nat translation *</p>	(Optional) Clears dynamic NAT-PT translations from the dynamic translation state table. <ul style="list-style-type: none"> • Use the * keyword to clear all dynamic NAT-PT translations. <p>Note Static translation configuration is not affected by this command.</p>
Step 2	<pre>enable</pre> <p>Example: Router> enable</p>	Enables higher privilege levels, such as privileged EXEC mode. <ul style="list-style-type: none"> • Enter your password if prompted.
Step 3	<pre>debug ipv6 nat [detailed]</pre> <p>Example: Router# debug ipv6 nat detail</p>	(Optional) Displays debugging messages for NAT-PT translation events. <ul style="list-style-type: none"> • Use the detailed keyword to display more detailed information about the NAT-PT translation events.
Step 4	<pre>debug ipv6 nat [port]</pre> <p>Example: Router# debug ipv6 nat port</p>	Displays port allocation events during NAT-PT overload operation.

Output Examples

This section provides the following output examples:

- [Sample Output for the show ipv6 nat translations Command](#)
- [Sample Output for the show ipv6 nat statistics Command](#)
- [Sample Output for the clear ipv6 nat translation Command](#)
- [Sample Output for the debug ipv6 nat Command](#)

Sample Output for the show ipv6 nat translations Command

In the following example, output information about active NAT-PT translations is displayed using the **show ipv6 nat translations** command:

```
Router> show ipv6 nat translations
```

Prot	IPv4 source	IPv6 source
	IPv4 destination	IPv6 destination
---	---	---
	192.168.123.2	2001:0db8::2
---	---	---
	192.168.122.10	2001:0db8::10
tcp	192.168.124.8,11047	2001:0db8:3::8,11047
	192.168.123.2,23	2001:0db8::2,23
udp	192.168.124.8,52922	2001:0db8:3::8,52922
	192.168.123.2,69	2001::2,69
udp	192.168.124.8,52922	2001:0db8:3::8,52922
	192.168.123.2,52922	2001:0db8::2,52922
---	192.168.124.8	2001:0db8:3::8
	192.168.123.2	2001:0db8::2
---	192.168.124.8	2001:0db8:3::8
	---	---
---	192.168.121.4	2001:0db8:5::4
	---	---

In the following example, detailed output information about active NAT-PT translations is displayed using the **show ipv6 nat translations** command with the **verbose** keyword:

```
Router> show ipv6 nat translations verbose

Prot  IPv4 source          IPv6 source
      IPv4 destination  IPv6 destination
---   ---              ---
      192.168.123.2      2001:0db8::2
      create 00:04:24, use 00:03:24,

---   ---              ---
      192.168.122.10    2001:0db8::10
      create 00:04:24, use 00:04:24,

tcp    192.168.124.8,11047   2001:0db8:3::8,11047
      192.168.123.2,23   2001:0db8::2,23
      create 00:03:24, use 00:03:20, left 00:16:39,

udp    192.168.124.8,52922   2001:0db8:3::8,52922
      192.168.123.2,69   2001:0db8::2,69
      create 00:02:51, use 00:02:37, left 00:17:22,

udp    192.168.124.8,52922   2001:0db8:3::8,52922
      192.168.123.2,52922 2001:0db8::2,52922
      create 00:02:48, use 00:02:30, left 00:17:29,

---   192.168.124.8      2001:0db8:3::8
      192.168.123.2      2001:0db8::2
      create 00:03:24, use 00:02:34, left 00:17:25,

---   192.168.124.8      2001:0db8:3::8
      ---                ---
      create 00:04:24, use 00:03:24,

---   192.168.121.4      2001:0db8:5::4
      ---                ---
      create 00:04:25, use 00:04:25,
```

Sample Output for the show ipv6 nat statistics Command

In the following example, output information about NAT-PT statistics is displayed using the **show ipv6 nat statistics** command:

```
Router> show ipv6 nat statistics

Total active translations: 4 (4 static, 0 dynamic; 0 extended)
NAT-PT interfaces:
  Ethernet3/1, Ethernet3/3
Hits: 0 Misses: 0
Expired translations: 0
```

Sample Output for the clear ipv6 nat translation Command

In the following example, all dynamic NAT-PT translations are cleared from the dynamic translation state table using the **clear ipv6 nat translation** command with the ***** keyword. When the output information about active NAT-PT translations is then displayed using the **show ipv6 nat translations** command, only the static translation configurations remain. Compare this **show** command output with the output for the **show ipv6 nat translations** command in Step 1.

```
Router> clear ipv6 nat translation *

Router> show ipv6 nat translations

Prot  IPv4 source          IPv6 source
      IPv4 destination  IPv6 destination
---  ---                ---
      192.168.123.2     2001:0db8::2

---  ---                ---
      192.168.122.10   2001:0db8::10

---  192.168.124.8     2001:0db8:3::8
      ---                ---

---  192.168.121.4     2001:0db8:5::4
      ---                ---
```

Sample Output for the debug ipv6 nat Command

In the following example, debugging messages for NAT-PT translation events are displayed using the **debug ipv6 nat** command:

```
Router# debug ipv6 nat

00:06:06: IPv6 NAT: icmp src (2001:0db8:3002::8) -> (192.168.124.8), dst
(2001:0db8:2001::2) -> (192.168.123.2)
00:06:06: IPv6 NAT: icmp src (192.168.123.2) -> (2001:0db8:2001::2), dst (192.168.124.8)
-> (2001:0db8:3002::8)
00:06:06: IPv6 NAT: icmp src (2001:0db8:3002::8) -> (192.168.124.8), dst
(2001:0db8:2001::2) -> (192.168.123.2)
00:06:06: IPv6 NAT: icmp src (192.168.123.2) -> (2001:0db8:2001::2), dst (192.168.124.8)
-> (2001:0db8:3002::8)
00:06:06: IPv6 NAT: tcp src (2001:0db8:3002::8) -> (192.168.124.8), dst
(2001:0db8:2001::2) -> (192.168.123.2)
00:06:06: IPv6 NAT: tcp src (192.168.123.2) -> (2001:0db8:2001::2), dst (192.168.124.8) ->
(2001:0db8:3002::8)
00:06:06: IPv6 NAT: tcp src (2001:0db8:3002::8) -> (192.168.124.8), dst
(2001:0db8:2001::2) -> (192.168.123.2)
00:06:06: IPv6 NAT: tcp src (2001:0db8:3002::8) -> (192.168.124.8), dst
(2001:0db8:2001::2) -> (192.168.123.2)
00:06:06: IPv6 NAT: tcp src (2001:0db8:3002::8) -> (192.168.124.8), dst
(2001:0db8:2001::2) -> (192.168.123.2)
00:06:06: IPv6 NAT: tcp src (192.168.123.2) -> (2001:0db8:2001::2), dst (192.168.124.8) ->
(2001:0db8:3002::8)
```

Configuration Examples for NAT-PT

This section provides the following configuration examples:

- [Static NAT-PT Configuration: Example, page 399](#)

- [Enabling Traffic to be Sent from an IPv6 Network to an IPv4 Network without Using IPv6 Destination Address Mapping: Example, page 399](#)
- [Dynamic NAT-PT Configuration for IPv6 Hosts Accessing IPv4 Hosts: Example, page 399](#)
- [Dynamic NAT-PT Configuration for IPv4 Hosts Accessing IPv6 Hosts Example, page 400](#)

Static NAT-PT Configuration: Example

The following example configures the NAT-PT prefix globally, enables NAT-PT on two interfaces, and configures two static NAT-PT mappings. Ethernet interface 3/1 is configured as IPv6 only, and Ethernet interface 3/3 is configured as IPv4 only.

```
interface Ethernet3/1
  ipv6 address 2001:0db8:3002::9/64
  ipv6 enable
  ipv6 nat
!
interface Ethernet3/3
  ip address 192.168.30.9 255.255.255.0
  ipv6 nat
!
ipv6 nat v4v6 source 192.168.30.1 2001:0db8:0::2
ipv6 nat v6v4 source 2001:0db8:bbbb:1::1 10.21.8.10
ipv6 nat prefix 2001:0db8:0::/96
```

Enabling Traffic to be Sent from an IPv6 Network to an IPv4 Network without Using IPv6 Destination Address Mapping: Example

In the following example, the access list permits any IPv6 source address with the prefix 2001::/96 to go to the destination with a 2000::/96 prefix. The destination is then translated to the last 32 bit of its IPv6 address; for example: source address = 2001::1, destination address = 2000::192.168.1.1. The destination then becomes 192.168.1.1 in the IPv4 network:

```
ipv6 nat prefix 2000::/96 v4-mapped v4map_acl

ipv6 access-list v4map_acl
  permit ipv6 2001::/96 2000::/96
```

Dynamic NAT-PT Configuration for IPv6 Hosts Accessing IPv4 Hosts: Example

The following example configures the NAT-PT prefix globally, enables NAT-PT on two interfaces, and configures one static NAT-PT mapping (used, for example, to access a DNS server). A dynamic NAT-PT mapping is also configured to map IPv6 addresses to IPv4 addresses using a pool of IPv4 addresses named v4pool. The packets to be translated by NAT-PT are filtered using an IPv6 access list named pt-list1. The User Datagram Protocol (UDP) translation entries are configured to time out after 10 minutes. Ethernet interface 3/1 is configured as IPv6 only, and Ethernet interface 3/3 is configured as IPv4 only.

```
interface Ethernet3/1
  ipv6 address 2001:0db8:bbbb:1::9/64
  ipv6 enable
  ipv6 nat
!
interface Ethernet3/3
```

```

ip address 192.168.30.9 255.255.255.0
ipv6 nat
!
ipv6 nat v4v6 source 192.168.30.1 2001:0db8:0::2
ipv6 nat v6v4 source list pt-list1 pool v4pool
ipv6 nat v6v4 pool v4pool 10.21.8.1 10.21.8.10 prefix-length 24
ipv6 nat translation udp-timeout 600
ipv6 nat prefix 2001:0db8:1::/96
!
ipv6 access-list pt-list1
permit ipv6 2001:0db8:bbbb:1::/64 any

```

Dynamic NAT-PT Configuration for IPv4 Hosts Accessing IPv6 Hosts Example

The following example configures the NAT-PT prefix globally, enables NAT-PT on two interfaces, and configures one static NAT-PT mapping (used, for example, to access a DNS server). A dynamic NAT-PT mapping is also configured to map IPv4 addresses to IPv6 addresses using a pool of IPv6 addresses named v6pool. The packets to be translated by NAT-PT are filtered using an access list named pt-list2. Ethernet interface 3/1 is configured as IPv6 only, and Ethernet interface 3/3 is configured as IPv4 only.

```

interface Ethernet3/1
  ipv6 address 2001:0db8:bbbb:1::9/64
  ipv6 enable
  ipv6 nat
!
interface Ethernet3/3
  ip address 192.168.30.9 255.255.255.0
  ipv6 nat
!
ipv6 nat v4v6 source list pt-list2 pool v6pool
ipv6 nat v4v6 pool v6pool 2001:0db8:0::1 2001:0db8:0::2 prefix-length 128
ipv6 nat v6v4 source 2001:0db8:bbbb:1::1 10.21.8.0
ipv6 nat prefix 2001:0db8:0::/96
!
access-list pt-list2 permit 192.168.30.0 0.0.0.255

```

Where to Go Next

If you want to implement IPv6 routing protocols, refer to the *Implementing RIP for IPv6*, *Implementing IS-IS for IPv6*, or the *Implementing Multiprotocol BGP for IPv6* module.

Additional References

For additional information related to the NAT Protocol Translation feature, see the following sections.

Related Documents

Related Topic	Document Title
IP addressing and IP services configuration tasks	“Configuring IP Addressing” and “Configuring IP Services” chapters in the <i>Cisco IOS IP Configuration Guide</i> , Release 12.4
IP addressing and IP services commands: complete command syntax, command mode, defaults, usage guidelines, and examples	<i>Cisco IOS IP Command Reference, Volume 1 of 3: Addressing and Services</i> , Release 12.4
IPv6 supported feature list	<i>Start Here: Cisco IOS Software Release Specifics for IPv6 Features</i>
IPv6 commands: complete command syntax, command mode, defaults, usage guidelines, and examples	<i>IPv6 for Cisco IOS Command Reference</i>
IPv4 configuration and command reference information	<i>Cisco IOS Release 12.4 Configuration Guides and Command References</i>

Standards

Standards	Title
No new or modified standards are supported by this feature, and support for existing standards has not been modified by this feature.	—

MIBs

MIBs	MIBs Link
No new or modified MIBs are supported by this feature, and support for existing MIBs has not been modified by this feature.	To locate and download MIBs for selected platforms, Cisco IOS releases, and feature sets, use Cisco MIB Locator found at the following URL: http://www.cisco.com/go/mibs

RFCs

RFCs	Title
RFC 2765	<i>Stateless IP/ICMP Translation Algorithm (SIIT)</i>
RFC 2766	<i>Network Address Translation - Protocol Translation (NAT-PT)</i>

Technical Assistance

Description	Link
The Cisco Technical Support website contains thousands of pages of searchable technical content, including links to products, technologies, solutions, technical tips, and tools. Registered Cisco.com users can log in from this page to access even more content.	http://www.cisco.com/techsupport



Implementing NetFlow for IPv6

First Published: June 26, 2006

Last Updated: June 26, 2006

NetFlow for IPv6 provides basic NetFlow functionality for IPv6 without affecting IPv4 NetFlow performance.

Finding Feature Information in This Module

Your Cisco IOS software release may not support all of the features documented in this module. To reach links to specific feature documentation in this module and to see a list of the releases in which each feature is supported, use the [“Feature Information for Implementing NetFlow for IPv6”](#) section on page 415.

Finding Support Information for Platforms and Cisco IOS Software Images

Use Cisco Feature Navigator to find information about platform support and Cisco IOS software image support. Access Cisco Feature Navigator at <http://www.cisco.com/go/fn>. You must have an account on Cisco.com. If you do not have an account or have forgotten your username or password, click **Cancel** at the login dialog box and follow the instructions that appear.

Contents

- [Prerequisites for Implementing NetFlow for IPv6](#), page 403
- [Information About Implementing NetFlow for IPv6](#), page 404
- [How to Implement NetFlow for IPv6](#), page 404
- [Configuration Examples for Implementing NetFlow for IPv6](#), page 412
- [Where to Go Next](#), page 413
- [Additional References](#), page 413
- [Feature Information for Implementing NetFlow for IPv6](#), page 415

Prerequisites for Implementing NetFlow for IPv6

This document assumes that you are familiar with IPv4. Refer to the publications referenced in the [“Additional References”](#) section for IPv4 configuration and command reference information.

Information About Implementing NetFlow for IPv6

To configure NetFlow for IPv6 for Cisco IOS software, you should understand the following concept:

- [NetFlow for IPv6 Environments, page 404](#)

NetFlow for IPv6 Environments

NetFlow for IPv6 is based on NetFlow Version 9 and functions by identifying packet flows for ingress IP and IPv6 packets. NetFlow enables you to collect traffic flow statistics on your routing devices and analyze traffic patterns, which are used to detect DoS attacks. It does not involve any connection-setup protocol between routers or to any other networking device or end station and does not require any change externally—either to the traffic or packets themselves or to any other networking device.

NetFlow is completely transparent to the existing network, including end stations and application software and network devices such as LAN switches. Also, NetFlow is performed independently on each internetworking device; it need not be operational on each router in the network. You can use NetFlow Data Export (NDE) to export data to a remote workstation for data collection and further processing. Network planners can selectively invoke NDE on a router or on a per-subinterface basis to gain traffic performance, control, or accounting benefits in specific network locations. NetFlow collects accounting information for IPv6 encapsulation and tunnels. If NetFlow capture is configured on a logical interface, IPv6 flows will be reported with that interface as the input or output interface, depending on whether the feature has been activated on the ingress or egress port.

How to Implement NetFlow for IPv6

To configure NetFlow, you must define the exporting scheme that will be used to export NetFlow statistics, configure the NetFlow cache, and configure NetFlow on the interfaces from which statistics will be gathered. The tasks required to complete perform these functions are described in the following sections:

- [Exporting NetFlow Statistics, page 404](#)
- [Customizing the NetFlow Cache, page 406](#)
- [Managing NetFlow Statistics, page 407](#)
- [Configuring an Aggregation Cache, page 408](#)
- [Configuring a NetFlow Minimum Prefix Mask for Router-Based Aggregation, page 410](#)

Exporting NetFlow Statistics

This task describes how to define the exporting scheme that will be used to gather NetFlow statistics.

SUMMARY STEPS

1. **enable**
2. **configure terminal**
3. **ipv6 flow-export version 9 [bgp-nexthop] [origin-as [bgp-nexthop] | peer-as [bgp-nexthop]]**
4. **ipv6 flow-export destination *ip-address udp-port***

5. **ipv6 flow-export template** {refresh-rate *packet-refresh-rate* | timeout *timeout-value*}
6. **ipv6 flow-export template options** {export-stats | refresh-rate *packet-refresh-rate* | timeout *timeout-value*}
7. **interface** *type number*
8. **ipv6 flow** {ingress | egress}

DETAILED STEPS

	Command or Action	Purpose
Step 1	enable Example: Router> enable	Enables privileged EXEC mode. <ul style="list-style-type: none"> • Enter your password if prompted.
Step 2	configure terminal Example: Router# configure terminal	Enters global configuration mode.
Step 3	ipv6 flow-export version 9 [bgp-nexthop] [origin-as [bgp-nexthop] peer-as [bgp-nexthop]] Example: Router(config)# ipv6 flow-export version 9	Enables NetFlow for IPv6 routing.
Step 4	ipv6 flow-export destination <i>ip-address</i> <i>udp-port</i> Example: Router(config)# ipv6 flow-export destination 10.0.101.254 9991	Enables the exporting of information in NetFlow cache entries to a specific address or port.
Step 5	ipv6 flow-export template {refresh-rate <i>packet-refresh-rate</i> timeout <i>timeout-value</i> } Example: Router(config)# ipv6 flow-export template timeout 60	Enables the exporting of information in NetFlow cache entries.
Step 6	ipv6 flow-export template options {export-stats refresh-rate <i>packet-refresh-rate</i> timeout <i>timeout-value</i> } Example: Router(config)# ipv6 flow-export template options export-stats	Configures templates for IPv6 cache exports.

	Command or Action	Purpose
Step 7	<code>interface type number</code> Example: Router(config)# interface atm 0	Specifies an interface type and number, and places the router in interface configuration mode.
Step 8	<code>ipv6 flow {ingress egress}</code> Example: Router(config-if)# ipv6 flow ingress	(Optional) Enables IPv6 flow capture for incoming (ingress) or outgoing (egress) packets. Two commands for ingress and egress can be specified on the same interface. If a switched packet belongs to a flow that is captured at both ingress and egress, it will be accounted twice. This command must be entered on each interface where NetFlow capture is needed.

Customizing the NetFlow Cache

Several options are available for configuring and customizing the NetFlow cache:

- Customize the number of entries in the NetFlow cache
- Customize the timeout.
- Customize the Multiprotocol Label Switching (MPLS) parameters.

These options are described in the following optional task:

- [Customizing the NetFlow Cache, page 406](#)

Customizing the NetFlow Cache

Normally the size of the NetFlow cache will meet your needs. However, you can increase or decrease the number of entries maintained in the cache to meet the needs of your NetFlow traffic rates. The default is 64K flow cache entries. Each cache entry requires about 64 bytes of storage. Assuming a cache with the default number of entries, about 4 MB of DRAM would be required. Each time a new flow is taken from the free flow queue, the number of free flows is checked. If only a few free flows remain, NetFlow attempts to age 30 flows using an accelerated timeout. If only 1 free flow remains, NetFlow automatically ages 30 flows regardless of their age. The intent is to ensure that free flow entries are always available.



Caution

Cisco recommends that you not change the number of NetFlow cache entries. Improper use of this feature could cause network problems. To return to the default NetFlow cache entries, use the **no ip flow-cache entries** global configuration command.

The following task describes how to customize the number of entries in the NetFlow cache.

SUMMARY STEPS

1. **enable**
2. **configure terminal**
3. **ipv6 flow-cache entries *number***
4. **ipv6 flow-cache timeout {active *minutes* | inactive *seconds*}**

5. `ipv6 flow-aggregation cache {as | bgp-nexthop | destination-prefix | prefix | protocol-port | source-prefix}`

DETAILED STEPS

	Command or Action	Purpose
Step 1	enable Example: Router> enable	Enables privileged EXEC mode. <ul style="list-style-type: none"> • Enter your password if prompted.
Step 2	configure terminal Example: Router# configure terminal	Enters global configuration mode.
Step 3	ipv6 flow-cache entries <i>number</i> Example: Router(config)# ipv6 flow-cache entries 131072	Changes the number of entries maintained in the NetFlow cache.
Step 4	ipv6 flow-cache timeout {active <i>minutes</i> inactive <i>seconds</i>} Example: Router(config)# ipv6 flow-cache timeout active 10	Changes the timeout values for the NetFlow cache.
Step 5	ipv6 flow-aggregation cache {as bgp-nexthop destination-prefix prefix protocol-port source-prefix} Example: Router(config)# ipv6 flow-aggregation cache as	Configures the aggregation cache configuration scheme.

Managing NetFlow Statistics

You can display and clear NetFlow statistics. NetFlow statistics consist of IP packet size distribution, IP flow cache information, and flow information such as the protocol, total flow, and flows per second. The resulting information can be used to determine information about your router traffic.

The following task describes how to manage NetFlow statistics. Use these commands as needed for verification of configuration.

SUMMARY STEPS

1. `enable`
1. `show ip cache flow`
2. `clear ip flow stats`

DETAILED STEPS

	Command or Action	Purpose
Step 1	<code>enable</code> Example: Router> enable	Enables privileged EXEC mode. <ul style="list-style-type: none"> Enter your password if prompted.
Step 2	<code>show ip cache flow</code> Example: Router# show ip cache flow	Displays NetFlow statistics.
Step 3	<code>clear ip flow stats</code> Example: Router# clear ip flow stats	Clears the NetFlow statistics.

Configuring an Aggregation Cache

The following task describes how to configure an aggregation cache for NetFlow.

Prerequisites

To configure an aggregation cache, you must enter aggregation cache configuration mode, and you must decide which type of aggregation scheme you want to configure: Autonomous System, Destination Prefix, Prefix, Protocol Prefix, or Source Prefix aggregation cache. Once you define the aggregation scheme, the following task lets you define the operational parameters for that scheme.

SUMMARY STEPS

- `enable`
- `configure terminal`
- `ipv6 flow-export destination ip-address udp-port`
- `ipv6 flow-aggregation cache {as | bgp-nexthop | destination-prefix | prefix | protocol-port | source-prefix}`
- `cache {entries number | timeout {active minutes | inactive seconds}}`
- `cache {entries number | timeout {active minutes | inactive seconds}}`
- `exit`
- `ipv6 flow-export destination ip-address udp-port`

DETAILED STEPS

	Command	Purpose
Step 1	<p>enable</p> <p>Example: Router> enable</p>	<p>Enables privileged EXEC mode.</p> <ul style="list-style-type: none"> Enter your password if prompted.
Step 2	<p>configure terminal</p> <p>Example: Router# configure terminal</p>	<p>Enters global configuration mode.</p>
Step 3	<p>ipv6 flow-export destination <i>ip-address</i> <i>udp-port</i></p> <p>Example: Router(config)# ipv6 flow-export destination 10.42.42.1 9991</p>	<p>Enables the exporting of information in NetFlow cache entries to a specific address or port.</p>
Step 4	<p>ipv6 flow-aggregation cache {as bgp-nexthop destination-prefix prefix protocol-port source-prefix}</p> <p>Example: Router(config)# ipv6 flow-aggregation cache as</p>	<p>Configures the aggregation cache configuration scheme, and places the router in NetFlow aggregation cache configuration mode.</p>
Step 5	<p>cache {entries number timeout {active <i>minutes</i> inactive seconds}}</p> <p>Example: Router(config-flow-cache)# cache entries 2046</p>	<p>Specifies the number (in this example, 2046) of cache entries to allocate for the Autonomous System aggregation cache.</p>
Step 6	<p>cache {entries number timeout {active <i>minutes</i> inactive seconds}}</p> <p>Example: Router(config-flow-cache)# cache timeout inactive 199</p>	<p>Specifies the number of seconds (in this example, 199) that an inactive entry is allowed to remain in the aggregation cache before it is deleted.</p>
Step 7	<p>exit</p> <p>Example: Router(config-flow-cache)# exit</p>	<p>Exits NetFlow aggregation cache configuration mode, and places the router in global configuration mode.</p>
Step 8	<p>ipv6 flow-export destination <i>ip-address</i> <i>udp-port</i></p> <p>Example: Router(config)# ipv6 flow-export destination 10.0.101.254 9991</p>	<p>Enables the data export.</p>

Configuring a NetFlow Minimum Prefix Mask for Router-Based Aggregation

To configure the NetFlow Minimum Prefix Mask for Router-Based Aggregation feature, perform the tasks described in the following sections. Each task is optional.

- [Configuring the Minimum Mask of a Prefix Aggregation Scheme, page 410](#)
- [Configuring the Minimum Mask of a Destination-Prefix Aggregation Scheme, page 411](#)
- [Configuring the Minimum Mask of a Source-Prefix Aggregation Scheme, page 411](#)

Configuring the Minimum Mask of a Prefix Aggregation Scheme

The following task describes how to configure the minimum mask of a prefix aggregation scheme.

SUMMARY STEPS

1. **enable**
2. **configure terminal**
3. **ipv6 flow-aggregation cache {as | bgp-nextthop | destination-prefix | prefix | protocol-port | source-prefix}**
4. **mask {destination | source} minimum value**

DETAILED STEPS

	Command	Purpose
Step 1	enable Example: Router> enable	Enables privileged EXEC mode. <ul style="list-style-type: none">• Enter your password if prompted.
Step 2	configure terminal Example: Router# configure terminal	Enters global configuration mode.
Step 3	ipv6 flow-aggregation cache {as bgp-nextthop destination-prefix prefix protocol-port source-prefix} Example: Router(config)# ipv6 flow-aggregation cache prefix	Configures the aggregation cache configuration scheme, and places the router in NetFlow aggregation cache configuration mode.
Step 4	mask {destination source} minimum value Example: Router(config-flow-cache)# mask source minimum value	Specifies the minimum value for the source mask.

Configuring the Minimum Mask of a Destination-Prefix Aggregation Scheme

The following task describes how to configure the minimum mask of a destination-prefix aggregation scheme.

SUMMARY STEPS

1. **enable**
2. **configure terminal**
3. **ipv6 flow-aggregation cache {as | bgp-next-hop | destination-prefix | prefix | protocol-port | source-prefix}**
4. **mask {destination | source} minimum *value***

DETAILED STEPS

	Command	Purpose
Step 1	enable Example: Router> enable	Enables privileged EXEC mode. <ul style="list-style-type: none"> • Enter your password if prompted.
Step 2	configure terminal Example: Router# configure terminal	Enters global configuration mode.
Step 3	ipv6 flow-aggregation cache {as bgp-next-hop destination-prefix prefix protocol-port source-prefix} Example: Router(config)# ipv6 flow-aggregation cache destination-prefix	Configures the aggregation cache configuration scheme, and places the router in NetFlow aggregation cache configuration mode.
Step 4	mask {destination source} minimum <i>value</i> Example: Router(config-flow-cache)# mask destination minimum 32	Specifies the minimum value for the destination mask.

Configuring the Minimum Mask of a Source-Prefix Aggregation Scheme

The following task describes how to configure the minimum mask of a source-prefix aggregation scheme.



Note

If the minimum mask has not been explicitly configured, no minimum mask information is displayed. The default value of the minimum mask is zero. The configurable range for the minimum mask is from 1 to 32. An appropriate value should be chosen by the user depending on the traffic. A higher value of the minimum mask will provide more detailed network addresses, but it may also result in increased number of flows in the aggregation cache.

SUMMARY STEPS

1. **enable**
2. **configure terminal**
3. **ipv6 flow-aggregation cache {as | bgp-next-hop | destination-prefix | prefix | protocol-port | source-prefix}**
4. **mask {destination | source} minimum value**

DETAILED STEPS

	Command	Purpose
Step 1	enable Example: Router> enable	Enables privileged EXEC mode. <ul style="list-style-type: none"> • Enter your password if prompted.
Step 2	configure terminal Example: Router# configure terminal	Enters global configuration mode.
Step 3	ipv6 flow-aggregation cache {as bgp-next-hop destination-prefix prefix protocol-port source-prefix} Example: Router(config)# ipv6 flow-aggregation cache source-prefix	Configure the aggregation cache configuration scheme, and places the router in NetFlow aggregation cache configuration mode.
Step 4	mask {destination source} minimum value Example: Router(config-flow-cache)# mask source minimum 5	Specifies the minimum value for the source mask.

Configuration Examples for Implementing NetFlow for IPv6

The section provides the following configuration example:

- [Configuring NetFlow in IPv6 Environments: Example, page 412](#)

Configuring NetFlow in IPv6 Environments: Example

If you configure the **ipv6 flow ingress** command on a few selected subinterfaces and then configure the **ip route-cache flow** command on the main interface, enabling the main interface will overwrite the **ip flow ingress** command and data collection will start from the main interface and from all the subinterfaces. In a scenario where you configure the **ipv6 flow ingress** command and then configure the **ip route-cache flow** command on the main interface, you can restore subinterface data collection by

using the **no ip route-cache flow** command. This configuration will disable data collection from the main interface and restore data collection to the subinterfaces you originally configured with the **ipv6 flow ingress** command.

The following example shows how to configure NetFlow on Fast Ethernet subinterface 6/3.0:

```
Router(config)# interface FastEthernet6/3.0
Router(config-subif)# ipv6 flow ingress
```

The following example shows the configuration for a loopback source interface. The loopback interface has the IPv6 address 2001:0DB8:1:1:FFFF:FFFF:FFFF:FFFE/64 and is used by the serial interface in slot 5, port 0.

```
Router# configure terminal
Router(config)# interface loopback 0
Router(config-if)# ipv6 address 2001:0DB8:1:1:FFFF:FFFF:FFFF:FFFE/64
Router(config-if)# exit
Router(config)# interface serial 5/0:0
Router(config-if)# ip unnumbered loopback0
Router(config-if)# encapsulation ppp
Router(config-if)# ipv6 flow cache
Router(config-if)# exit
Router(config)# ipv6 flow-export source loopback 0
Router(config)# exit
```

The following example shows a router configured to capture the first 64 bits of the source address for packets entering this interface:

```
Router(config)# interface FastEthernet 6/3.0
Router(config-subif)# ipv6 flow mask source maximum 64
```

Where to Go Next

If you want to implement IPv6 routing protocols, refer to the *Implementing RIP for IPv6*, *Implementing IS-IS for IPv6*, or *Implementing Multiprotocol BGP for IPv6* modules.

Additional References

The following sections provide references related to implementing NetFlow for IPv6.

Related Documents

Related Topic	Document Title
NetFlow for IPv6 commands	<i>Cisco IOS IPv6 Command Reference</i>
NetFlow for IPv4	<i>Cisco IOS NetFlow Configuration Guide</i> , Release 12.4
NetFlow for IPv4 commands: complete command syntax, command mode, defaults, usage guidelines, and examples	<i>Cisco IOS NetFlow Command Reference</i> , Release 12.4
IPv6 supported feature list	<i>Start Here: Cisco IOS Software Release Specifics for IPv6 Features</i>

Standards

Standard	Title
No new or modified standards are supported by this feature, and support for existing standards has not been modified by this feature.	—

MIBs

MIB	MIBs Link
	To locate and download MIBs for selected platforms, Cisco IOS releases, and feature sets, use Cisco MIB Locator found at the following URL: http://www.cisco.com/go/mibs

RFCs

RFC	Title
No new or modified RFCs are supported by this feature, and support for existing RFCs has not been modified by this feature.	—

Technical Assistance

Description	Link
The Cisco Technical Support & Documentation website contains thousands of pages of searchable technical content, including links to products, technologies, solutions, technical tips, and tools. Registered Cisco.com users can log in from this page to access even more content.	http://www.cisco.com/techsupport

Feature Information for Implementing NetFlow for IPv6

Table 23 lists the features in this module and provides links to specific configuration information. Only features that were introduced or modified in Cisco IOS Release 12.2(2)T or a later release appear in the table.

For information on a feature in this technology that is not documented here, see “Start Here: Cisco IOS Software Release Specifies for IPv6 Features.”

Not all commands may be available in your Cisco IOS software release. For release information about a specific command, see the command reference documentation.

Cisco IOS software images are specific to a Cisco IOS software release, a feature set, and a platform. Use Cisco Feature Navigator to find information about platform support and Cisco IOS software image support. Access Cisco Feature Navigator at <http://www.cisco.com/go/fn>. You must have an account on Cisco.com. If you do not have an account or have forgotten your username or password, click **Cancel** at the login dialog box and follow the instructions that appear.



Note

Table 23 lists only the Cisco IOS software release that introduced support for a given feature in a given Cisco IOS software release train. Unless noted otherwise, subsequent releases of that Cisco IOS software release train also support that feature.

Table 23 Feature Information for Implementing NetFlow for IPv6

Feature Name	Releases	Feature Information
IPv6: NetFlow for IPv6	12.3(7)T, 12.4, 12.4(2)T	<p>NetFlow enables you to collect traffic flow statistics on your routing devices and analyze traffic patterns, which are used to detect DoS attacks.</p> <p>The following sections provide information about this feature:</p> <ul style="list-style-type: none"> • NetFlow for IPv6 Environments, page 404 • How to Implement NetFlow for IPv6, page 404



Implementing OSPF for IPv6

The *Implementing OSPF for IPv6* module expands on OSPF to provide support for IPv6 routing prefixes. This module describes the concepts and tasks you need to implement OSPF for IPv6 on your network.

Finding Support Information for Platforms and Cisco IOS Software Images

Use Cisco Feature Navigator to find information about platform support and Cisco IOS software image support. Access Cisco Feature Navigator at <http://www.cisco.com/go/fn>. You must have an account on Cisco.com. If you do not have an account or have forgotten your username or password, click **Cancel** at the login dialog box and follow the instructions that appear.

Contents

- [Prerequisites for Implementing OSPF for IPv6, page 417](#)
- [Restrictions for Implementing OSPF for IPv6, page 418](#)
- [Information About Implementing OSPF for IPv6, page 418](#)
- [How to Implement OSPF for IPv6, page 423](#)
- [Configuration Examples for Implementing OSPF for IPv6, page 436](#)
- [Additional References, page 438](#)

Prerequisites for Implementing OSPF for IPv6

Before you enable OSPF for IPv6 on an interface, you must do the following:

- Complete the OSPF network strategy and planning for your IPv6 network. For example, you must decide whether multiple areas are required.
- Enable IPv6 unicast routing.
- Enable IPv6 on the interface.
- Configure the IP Security (IPSec) secure socket application program interface (API) on OSPF for IPv6 in order to enable authentication and encryption.

This document assumes that you are familiar with IPv4. Refer to the publications referenced in the “[Related Documents](#)” section for IPv4 configuration and command reference information. [Table 24](#) identifies the earliest release for each early-deployment train in which the feature became available.

Table 24 Minimum Required Cisco IOS Release

Feature	Minimum Required Cisco IOS Release by Release Train
OSPF Version 3 expands on OSPF Version 2	12.2(15)T, 12.0(24)S, 12.2(18)S, 12.3, 12.3(2)T, 12.4, 12.4(2)T, 12.2(28)SB, 12.2(33)SRA
Link-state advertisement (LSA) types in OSPF for IPv6	12.2(15)T, 12.0(24)S, 12.2(18)S, 12.3, 12.3(2)T, 12.4, 12.4(2)T, 12.2(28)SB
Nonbroadcast multiaccess (NBMA) interfaces in OSPF for IPv6	12.2(15)T, 12.0(24)S, 12.2(18)S, 12.3, 12.3(2)T, 12.4, 12.4(2)T, 12.2(28)SB
Force shortest path first (SPF) in OSPF for IPv6	12.2(15)T, 12.0(24)S, 12.2(18)S, 12.3, 12.3(2)T, 12.4, 12.4(2)T, 12.2(28)SB
Load balancing in OSPF for IPv6	12.2(15)T, 12.0(24)S, 12.2(18)S, 12.3, 12.3(2)T, 12.4, 12.4(2)T, 12.2(28)SB
Addresses on an interface in OSPF for IPv6	12.2(15)T, 12.0(24)S, 12.2(18)S, 12.3, 12.3(2)T, 12.4, 12.4(2)T, 12.2(28)SB
OSPF for IPv6 authentication support with IPsec	12.3(4)T, 12.4, 12.4(2)T
OSPFv3 IPsec encapsulating security payload (ESP) encryption and authentication	12.4(9)T

Restrictions for Implementing OSPF for IPv6

- When running a dual-stack IP network with OSPF version 2 for IPv4 and OSPF for IPv6, be careful when changing the defaults for commands used to enable OSPF for IPv6. Changing these defaults may affect your OSPF for IPv6 network, possibly adversely.
- Authentication is supported as of Cisco IOS Release 12.3(4)T.
- ESP authentication and encryption are supported as of Cisco IOS Release 12.4(9)T.

Information About Implementing OSPF for IPv6

To implement OSPF for IPv6, you need to understand the following concepts:

- [How OSPF for IPv6 Works, page 419](#)
- [Comparison of OSPF for IPv6 and OSPF Version 2, page 419](#)
- [LSA Types for IPv6, page 420](#)
- [Force SPF in OSPF for IPv6, page 421](#)
- [Load Balancing in OSPF for IPv6, page 421](#)
- [Importing Addresses into OSPF for IPv6, page 422](#)
- [OSPF for IPv6 Customization, page 422](#)
- [OSPF for IPv6 Authentication Support with IPsec, page 422](#)

How OSPF for IPv6 Works

OSPF is a routing protocol for IP. It is a link-state protocol, as opposed to a distance-vector protocol. Think of a link as being an interface on a networking device. A link-state protocol makes its routing decisions based on the states of the links that connect source and destination machines. The state of a link is a description of that interface and its relationship to its neighboring networking devices. The interface information includes the IPv6 prefix of the interface, the network mask, the type of network it is connected to, the routers connected to that network, and so on. This information is propagated in various type of LSAs.

A router's collection of LSA data is stored in a link-state database. The contents of the database, when subjected to the Dijkstra algorithm, result in the creation of the OSPF routing table. The difference between the database and the routing table is that the database contains a complete collection of raw data; the routing table contains a list of shortest paths to known destinations via specific router interface ports.

OSPF version 3, which is described in RFC 2740, supports IPv6.

Comparison of OSPF for IPv6 and OSPF Version 2

Much of the OSPF for IPv6 feature is the same as in OSPF version 2. OSPF version 3 for IPv6, which is described in RFC 2740, expands on OSPF version 2 to provide support for IPv6 routing prefixes and the larger size of IPv6 addresses.

In OSPF for IPv6, a routing process does not need to be explicitly created. Enabling OSPF for IPv6 on an interface will cause a routing process, and its associated configuration, to be created.

In OSPF for IPv6, each interface must be enabled using commands in interface configuration mode. This feature is different from OSPF version 2, in which interfaces are indirectly enabled using the router configuration mode.

When using an NBMA interface in OSPF for IPv6, users must manually configure the router with the list of neighbors. Neighboring routers are identified by their router ID.

In IPv6, users can configure many address prefixes on an interface. In OSPF for IPv6, all address prefixes on an interface are included by default. Users cannot select some address prefixes to be imported into OSPF for IPv6; either all address prefixes on an interface are imported, or no address prefixes on an interface are imported.

Unlike OSPF version 2, multiple instances of OSPF for IPv6 can be run on a link.

In OSPF for IPv6, it is possible that no IPv4 addresses will be configured on any interface. In this case, the user must use the **router-id** command to configure a router ID before the OSPF process will be started. A router ID is a 32-bit opaque number. OSPF version 2 takes advantage of the 32-bit IPv4 address to pick an IPv4 address as the router ID. If an IPv4 address does exist when OSPF for IPv6 is enabled on an interface, then that IPv4 address is used for the router ID. If more than one IPv4 address is available, a router ID is chosen using the same rules as for OSPF version 2.

OSPF automatically prefers a loopback interface over any other kind, and it chooses the highest IP address among all loopback interfaces. If no loopback interfaces are present, the highest IP address in the router is chosen. You cannot tell OSPF to use any particular interface.

For further information about configuring a router ID and the **router-id** command, refer to “Configuring OSPF” chapter of the *Cisco IOS IP Configuration Guide* and *Cisco IOS IP Command Reference, Volume 2 of 4: Routing Protocols*, Release 12.4.

LSA Types for IPv6

The following list describes LSA types, each of which has a different purpose:

- Router LSAs (Type 1)—Describes the link state and costs of a router's links to the area. These LSAs are flooded within an area only. The LSA indicates if the router is an Area Border Router (ABR) or Autonomous System Boundary Router (ASBR), and if it is one end of a virtual link. Type 1 LSAs are also used to advertise stub networks. In OSPF for IPv6, these LSAs have no address information and are network-protocol-independent. In OSPF for IPv6, router interface information may be spread across multiple router LSAs. Receivers must concatenate all router LSAs originated by a given router when running the SPF calculation.
- Network LSAs (Type 2)—Describes the link-state and cost information for all routers attached to the network. This LSA is an aggregation of all the link-state and cost information in the network. Only a designated router tracks this information and can generate a network LSA. In OSPF for IPv6, network LSAs have no address information and are network-protocol-independent.
- Interarea-prefix LSAs for ABRs (Type 3)—Advertises internal networks to routers in other areas (interarea routes). Type 3 LSAs may represent a single network or a set of networks summarized into one advertisement. Only ABRs generate summary LSAs. In OSPF for IPv6, addresses for these LSAs are expressed as *prefix, prefix length* instead of *address, mask*. The default route is expressed as a prefix with length 0.
- Interarea-router LSAs for ASBRs (Type 4)—Advertise the location of an ASBR. Routers that are trying to reach an external network use these advertisements to determine the best path to the next hop. ASBRs generate Type 4 LSAs.
- Autonomous system external LSAs (Type 5)—Redistributes routes from another AS, usually from a different routing protocol into OSPF. In OSPF for IPv6, addresses for these LSAs are expressed as *prefix, prefix length* instead of *address, mask*. The default route is expressed as a prefix with length 0.
- Link LSAs (Type 8)—Have local-link flooding scope and are never flooded beyond the link with which they are associated. Link LSAs provide the link-local address of the router to all other routers attached to the link, inform other routers attached to the link of a list of IPv6 prefixes to associate with the link, and allow the router to assert a collection of Options bits to associate with the network LSA that will be originated for the link.
- Intra-Area-Prefix LSAs (Type 9)—A router can originate multiple intra-area-prefix LSAs for each router or transit network, each with a unique link-state ID. The link-state ID for each intra-area-prefix LSA describes its association to either the router LSA or the network LSA and contains prefixes for stub and transit networks.

An address prefix occurs in almost all newly defined LSAs. The prefix is represented by three fields: PrefixLength, PrefixOptions, and Address Prefix. In OSPF for IPv6, addresses for these LSAs are expressed as *prefix, prefix length* instead of *address, mask*. The default route is expressed as a prefix with length 0. Type 3 and Type 9 LSAs carry all IPv6 prefix information that, in IPv4, is included in router LSAs and network LSAs. The Options field in certain LSAs (router LSAs, network LSAs, interarea-router LSAs, and link LSAs) has been expanded to 24 bits to provide support for OSPF in IPv6.

In OSPF for IPv6, the sole function of link-state ID in interarea-prefix LSAs, interarea-router LSAs, and autonomous-system external LSAs is to identify individual pieces of the link-state database. All addresses or router IDs that are expressed by the link-state ID in OSPF version 2 are carried in the body of the LSA in OSPF for IPv6.

The link-state ID in network LSAs and link LSAs is always the interface ID of the originating router on the link being described. For this reason, network LSAs and link LSAs are now the only LSAs whose size cannot be limited. A network LSA must list all routers connected to the link, and a link LSA must list all of the address prefixes of a router on the link.

NBMA in OSPF for IPv6

On NBMA networks, the designated router (DR) or backup DR (BDR) performs the LSA flooding. On point-to-point networks, flooding simply goes out an interface directly to a neighbor.

Routers that share a common segment (Layer 2 link between two interfaces) become neighbors on that segment. OSPF uses the Hello protocol, periodically sending hello packets out each interface. Routers become neighbors when they see themselves listed in the neighbor's hello packet. After two routers become neighbors, they may proceed to exchange and synchronize their databases, which creates an adjacency. Not all neighboring routers have an adjacency.

On point-to-point and point-to-multipoint networks, the software floods routing updates to immediate neighbors. There is no DR or BDR; all routing information is flooded to each networking device.

On broadcast or NBMA segments only, OSPF minimizes the amount of information being exchanged on a segment by choosing one router to be a DR and one router to be a BDR. Thus, the routers on the segment have a central point of contact for information exchange. Instead of each router exchanging routing updates with every other router on the segment, each router exchanges information with the DR and BDR. The DR and BDR relay the information to the other routers.

The software looks at the priority of the routers on the segment to determine which routers will be the DR and BDR. The router with the highest priority is elected the DR. If there is a tie, then the router with the higher router ID takes precedence. After the DR is elected, the BDR is elected the same way. A router with a router priority set to zero is ineligible to become the DR or BDR.

When using NBMA in OSPF for IPv6, you cannot automatically detect neighbors. On an NBMA interface, you must configure your neighbors manually using interface configuration mode.

Force SPF in OSPF for IPv6

When the **process** keyword is used with the **clear ipv6 ospf** command, the OSPF database is cleared and repopulated, and then the SPF algorithm is performed. When the **force-spf** keyword is used with the **clear ipv6 ospf** command, the OSPF database is not cleared before the SPF algorithm is performed.

Load Balancing in OSPF for IPv6

When a router learns multiple routes to a specific network via multiple routing processes (or routing protocols), it installs the route with the lowest administrative distance in the routing table. Sometimes the router must select a route from among many learned via the same routing process with the same administrative distance. In this case, the router chooses the path with the lowest cost (or metric) to the destination. Each routing process calculates its cost differently and the costs may need to be manipulated in order to achieve load balancing.

OSPF performs load balancing automatically in the following way. If OSPF finds that it can reach a destination through more than one interface and each path has the same cost, it installs each path in the routing table. The only restriction on the number of paths to the same destination is controlled by the **maximum-paths** command. The default maximum paths is 16, and the range is from 1 to 64.

Importing Addresses into OSPF for IPv6

When importing the set of addresses specified on an interface on which OSPF for IPv6 is running into OSPF for IPv6, users cannot select specific addresses to be imported. Either all addresses are imported, or no addresses are imported.

OSPF for IPv6 Customization

You can customize OSPF for IPv6 for your network, but you likely will not need to do so. The defaults for OSPF in IPv6 are set to meet the requirements of most customers and features. If you must change the defaults, refer to the IPv4 configuration guide and the IPv6 command reference to find the appropriate syntax.



Caution

Be careful when changing the defaults. Changing defaults will affect your OSPF for IPv6 network, possibly adversely.

OSPF for IPv6 Authentication Support with IPsec

In order to ensure that OSPF for IPv6 packets are not altered and re-sent to the router, causing the router to behave in a way not desired by its managers, OSPF for IPv6 packets must be authenticated. OSPF for IPv6 uses the IP Security (IPsec) secure socket application program interface (API) to add authentication to OSPF for IPv6 packets. This API has been extended to provide support for IPv6.

OSPF for IPv6 requires the use of IPsec to enable authentication. Crypto images are required to use authentication, because only crypto images include the IPsec API needed for use with OSPF for IPv6.

In OSPF for IPv6, authentication fields have been removed from OSPF headers. When OSPF runs on IPv6, OSPF requires the IPv6 authentication header (AH) or IPv6 ESP header to ensure integrity, authentication, and confidentiality of routing exchanges. IPv6 AH and ESP extension headers can be used to provide authentication and confidentiality to OSPF for IPv6.

To use the IPsec AH, you must enable the **ipv6 ospf authentication** command. To use the IPsec ESP, you must enable the **ipv6 ospf encryption** command. The ESP header may be applied alone or in combination with the AH, and when ESP is used, both encryption and authentication are provided. Security services can be provided between a pair of communicating hosts, between a pair of communicating security gateways, or between a security gateway and a host.

To configure IPsec, users configure a security policy, which is a combination of the security policy index (SPI) and the key (the key is used to create and validate the hash value). IPsec for OSPF for IPv6 can be configured on an interface or on an OSPF area. For higher security, users should configure a different policy on each interface configured with IPsec. If a user configures IPsec for an OSPF area, the policy is applied to all of the interfaces in that area, except for the interfaces that have IPsec configured directly. Once IPsec is configured for OSPF for IPv6, IPsec is invisible to the user.

The secure socket API is used by applications to secure traffic. The API needs to allow the application to open, listen, and close secure sockets. The binding between the application and the secure socket layer also allows the secure socket layer to inform the application of changes to the socket, such as connection open and close events. The secure socket API is able to identify the socket; that is, it can identify the local and remote addresses, masks, ports, and protocol that carry the traffic requiring security.

Each interface has a secure socket state, which can be one of the following:

- NULL: Do not create a secure socket for the interface if authentication is configured for the area.

- **DOWN:** IPsec has been configured for the interface (or the area that contains the interface), but OSPF for IPv6 either has not requested IPsec to create a secure socket for this interface, or there is an error condition.
- **GOING UP:** OSPF for IPv6 has requested a secure socket from IPsec and is waiting for a CRYPTO_SS_SOCKET_UP message from IPsec.
- **UP:** OSPF has received a CRYPTO_SS_SOCKET_UP message from IPsec.
- **CLOSING:** The secure socket for the interface has been closed. A new socket may be opened for the interface, in which case the current secure socket makes the transition to the DOWN state. Otherwise, the interface will become UNCONFIGURED.
- **UNCONFIGURED:** Authentication is not configured on the interface.

OSPF will not send or accept packets while in the DOWN state.

For further information on IPsec, refer to the *Implementing IPsec in IPv6 Security* document.

OSPF for IPv6 Virtual Links

For each virtual link, a master security information datablock is created for the virtual link. Because a secure socket must be opened on each interface, there will be a corresponding security information datablock for each interface in the transit area. The secure socket state is kept in the interface's security information datablock. The state field in the master security information datablock reflects the status of all of the secure sockets opened for the virtual link. If all of the secure sockets are UP, then the security state for the virtual link will be set to UP.

Packets sent on a virtual link with IPsec must use predetermined source and destination addresses. The first local area address found in the router's intra-area-prefix LSA for the area is used as the source address. This source address is saved in the area data structure and used when secure sockets are opened and packets sent over the virtual link. The virtual link will not transition to the point-to-point state until a source address is selected. Also, when the source or destination address changes, the previous secure sockets must be closed and new secure sockets opened.

For further information on IPsec and how to implement it, refer to the *Implementing Security for IPv6* module.

How to Implement OSPF for IPv6

This section contains the following procedures:

- [Enabling OSPF for IPv6 on an Interface, page 423](#) (required)
- [Defining an OSPF for IPv6 Area Range, page 424](#) (optional)
- [Configuring IPsec on OSPF for IPv6, page 425](#) (optional)
- [Configuring NBMA Interfaces, page 430](#) (optional)
- [Forcing an SPF Calculation, page 431](#) (optional)
- [Verifying OSPF for IPv6 Configuration and Operation, page 432](#) (optional)

Enabling OSPF for IPv6 on an Interface

This task explains how to enable OSPF for IPv6 routing and configure OSPF for IPv6 on each interface. By default, OSPF for IPv6 routing is disabled and OSPF for IPv6 is not configured on an interface.

SUMMARY STEPS

1. **enable**
2. **configure terminal**
3. **interface** *type number*
4. **ipv6 ospf** *process-id area area-id [instance instance-id]*

DETAILED STEPS

	Command or Action	Purpose
Step 1	enable Example: Router> enable	Enables privileged EXEC mode. <ul style="list-style-type: none"> • Enter your password if prompted.
Step 2	configure terminal Example: Router# configure terminal	Enters global configuration mode.
Step 3	interface <i>type number</i> Example: Router(config)# interface ethernet 0/0	Specifies an interface type and number, and places the router in interface configuration mode.
Step 4	ipv6 ospf <i>process-id area area-id [instance instance-id]</i> Example: Router(config-if)# ipv6 ospf 1 area 0	Enables OSPF for IPv6 on an interface.

Defining an OSPF for IPv6 Area Range

The cost of the summarized routes will be the highest cost of the routes being summarized. For example, if the following routes are summarized:

```
OI 2001:0DB8:0:0:7::/64 [110/20]
   via FE80::A8BB:CCFF:FE00:6F00, Ethernet0/0
OI 2001:0DB8:0:0:8::/64 [110/100]
   via FE80::A8BB:CCFF:FE00:6F00, Ethernet0/0
OI 2001:0DB8:0:0:9::/64 [110/20]
   via FE80::A8BB:CCFF:FE00:6F00, Ethernet0/0
```

They become one summarized route, as follows:

```
OI 2001:0DB8::/48 [110/100]
   via FE80::A8BB:CCFF:FE00:6F00, Ethernet0/0
```

This task explains how to consolidate or summarize routes for an OSPF area.

Prerequisites

OSPF for IPv6 routing must be enabled.

SUMMARY STEPS

1. **enable**
2. **configure terminal**
3. **ipv6 router ospf process-id**
4. **area area-id range ipv6-prefix/prefix-length [advertise | not-advertise] [cost cost]**

DETAILED STEPS

	Command or Action	Purpose
Step 1	enable Example: Router> enable	Enables privileged EXEC mode. <ul style="list-style-type: none">• Enter your password if prompted.
Step 2	configure terminal Example: Router# configure terminal	Enters global configuration mode.
Step 3	ipv6 router ospf process-id Example: Router(config)# ipv6 router ospf 1	Enables OSPF router configuration mode.
Step 4	area area-id range ipv6-prefix/prefix-length [advertise not-advertise] [cost cost] Example: Router(config-rtr)# area range 1 2001:0DB8::/48	Consolidates and summarizes routes at an area boundary.

Configuring IPsec on OSPF for IPv6

Once you have configured OSPF for IPv6 and decided on your authentication, you must define the security policy on each of the routers within the group. The security policy consists of the combination of the key and the SPI. To define a security policy, you must define an SPI and a key.

You can configure an authentication or encryption policy either on an interface or for an OSPF area. When you configure for an area, the security policy is applied to all of the interfaces in the area. For higher security, use a different policy on each interface.

You can configure authentication and encryption on virtual links.

The following tasks explain how to configure authentication and encryption on an interface or in an OSPF area, and on virtual links.

- [Defining Authentication on an Interface, page 426](#)
- [Defining Encryption on an Interface, page 426](#)

- [Defining Authentication in an OSPF Area, page 427](#)
- [Defining Encryption in an OSPF Area, page 428](#)
- [Defining Authentication and Encryption for a Virtual Link in an OSPF Area, page 429](#)

Defining Authentication on an Interface

This task explains how to define authentication on an interface.

Prerequisites

Before you configure IPSec on an interface, you must configure OSPF for IPv6 on that interface.

SUMMARY STEPS

1. **enable**
2. **configure terminal**
3. **interface** *type number*
4. **ipv6 ospf authentication ipsec spi** *spi md5* [*key-encryption-type* {*key* | **null**}]

DETAILED STEPS

	Command or Action	Purpose
Step 1	enable Example: Router> enable	Enables privileged EXEC mode. <ul style="list-style-type: none"> • Enter your password if prompted.
Step 2	configure terminal Example: Router# configure terminal	Enters global configuration mode.
Step 3	interface <i>type number</i> Example: Router(config)# interface ethernet 0/0	Specifies an interface type and number, and places the router in interface configuration mode.
Step 4	ipv6 ospf authentication ipsec spi <i>spi md5</i> [<i>key-encryption-type</i> { <i>key</i> null }] Example: Router(config-if)# ipv6 ospf authentication ipsec spi 500 md5 1234567890abcdef1234567890abcdef	Specifies the authentication type for an interface.

Defining Encryption on an Interface

This task describes how to define encryption on an interface.

Prerequisites

Before you configure IPsec on an interface, you must configure OSPF for IPv6 on that interface.

SUMMARY STEPS

1. **enable**
2. **configure terminal**
3. **interface** *type number*
4. **ipv6 ospf encryption** {**ipsec spi spi esp** *encryption-algorithm* [[*key-encryption-type*] *key*] *authentication-algorithm* [*key-encryption-type*] *key* | **null**}

DETAILED STEPS

	Command or Action	Purpose
Step 1	enable Example: Router> enable	Enables privileged EXEC mode. <ul style="list-style-type: none"> • Enter your password if prompted.
Step 2	configure terminal Example: Router# configure terminal	Enters global configuration mode.
Step 3	interface <i>type number</i> Example: Router(config)# interface ethernet 0/0	Specifies an interface type and number, and places the router in interface configuration mode.
Step 4	ipv6 ospf encryption { ipsec spi spi esp <i>encryption-algorithm</i> [[<i>key-encryption-type</i>] <i>key</i>] <i>authentication-algorithm</i> [<i>key-encryption-type</i>] <i>key</i> null } Example: Router(config-if) ipv6 ospf encryption ipsec spi 1001 esp null sha1 123456789A123456789B123456789C123456789D	Specifies the encryption type for an interface.

Defining Authentication in an OSPF Area

This task explains how to define authentication in an OSPF area.

SUMMARY STEPS

1. **enable**
2. **configure terminal**
3. **ipv6 router ospf** *process-id*
4. **area** *area-id* **authentication ipsec spi spi md5** [*key-encryption-type*] *key*

DETAILED STEPS

	Command or Action	Purpose
Step 1	enable Example: Router> enable	Enables privileged EXEC mode. <ul style="list-style-type: none"> Enter your password if prompted.
Step 2	configure terminal Example: Router# configure terminal	Enters global configuration mode.
Step 3	ipv6 router ospf process-id Example: Router(config)# ipv6 router ospf 1	Enables OSPF router configuration mode.
Step 4	area area-id authentication ipsec spi spi md5 [key-encryption-type] key Example: Router(config-rtr)# area 1 authentication ipsec spi 678 md5 1234567890ABCDEF1234567890ABCDEF	Enables authentication in an OSPF area.

Defining Encryption in an OSPF Area

This task describes how to define encryption in an OSPF area.

SUMMARY STEPS

- enable**
- configure terminal**
- ipv6 router ospf process-id**
- area area-id encryption ipsec spi spi esp encryption-algorithm** [[key-encryption-type] key] authentication-algorithm [key-encryption-type] key

DETAILED STEPS

	Command or Action	Purpose
Step 1	enable Example: Router> enable	Enables privileged EXEC mode. <ul style="list-style-type: none"> Enter your password if prompted.
Step 2	configure terminal Example: Router# configure terminal	Enters global configuration mode.

	Command or Action	Purpose
Step 3	<code>ipv6 router ospf process-id</code> Example: Router(config)# ipv6 router ospf 1	Enables OSPF router configuration mode.
Step 4	<code>area area-id encryption ipsec spi spi esp encryption-algorithm [[key-encryption-type] key] authentication-algorithm [key-encryption-type] key</code> Example: Router(config-rtr)# area 1 encryption ipsec spi 500 esp null md5 1aaa2bbb3ccc4ddd5eee6fff7aaa8bbb	Enables encryption in an OSPF area.

Defining Authentication and Encryption for a Virtual Link in an OSPF Area

The following task describes how to define authentication and encryption for virtual links in an OSPF area.

SUMMARY STEPS

1. **enable**
2. **configure terminal**
3. **ipv6 router ospf process-id**
4. **area area-id virtual-link router-id authentication ipsec spi spi authentication-algorithm [key-encryption-type] key**
5. **area area-id virtual-link router-id encryption ipsec spi spi esp encryption-algorithm [[key-encryption-type] key] authentication-algorithm [key-encryption-type] key**

DETAILED STEPS

	Command or Action	Purpose
Step 1	<code>enable</code> Example: Router> enable	Enables privileged EXEC mode. <ul style="list-style-type: none"> • Enter your password if prompted.
Step 2	<code>configure terminal</code> Example: Router# configure terminal	Enters global configuration mode.
Step 3	<code>ipv6 router ospf process-id</code> Example: Router(config)# ipv6 router ospf 1	Enables OSPF router configuration mode.

	Command or Action	Purpose
Step 4	<pre>area area-id virtual-link router-id authentication ipsec spi spi authentication-algorithm [key-encryption-type] key</pre> <p>Example:</p> <pre>Router(config-rtr)# area 1 virtual-link 10.0.0.1 authentication ipsec spi 940 md5 1234567890ABCDEF1234567890ABCDEF</pre>	Enables authentication for virtual links in an OSPF area.
Step 5	<pre>area area-id virtual-link router-id encryption ipsec spi spi esp encryption-algorithm [[key-encryption-type] key] authentication-algorithm [key-encryption-type] key</pre> <p>Example:</p> <pre>Router(config-rtr)# area 1 virtual-link 10.1.0.1 hello-interval 2 dead-interval 10 encryption ipsec spi 3944 esp null sha1 123456789A123456789B123456789C123456789D</pre>	Enables encryption for virtual links in an OSPF area.

Configuring NBMA Interfaces

You can customize OSPF for IPv6 in your network to use NBMA interfaces. OSPF for IPv6 cannot automatically detect neighbors over NBMA interfaces. On an NBMA interface, you must configure your neighbors manually using interface configuration mode. This task explains how to configure NBMA interfaces.

Prerequisites

Before you configure NBMA interfaces, you must perform the following tasks:

- Configure your network to be an NBMA network
- Identify each neighbor

Restrictions

- You cannot automatically detect neighbors when using NBMA interfaces. You must manually configure your router to detect neighbors when using an NBMA interface.
- When configuring the **ipv6 ospf neighbor** command, the IPv6 address used must be the link-local address of the neighbor.

SUMMARY STEPS

1. **enable**
2. **configure terminal**
3. **interface** *type number*

4. **frame-relay map ipv6** *ipv6-address dlci* [**broadcast**] [**cisco**] [**ietf**] [**payload-compression** {**packet-by-packet** | **frf9 stac** [*hardware-options*] | **data-stream stac** [*hardware-options*]}]
5. **ipv6 ospf neighbor** *ipv6-address* [**priority number**] [**poll-interval seconds**] [**cost number**] [**database-filter all out**]

DETAILED STEPS

	Command or Action	Purpose
Step 1	enable Example: Router> enable	Enables privileged EXEC mode. <ul style="list-style-type: none"> • Enter your password if prompted.
Step 2	configure terminal Example: Router# configure terminal	Enters global configuration mode.
Step 3	interface <i>type number</i> Example: Router(config)# interface serial 0	Specifies an interface type and number, and places the router in interface configuration mode.
Step 4	frame-relay map ipv6 <i>ipv6-address dlci</i> [broadcast] [cisco] [ietf] [payload-compression { packet-by-packet frf9 stac [<i>hardware-options</i>] data-stream stac [<i>hardware-options</i>]}] Example: Router(config-if)# frame-relay map ipv6 FE80::A8BB:CCFF:FE00:C01 120	Defines the mapping between a destination IPv6 address and the data-link connection identifier (DLCI) used to connect to the destination address. <ul style="list-style-type: none"> • In this example, the NBMA link is frame relay. For other kinds of NBMA links, different mapping commands are used.
Step 5	ipv6 ospf neighbor <i>ipv6-address</i> [priority number] [poll-interval seconds] [cost number] [database-filter all out] Example: Router(config-if) ipv6 ospf neighbor FE80::A8BB:CCFF:FE00:C01	Configures an OSPF for IPv6 neighboring router.

Forcing an SPF Calculation

This task explains how to start the SPF algorithm without first clearing the OSPF database.

SUMMARY STEPS

1. **enable**
2. **clear ipv6 ospf** [*process-id*] {**process** | **force-spf** | **redistribution**}

	Command or Action	Purpose
Step 1	enable Example: Router> enable	Enables privileged EXEC mode. <ul style="list-style-type: none"> Enter your password if prompted.
Step 2	clear ipv6 ospf [<i>process-id</i>] { process force-spf redistribution } Example: Router# clear ipv6 ospf force-spf	Clears the OSPF state based on the OSPF routing process ID.

Verifying OSPF for IPv6 Configuration and Operation

This task explains how to display information to verify the configuration and operation of OSPF for IPv6.

SUMMARY STEPS

1. **enable**
2. **show ipv6 ospf** [*process-id*] [*area-id*] **interface** [*interface-type interface-number*]
3. **show ipv6 ospf** [*process-id*] [*area-id*]
4. **show crypto ipsec policy** [**name** *policy-name*]
5. **show crypto ipsec sa** [**map** *map-name* | **address** | **identity** | **interface** *interface-type interface-number* | **peer** [**vrf** *fvr-f-name*] **address** | **vrf** *ivrf-name* | **ipv6** [*interface-type interface-number*]] [**detail**]

DETAILED STEPS

	Command or Action	Purpose
Step 1	enable Example: Router> enable	Enables privileged EXEC mode. <ul style="list-style-type: none"> Enter your password if prompted.
Step 2	show ipv6 ospf [<i>process-id</i>] [<i>area-id</i>] interface [<i>interface-type interface-number</i>] Example: Router# show ipv6 ospf interface	Displays OSPF-related interface information.
Step 3	show ipv6 ospf [<i>process-id</i>] [<i>area-id</i>] Example: Router# show ipv6 ospf	Displays general information about OSPF routing processes.

	Command or Action	Purpose
Step 4	<pre>show crypto ipsec policy [name policy-name]</pre> <p>Example: Router# show crypto ipsec policy</p>	Displays the parameters for each IPsec parameter.
Step 5	<pre>show crypto ipsec sa [map map-name address identity interface interface-type interface-number peer [vrf fvrf-name] address vrf ivrf-name ipv6 [interface-type interface-number]] [detail]</pre> <p>Example: Router# show crypto ipsec sa ipv6</p>	Displays the settings used by current security associations (SAs).

Examples

This section provides the following output examples:

- [Sample Output for the show ipv6 ospf interface Command, page 433](#)
- [Sample Output for the show ipv6 ospf Command, page 434](#)
- [Sample Output for the show crypto ipsec policy Command, page 435](#)
- [Sample Output for the show crypto ipsec sa ipv6 Command, page 435](#)

Sample Output for the show ipv6 ospf interface Command

The following is sample output from the **show ipv6 ospf interface** command with regular interfaces and a virtual link that are protected by encryption and authentication:

```
Router# show ipv6 ospf interface

OSPFv3_VL1 is up, line protocol is up
  Interface ID 69
  Area 0, Process ID 1, Instance ID 0, Router ID 10.0.0.1
  Network Type VIRTUAL_LINK, Cost: 64
  Configured as demand circuit.
  Run as demand circuit.
  DoNotAge LSA allowed.
  NULL encryption SHA-1 auth SPI 3944, secure socket UP (errors: 0)
  Transmit Delay is 1 sec, State POINT_TO_POINT,
  Timer intervals configured, Hello 2, Dead 10, Wait 40, Retransmit 5
    Hello due in 00:00:00
  Index 1/3/5, flood queue length 0
  Next 0x0(0)/0x0(0)/0x0(0)
  Last flood scan length is 1, maximum is 1
  Last flood scan time is 0 msec, maximum is 0 msec
  Neighbor Count is 1, Adjacent neighbor count is 1
    Adjacent with neighbor 10.2.0.1 (Hello suppressed)
  Suppress hello for 1 neighbor(s)
OSPFv3_VL0 is up, line protocol is up
  Interface ID 67
  Area 0, Process ID 1, Instance ID 0, Router ID 10.0.0.1
  Network Type VIRTUAL_LINK, Cost: 128
  Configured as demand circuit.
  Run as demand circuit.
  DoNotAge LSA allowed.
  MD5 authentication SPI 940, secure socket UP (errors: 0)
  Transmit Delay is 1 sec, State POINT_TO_POINT,
```

```

Timer intervals configured, Hello 10, Dead 40, Wait 40, Retransmit 5
  Hello due in 00:00:09
Index 1/2/4, flood queue length 0
Next 0x0(0)/0x0(0)/0x0(0)
Last flood scan length is 1, maximum is 10
Last flood scan time is 0 msec, maximum is 0 msec
Neighbor Count is 1, Adjacent neighbor count is 1
  Adjacent with neighbor 10.1.0.1 (Hello suppressed)
  Suppress hello for 1 neighbor(s)
Ethernet1/0 is up, line protocol is up
  Link Local Address FE80::A8BB:CCFF:FE00:6601, Interface ID 6
  Area 0, Process ID 1, Instance ID 0, Router ID 10.0.0.1
  Network Type BROADCAST, Cost: 10
  Transmit Delay is 1 sec, State DR, Priority 1
  Designated Router (ID) 10.0.0.1, local address FE80::A8BB:CCFF:FE00:6601
  No backup designated router on this network
  Timer intervals configured, Hello 10, Dead 40, Wait 40, Retransmit 5
    Hello due in 00:00:09
  Index 1/1/1, flood queue length 0
  Next 0x0(0)/0x0(0)/0x0(0)
  Last flood scan length is 0, maximum is 0
  Last flood scan time is 0 msec, maximum is 0 msec
  Neighbor Count is 0, Adjacent neighbor count is 0
  Suppress hello for 0 neighbor(s)
Serial12/0 is up, line protocol is up
  Link Local Address FE80::A8BB:CCFF:FE00:6600, Interface ID 50
  Area 1, Process ID 1, Instance ID 0, Router ID 10.0.0.1
  Network Type POINT_TO_POINT, Cost: 64
  AES-CBC encryption SHA-1 auth SPI 2503, secure socket UP (errors: 0)
  authentication NULL
  Transmit Delay is 1 sec, State POINT_TO_POINT,
  Timer intervals configured, Hello 10, Dead 40, Wait 40, Retransmit 5
    Hello due in 00:00:09
  Index 1/2/3, flood queue length 0
  Next 0x0(0)/0x0(0)/0x0(0)
  Last flood scan length is 1, maximum is 5
  Last flood scan time is 0 msec, maximum is 0 msec
  Neighbor Count is 1, Adjacent neighbor count is 1
    Adjacent with neighbor 10.2.0.1
  Suppress hello for 0 neighbor(s)
Serial11/0 is up, line protocol is up
  Link Local Address FE80::A8BB:CCFF:FE00:6600, Interface ID 46
  Area 1, Process ID 1, Instance ID 0, Router ID 10.0.0.1
  Network Type POINT_TO_POINT, Cost: 64
  MD5 authentication (Area) SPI 500, secure socket UP (errors: 0)
  Transmit Delay is 1 sec, State POINT_TO_POINT,
  Timer intervals configured, Hello 10, Dead 40, Wait 40, Retransmit 5
    Hello due in 00:00:09
  Index 1/1/2, flood queue length 0
  Next 0x0(0)/0x0(0)/0x0(0)
  Last flood scan length is 1, maximum is 5
  Last flood scan time is 0 msec, maximum is 0 msec
  Neighbor Count is 1, Adjacent neighbor count is 1
    Adjacent with neighbor 1.0.0.1
  Suppress hello for 0 neighbor(s)

```

Sample Output for the show ipv6 ospf Command

The following is sample output from the **show ipv6 ospf** command:

```

Router# show ipv6 ospf

Routing Process "ospfv3 1" with ID 172.16.3.3
  It is an autonomous system boundary router

```

```

Redistributing External Routes from,
  static
SPF schedule delay 5 secs, Hold time between two SPFs 10 secs
Minimum LSA interval 5 secs. Minimum LSA arrival 1 secs
LSA group pacing timer 240 secs
Interface flood pacing timer 33 msec
Retransmission pacing timer 66 msec
Number of external LSA 1. Checksum Sum 0x218D
Number of areas in this router is 1. 1 normal 0 stub 0 nssa
  Area 1
    Number of interfaces in this area is 2
    SPF algorithm executed 9 times
    Number of LSA 15. Checksum Sum 0x67581
    Number of DCbitless LSA 0
    Number of indication LSA 0
    Number of DoNotAge LSA 0
    Flood list length 0

```

Sample Output for the show crypto ipsec policy Command

The following is sample output from the **show crypto ipsec policy** command:

```

Router# show crypto ipsec policy

Crypto IPsec client security policy data

Policy name:      OSPFv3-1-1000
Policy refcount: 1
Inbound AH SPI:  1000 (0x3E8)
Outbound AH SPI: 1000 (0x3E8)
Inbound AH Key:  1234567890ABCDEF1234567890ABCDEF
Outbound AH Key: 1234567890ABCDEF1234567890ABCDEF
Transform set:   ah-md5-hmac

```

Sample Output for the show crypto ipsec sa ipv6 Command

The following is sample output from the **show crypto ipsec sa ipv6** command:

```

Router# show crypto ipsec sa ipv6

IPv6 IPsec SA info for interface Ethernet0/0

protected policy name:OSPFv3-1-1000
IPsec created ACL name:Ethernet0/0-ipsecv6-ACL

local ident (addr/prefixlen/proto/port):(FE80::/10/89/0)
remote ident (addr/prefixlen/proto/port):(::/0/89/0)
current_peer::
  PERMIT, flags={origin_is_acl,}
#pkts encaps:21, #pkts encrypt:0, #pkts digest:21
#pkts decaps:20, #pkts decrypt:0, #pkts verify:20
#pkts compressed:0, #pkts decompressed:0
#pkts not compressed:0, #pkts compr. failed:0
#pkts not decompressed:0, #pkts decompress failed:0
#send errors 0, #recv errors 0

local crypto endpt. ::, remote crypto endpt. ::
path mtu 1500, media mtu 1500
current outbound spi:0x3E8(1000)

inbound ESP SAs:

inbound AH SAs:
spi:0x3E8(1000)
transform:ah-md5-hmac ,

```

```

    in use settings =(Transport, )
    slot:0, conn_id:2000, flow_id:1, crypto map:N/R
    no sa timing (manual-keyed)
    replay detection support:N

inbound PCP SAs:

outbound ESP SAs:

outbound AH SAs:
spi:0x3E8(1000)
  transform:ah-md5-hmac ,
  in use settings =(Transport, )
  slot:0, conn_id:2001, flow_id:2, crypto map:N/R
  no sa timing (manual-keyed)
  replay detection support:N

outbound PCP SAs:

```

What to Do Next

For output examples of the commands used to verify OSPF for IPv6 configuration and operation, refer to the *IPv6 for Cisco IOS Command Reference*.

Configuration Examples for Implementing OSPF for IPv6

This section provides the following configuration examples:

- [Enabling OSPF for IPv6 on an Interface Configuration: Example, page 436](#)
- [Defining an OSPF for IPv6 Area Range: Example, page 436](#)
- [Defining Authentication on an Interface: Example, page 437](#)
- [Defining Authentication in an OSPF Area: Example, page 437](#)
- [Configuring NBMA Interfaces Configuration: Example, page 437](#)
- [Forcing SPF Configuration: Example, page 437](#)

Enabling OSPF for IPv6 on an Interface Configuration: Example

The following example configures an OSPF routing process 109 to run on the interface and puts it in area 1:

```
ipv6 ospf 109 area 1
```

Defining an OSPF for IPv6 Area Range: Example

The following example specifies an OSPF for IPv6 area range:

```

interface Ethernet7/0
  ipv6 address 2001:0DB8:0:0:7::/64 eui-64
  ipv6 enable
  ipv6 ospf 1 area 1
!
interface Ethernet8/0

```

```

ipv6 address 2001:0DB8:0:0:8::/64 eui-64
ipv6 enable
ipv6 ospf 1 area 1
!
interface Ethernet9/0
  ipv6 address 2001:0DB8:0:0:9::/64 eui-64
  ipv6 enable
  ipv6 ospf 1 area 1
!
ipv6 router ospf 1
  router-id 10.11.11.1
  area 1 range 2001:0DB8::/48

```

Defining Authentication on an Interface: Example

The following example defines authentication on the Ethernet 0/0 interface:

```

interface Ethernet0/0
  ipv6 enable
  ipv6 ospf 1 area 0
  ipv6 ospf authentication ipsec spi 500 md5 1234567890ABCDEF1234567890ABCDEF

interface Ethernet0/0
  ipv6 enable
  ipv6 ospf authentication null
  ipv6 ospf 1 area 0

```

Defining Authentication in an OSPF Area: Example

The following example defines authentication on OSPF area 0:

```

ipv6 router ospf 1
  router-id 11.11.11.1
  area 0 authentication ipsec spi 1000 md5 1234567890ABCDEF1234567890ABCDEF

```

Configuring NBMA Interfaces Configuration: Example

The following example configures an OSPF neighboring router with the IPv6 address of FE80::A8BB:CCFF:FE00:C01.

```

interface serial 0
  ipv6 enable
  ipv6 ospf 1 area 0
  encapsulation frame-relay
  frame-relay map ipv6 FE80::A8BB:CCFF:FE00:C01 120
  ipv6 ospf neighbor FE80::A8BB:CCFF:FE00:C0

```

Forcing SPF Configuration: Example

The following example triggers SPF to redo the SPF and repopulate the routing tables:

```

clear ipv6 ospf force-spf

```

Additional References

The following sections provide additional references related to the *Implementing OSPF for IPv6* module.

Related Documents

Related Topic	Document Title
OSPF for IPv4 tasks	“Configuring OSPF” chapter of the <i>Cisco IOS IP Configuration Guide</i> , Release 12.4
OSPF for IPv4 commands	<i>Cisco IOS IP Command Reference, Volume 2 of 4: Routing Protocols</i> , Release 12.4
Configuring a router ID in OSPF	“Configuring OSPF” chapter of the <i>Cisco IOS IP Configuration Guide</i> <i>Cisco IOS IP Command Reference, Volume 2 of 4: Routing Protocols</i> , Release 12.4
OSPF for IPv6 commands	<i>IPv6 for Cisco IOS Command Reference</i>
IPv6 supported feature list	<i>Start Here: Cisco IOS Software Release Specifics for IPv6 Features</i>
Getting IPv6 started	<i>Implementing Basic Connectivity for IPv6</i>
IPSec for IPv6	<i>Implementing IPSec for IPv6 Security</i>
Security configuration tasks (IPv4)	<i>Cisco IOS Security Configuration Guide</i>
Security commands: complete command syntax, command mode, defaults, usage guidelines, and examples (IPv4)	<i>Cisco IOS Security Command Reference</i>
IPv4 configuration and command reference information	<i>Cisco IOS Release 12.4 Configuration Guides and Command References</i>

Standards

Standards	Title
draft-ietf-ospf-ospfv3-auth-08.txt	<i>Authentication/Confidentiality for OSPFv3</i> , February 2006

MIBs

MIBs	MIBs Link
<ul style="list-style-type: none"> CISCO-IETF-IP-FORWARD-MIB CISCO-IETF-IP-MIB 	To locate and download MIBs for selected platforms, Cisco IOS releases, and feature sets, use Cisco MIB Locator found at the following URL: http://www.cisco.com/go/mibs

RFCs

RFCs	Title
RFC 2401	<i>Security Architecture for the Internet Protocol</i>
RFC 2402	<i>IP Authentication Header</i>
RFC 2406	<i>IP Encapsulating Security Payload (ESP)</i>
RFC 2740	<i>OSPF for IPv6</i>

Technical Assistance

Description	Link
The Cisco Technical Support website contains thousands of pages of searchable technical content, including links to products, technologies, solutions, technical tips, and tools. Registered Cisco.com users can log in from this page to access even more content.	http://www.cisco.com/techsupport



Implementing Policy-Based Routing for IPv6

Policy-based routing (PBR) for both IPv6 and IPv4 in Cisco IOS software allows a user to manually configure how received packets should be routed. PBR allows the user to identify packets using several attributes and to specify the next hop or output interface to which the packet should be sent. PBR also provides a basic packet-marking capability.

Finding Support Information for Platforms and Cisco IOS Software Images

Use Cisco Feature Navigator to find information about platform support and Cisco IOS software image support. Access Cisco Feature Navigator at <http://www.cisco.com/go/fn>. You must have an account on Cisco.com. If you do not have an account or have forgotten your username or password, click **Cancel** at the login dialog box and follow the instructions that appear.

Contents

- [Prerequisites for Policy-Based Routing for IPv6, page 441](#)
- [Restrictions for Policy-Based Routing for IPv6, page 442](#)
- [Information About Policy-Based Routing, page 442](#)
- [How to Implement Policy-Based Routing for IPv6, page 444](#)
- [Configuration Examples for Policy-Based Routing for IPv6, page 449](#)
- [Additional References, page 450](#)

Prerequisites for Policy-Based Routing for IPv6

- This module assumes that you are familiar with IPv6 addressing and basic configuration. Refer to the *Implementing Basic Connectivity for IPv6* module for more information.
- This module assumes that you are familiar with IPv4. Refer to the publications referenced in the “[Related Documents](#)” section for IPv4 configuration and command reference information, as needed.

Restrictions for Policy-Based Routing for IPv6

Distributed Cisco Express Forwarding (formerly known as dCEF) is supported on the Cisco 7500 series routers only.

Table 25 identifies the earliest release for each early-deployment release in which the feature became available.

Table 25 Minimum Required Cisco IOS Release

Feature	Minimum Required Cisco IOS Release by Release
Policy-Based Routing for IPv6	12.3(7)T, 12.4, 12.4(2)T, 12.2(30)S

Information About Policy-Based Routing

To configure PBR for IPv6 for Cisco IOS software, you must understand the following concepts:

- [Policy-Based Routing Overview, page 442](#)
- [How Policy-Based Routing Works, page 443](#)
- [When to Use Policy-Based Routing, page 444](#)

Policy-Based Routing Overview

PBR gives you a flexible means of routing packets by allowing you to configure a defined policy for traffic flows, which lessens reliance on routes derived from routing protocols. To this end, PBR gives you more control over routing by extending and complementing the existing mechanisms provided by routing protocols. PBR allows you to set the IPv6 precedence. It also allows you to specify a path for certain traffic, such as priority traffic over a high-cost link.

PBR for IPv6 may be applied to both forwarded and originated IPv6 packets. For forwarded packets, PBR for IPv6 will be implemented as an IPv6 input interface feature, supported in the process, Cisco Express Forwarding (formerly known as CEF), and distributed Cisco Express Forwarding forwarding paths.

You can set up PBR as a way to route packets based on configured policies. For example, you can implement routing policies to allow or deny paths based on the identity of a particular end system, an application protocol, or the size of packets.

PBR allows you to perform the following tasks:

- Classify traffic based on extended access list criteria. Access lists, then, establish the match criteria.
- Set IPv6 precedence bits, giving the network the ability to enable differentiated classes of service.
- Route packets to specific traffic-engineered paths; you might need to route them to allow a specific quality of service (QoS) through the network.

Policies can be based on IPv6 address, port numbers, protocols, or size of packets. For a simple policy, you can use any one of these descriptors; for a complex policy, you can use all of them.

PBR allows you to classify and mark packets at the edge of the network. PBR marks a packet by setting its precedence value. The precedence value can be used directly by routers in the network core to apply the appropriate QoS to a packet, which keeps packet classification at your network edge.

How Policy-Based Routing Works

All packets received on an interface with PBR enabled are passed through enhanced packet filters known as route maps. The route maps used by PBR dictate the policy, determining where to forward packets.

Route maps are composed of statements. The route map statements can be marked as permit or deny, and they are interpreted in the following ways:

- If a packet matches all match statements for a route map that is marked as permit, then the router attempts to policy route the packet using the set statements. Otherwise, the packet is forwarded normally.
- If the packet matches any match statements for a route map that is marked as deny, then the packet is not subject to PBR and is forwarded normally.
- If the statement is marked as permit and the packets do not match any route map statements, the packets are sent back through the normal forwarding channels and destination-based routing is performed.

You specify PBR on the interface that receives the packet, not on the interface from which the packet is sent.

Packet Matching

PBR for IPv6 will match packets using the **match ipv6 address** command in the associated PBR route map. Packet match criteria are those criteria supported by IPv6 access lists, as follows:

- Input interface
- Source IPv6 address (using a prefix list or a standard or extended access list [ACL])
- Destination IPv6 address (standard or extended ACL)
- Protocol (extended ACL)
- Source port and destination port (extended ACL)
- Differentiated services code point (DSCP) (extended ACL)
- Flow-label (extended ACL)
- Fragment (extended ACL)

Packets may also be matched by length using the match length statement in the PBR route map.

Match statements are evaluated first by the criteria specified in the **match ipv6 address** command and then by criteria specified in the **match length** command. Therefore, if both an ACL and a length statement are used, a packet will first be subject to an ACL match. Only packets that pass the ACL match will then be subject to the length match. Finally, only packets that pass both the ACL and the length statement will be policy routed.

Packet Forwarding Using Set Statements

PBR for IPv6 packet forwarding is controlled using a number of set statements in the PBR route map. These set statements are evaluated individually in the order shown, and PBR will attempt to forward the packet using each of the of the set statements in turn. PBR evaluates each set statement by itself, without reference to any prior or subsequent set statement.

You may set multiple forwarding statements in the PBR for IPv6 route map. The following set statements may be specified:

- IPv6 next hop. The next hop to which the packet should be sent. The next hop must be present in the Routing Information Base (RIB), it must be directly connected, and it must be a global IPv6 address. If the next hop is invalid, the set statement is ignored.
- Output interface. A packet is forwarded out of a specified interface. An entry for the packet destination address must exist in the IPv6 RIB, and the specified output interface must be in the path set. If the interface is invalid, the statement is ignored.
- Default IPv6 next hop. The next hop to which the packet should be sent. It must be a global IPv6 address. This set statement is used only when there is no explicit entry for the packet destination in the IPv6 RIB.
- Default output interface. The packet is forwarded out a specified interface. This set statement is used only when there is no explicit entry for the packet destination in the IPv6 RIB.

**Note**

The order in which PBR evaluates the set statements is the order in which they are listed above. This order may differ from the order in which route-map set statements are listed by Cisco IOS **show** commands.

When to Use Policy-Based Routing

You might use PBR if you want certain packets to be routed some way other than the obvious shortest path. For example, PBR can be used to provide the following functionality:

- Equal access
- Protocol-sensitive routing
- Source-sensitive routing
- Routing based on interactive versus batch traffic
- Routing based on dedicated links

Some applications or traffic can benefit from QoS-specific routing; for example, you could transfer stock records to a corporate office on a higher-bandwidth, higher-cost link for a short time while sending routine application data such as e-mail over a lower-bandwidth, lower-cost link.

How to Implement Policy-Based Routing for IPv6

The tasks in the following sections explain how to implement Policy-Based Routing for IPv6:

- [Enabling PBR on an Interface, page 444](#)
- [Enabling Local PBR for IPv6, page 447](#)
- [Enabling Cisco Express Forwarding-Switched PBR for IPv6, page 447](#)
- [Troubleshooting PBR for IPv6, page 448](#)

Enabling PBR on an Interface

To enable PBR for IPv6, you must create a route map that specifies the packet match criteria and desired policy-route action. Then you associate the route map on the required interface. All packets arriving on the specified interface that match the match clauses will be subject to PBR.

This task enables PBR on an interface.

SUMMARY STEPS

1. **enable**
2. **configure terminal**
3. **route-map** *map-tag* [**permit** | **deny**] [*sequence-number*]
4. **match length** *minimum-length maximum-length*
or
match ipv6 address {**prefix-list** *prefix-list-name* | *access-list-name*}
5. **set ipv6 precedence** *precedence-value*
or
set ipv6 next-hop *global-ipv6-address* [*global-ipv6-address...*]
or
set interface *type number* [...*type number*]
or
set ipv6 default next-hop *global-ipv6-address* [*global-ipv6-address...*]
or
set default interface *type number* [...*type number*]
6. **exit**
7. **interface** *type number*
8. **ipv6 policy route-map** *route-map-name*

DETAILED STEPS

	Command or Action	Purpose
Step 1	enable Example: Router> enable	Enables privileged EXEC mode. <ul style="list-style-type: none"> Enter your password if prompted.
Step 2	configure terminal Example: Router# configure terminal	Enters global configuration mode.
Step 3	route-map <i>map-tag</i> [permit deny] [<i>sequence-number</i>] Example: Router(config)# route-map rip-to-ospf permit	Defines the conditions for redistributing routes from one routing protocol into another, or enables policy routing. <ul style="list-style-type: none"> Use the route-map command to enter route-map configuration mode.

	Command or Action	Purpose
Step 4	<pre>match length minimum-length maximum-length or match ipv6 address {prefix-list prefix-list-name access-list-name} Example: Router(config-route-map)# match length 3 200 or Router(config-route-map)# match ipv6 address marketing</pre>	<p>Specifies the match criteria.</p> <ul style="list-style-type: none"> You can specify any or all of the following: <ul style="list-style-type: none"> Matches the Level 3 length of the packet. Matches a specified IPv6 access list. If you do not specify a match command, the route map applies to all packets.
Step 5	<pre>set ipv6 precedence precedence-value or set ipv6 next-hop global-ipv6-address [global-ipv6-address...] or set interface type number [...type number] or set ipv6 default next-hop global-ipv6-address [global-ipv6-address...] or set default interface type number [...type number] Example: Router(config-route-map)# set ipv6 precedence 1 or Router(config-route-map)# set ipv6 next-hop 2001:0db8:2003:1::95 or Router(config-route-map)# set interface ethernet 0 or Router(config-route-map)# set ipv6 default next-hop 2001:0db8:2003:1::95 or Router(config-route-map)# set default interface ethernet 0</pre>	<p>Specifies the action or actions to take on the packets that match the criteria.</p> <ul style="list-style-type: none"> You can specify any or all of the following: <ul style="list-style-type: none"> Sets precedence value in the IPv6 header. Sets next hop to which to route the packet (the next hop must be adjacent). Sets output interface for the packet. Sets next hop to which to route the packet, if there is no explicit route for this destination. Sets output interface for the packet, if there is no explicit route for this destination.
Step 6	<pre>exit Example: Router(config-route-map)# exit</pre>	<p>Returns the router to global configuration mode.</p>

	Command or Action	Purpose
Step 7	interface <i>type number</i> Example: Router(config)# interface FastEthernet 1/0	Specifies an interface type and number, and places the router in interface configuration mode.
Step 8	ipv6 policy route-map <i>route-map-name</i> Example: Router(config-if)# ipv6 policy-route-map interactive	Identifies a route map to use for IPv6 PBR on an interface.

Enabling Local PBR for IPv6

Packets that are generated by the router are not normally policy routed. This task enables local PBR for IPv6 for such packets, indicating which route map the router should use.

SUMMARY STEPS

1. **enable**
2. **configure terminal**
3. **ipv6 local policy route-map** *route-map-name*

DETAILED STEPS

	Command or Action	Purpose
Step 1	enable Example: Router> enable	Enables privileged EXEC mode. <ul style="list-style-type: none"> • Enter your password if prompted.
Step 2	configure terminal Example: Router# configure terminal	Enters global configuration mode.
Step 3	ipv6 local policy route-map <i>route-map-name</i> Example: Router(config)# ipv6 local policy route-map pbr-src-90	Configures PBR for IPv6 for packets generated by the router.

Enabling Cisco Express Forwarding-Switched PBR for IPv6

Beginning in Cisco IOS Release 12.3(7)T, PBR for IPv6 is supported in the Cisco Express Forwarding switching path. Cisco Express Forwarding-switched PBR is the optimal way to perform PBR on a router.

No special configuration is required to enable Cisco Express Forwarding-switched PBR for IPv6. It is on by default as soon as you enable Cisco Express Forwarding and PBR on the router.

Verifying Configuration and Operation of PBR for IPv6

This task explains how to display information to verify the configuration and operation of PBR for IPv6.

SUMMARY STEPS

1. `enable`
2. `show ipv6 policy`

DETAILED STEPS

	Command or Action	Purpose
Step 1	<code>enable</code> Example: <code>Router> enable</code>	Enables privileged EXEC mode. <ul style="list-style-type: none"> • Enter your password if prompted.
Step 2	<code>show ipv6 policy</code> Example: <code>Router# show ipv6 policy</code>	Displays IPv6 policy routing packet activity.

Troubleshooting PBR for IPv6

Policy routing looks at various parts of the packet and then routes the packet based on certain user-defined attributes in the packet. This task helps you determine what policy routing is following, whether a packet matches the criteria, and if so, the resulting routing information for the packet.

SUMMARY STEPS

1. `enable`
2. `debug ipv6 policy [access-list-name]`
3. `show route-map [map-name | dynamic [dynamic-map-name | application [application-name]] | all] [detailed]`

DETAILED STEPS

	Command or Action	Purpose
Step 1	enable Example: Router> enable	Enables privileged EXEC mode. <ul style="list-style-type: none"> Enter your password if prompted.
Step 2	debug ipv6 policy [<i>access-list-name</i>] Example: Router# debug ipv6 policy	Displays IPv6 policy routing packet activity.
Step 3	show route-map [<i>map-name</i> dynamic [<i>dynamic-map-name</i> application [<i>application-name</i>]] all] [detailed] Example: Router# show route-map	Displays all route maps configured or only the one specified.

Examples

This section provides the following output examples:

- [Sample Output for the show ipv6 policy Command, page 449](#)
- [Sample Output for the show route-map Command, page 449](#)

Sample Output for the show ipv6 policy Command

The **show ipv6 policy** command displays PBR configuration, as shown in the following example:

```
Router# show ipv6 policy

Interface          Routemap
Ethernet0/0        src-1
```

Sample Output for the show route-map Command

The **show route-map** command displays specific route-map information, such as a count of policy matches:

```
Router# show route-map

route-map bill, permit, sequence 10
  Match clauses:
  Set clauses:
  Policy routing matches:0 packets, 0 bytes
```

Configuration Examples for Policy-Based Routing for IPv6

The following sections provide PBR for IPv6 configuration examples:

- [Enabling PBR on an Interface: Example, page 450](#)
- [Enabling Local PBR for IPv6: Example, page 450](#)

Enabling PBR on an Interface: Example

In the following example, a route map named pbr-dest-1 is created and configured, specifying packet match criteria and desired policy-route action. Then, PBR is enabled on Ethernet interface 0/0.

```
ipv6 access-list match-dest-1
  permit ipv6 any 2001:0db8:2001:1760::/32

route-map pbr-dest-1 permit 10
  match ipv6 address match-dest-1
  set interface Ethernet 0/0

interface Ethernet0/0
  ipv6 policy-route-map interactive
```

Enabling Local PBR for IPv6: Example

In the following example, packets with a destination IPv6 address matching that allowed by access list pbr-src-90 are sent to the router at IPv6 address 2001:0db8:2003:1::95:

```
ipv6 access-list src-90
  permit ipv6 host 2001:0db8:2003::90 2001:0db8:2001:1000::/64

route-map pbr-src-90 permit 10
  match ipv6 address src-90
  set ipv6 next-hop 2001:0db8:2003:1::95

ipv6 local policy route-map pbr-src-90
```

Additional References

The following sections provide references related to implementing PBR for IPv6.

Related Documents

Related Topic	Document Title
QoS for IPv6	<i>Implementing QoS for IPv6</i>
Multicast Border Gateway Protocol (BGP) for IPv6	<i>Implementing Multiprotocol BGP for IPv6</i>
Access control lists for IPv6	<i>Implementing Traffic Filters and Firewalls for IPv6 Security</i>
IPv6 supported feature list	<i>Start Here: Cisco IOS Software Release Specifics for IPv6 Features</i>
IPv6 commands: complete command syntax, command mode, defaults, usage guidelines, and examples	<i>IPv6 for Cisco IOS Command Reference</i>
IPv4 Policy-Based Routing	<i>Cisco IOS Quality of Service Solutions Configuration Guide</i>
IPv4 configuration and command reference information	Cisco IOS Release 12.4 Configuration Guides and Command References

MIBs

MIBs	MIBs Link
No new or modified MIBs are required for this feature.	To locate and download MIBs for selected platforms, Cisco IOS releases, and feature sets, use Cisco MIB Locator found at the following URL: http://www.cisco.com/go/mibs

Technical Assistance

Description	Link
The Cisco Technical Support website contains thousands of pages of searchable technical content, including links to products, technologies, solutions, technical tips, and tools. Registered Cisco.com users can log in from this page to access even more content.	http://www.cisco.com/techsupport

■ Additional References



Implementing QoS for IPv6 for Cisco IOS Software

This module provides tasks for implementing quality of service (QoS) features in IPv6 environments, specifically the application of the Differentiated Services (DiffServ) QoS features to IPv6 packets.

Finding Support Information for Platforms and Cisco IOS Software Images

Use Cisco Feature Navigator to find information about platform support and Cisco IOS software image support. Access Cisco Feature Navigator at <http://www.cisco.com/go/fn>. You must have an account on Cisco.com. If you do not have an account or have forgotten your username or password, click **Cancel** at the login dialog box and follow the instructions that appear.

Contents

- [Prerequisites for QoS for IPv6, page 453](#)
- [Restrictions for QoS for IPv6, page 454](#)
- [Information About QoS in IPv6, page 454](#)
- [How to Implement QoS for IPv6, page 457](#)
- [Configuration Examples for Implementing QoS for IPv6, page 467](#)
- [Additional References, page 468](#)

Prerequisites for QoS for IPv6

[Table 26](#) identifies the earliest release for each early-deployment train in which the feature became available.

Table 26 Minimum Required Cisco IOS Release

Feature	Minimum Required Cisco IOS Release by Release Train
IPv6 quality of service (QoS)	12.2(13)T, 12.3, 12.3(2)T, 12.0(28)S ¹ , 12.4, 12.4(2)T, 12.2(33)SRA
Modular QoS command-line interface (MQC) packet classification	12.2(13)T, 12.3, 12.3(2)T, 12.4, 12.4(2)T, 12.2(33)SRA

Table 26 Minimum Required Cisco IOS Release

Feature	Minimum Required Cisco IOS Release by Release Train
MQC traffic shaping	12.2(13)T, 12.3, 12.3(2)T, 12.0(28)S ¹ , 12.4, 12.4(2)T, 12.2(33)SRA
MQC traffic policing	12.2(13)T, 12.3, 12.3(2)T, 12.0(28)S ¹ , 12.4, 12.4(2)T, 12.2(33)SRA
MQC packet marking/remarking	12.2(13)T, 12.3, 12.3(2)T, 12.0(28)S ¹ , 12.4, 12.4(2)T, 12.2(33)SRA
Queueing	12.2(13)T, 12.3, 12.3(2)T, 12.0(28)S ¹ , 12.4, 12.4(2)T, 12.2(33)SRA
MQC WRED-based drop	12.2(13)T, 12.3, 12.3(2)T, 12.0(28)S ¹ , 12.4, 12.4(2)T, 12.2(33)SRA

1. Feature is supported on Cisco 12000 series Internet routers in Cisco IOS Release 12.0(28)S.

Restrictions for QoS for IPv6

The following QoS features are not supported for managing IPv6 traffic:

- Compressed Real-Time Protocol (CRTP)
- Network-based application recognition (NBAR)
- Committed access rate (CAR)
- Priority queueing (PQ)
- Custom queueing (CQ)

Platform-Specific Information and Restrictions

IPv6 QoS is supported on Cisco 12000 series Internet routers in Cisco IOS Release 12.0(28)S. Certain features of IPv6 QoS are not supported in Release 12.0(28)S. These features include packet classification.

Information About QoS in IPv6

The following sections provide information about the QoS features available for managing IPv6 traffic:

- [Implementation Strategy for QoS for IPv6, page 455](#)
- [Packet Classification in IPv6, page 455](#)
- [Policies and Class-Based Packet Marking in IPv6 Networks, page 456](#)
- [Congestion Management in IPv6 Networks, page 456](#)
- [Congestion Avoidance for IPv6 Traffic, page 456](#)
- [Traffic Policing in IPv6 Environments, page 456](#)

Implementation Strategy for QoS for IPv6

IPv6 packets are forwarded by paths that are different from those for IPv4. QoS features supported for IPv6 environments include packet classification, queueing, traffic shaping, WRED, class-based packet marking, and policing of IPv6 packets. These features are available at both the process switching and Cisco Express Forwarding (CEF) switching paths of IPv6.

All of the QoS features available for IPv6 environments are managed from the modular QoS command-line interface (CLI). The modular QoS CLI allows you to define traffic classes, create and configure traffic policies (policy maps), and then attach those traffic policies to interfaces. A detailed description of the modular QoS CLI can be found in the *Cisco IOS Quality of Service Configuration Guide*.

To implement QoS in networks running IPv6, follow the same steps that you would follow to implement QoS in networks running only IPv4. At a very high level, the basic steps for implementing QoS are as follows:

1. Know which applications in your network need QoS.
2. Understand the characteristics of the applications so that you can make decisions about which QoS features would be appropriate.
3. Know your network topology so that you know how link layer header sizes are affected by changes and forwarding.
4. Create classes based on the criteria you establish for your network. In particular, if the same network is also carrying IPv4 traffic along with IPv6, decide if you want to treat both of them the same way or treat them separately and specify match criteria accordingly. If you want to treat them the same, use match statements such as **match precedence**, **match dscp**, **set precedence**, and **set dscp**. If you want to treat them separately, add match criteria such as **match protocol ip** and **match protocol ipv6** in a match-all class map.
5. Create a policy to mark each class.
6. Work from the edge toward the core in applying QoS features.
7. Build the policy to treat the traffic.
8. Apply the policy.

Packet Classification in IPv6

Packet classification is available with both process and CEF switching path. Classification can be based on IPv6 precedence, differentiated services control point (DSCP), and other IPv6 protocol-specific values that can be specified in IPv6 access lists in addition to other non-IPv6 protocol specific values such as COS, packet length, and QOS group. Once you determine which applications need QoS, you can create classes based on the characteristics of the applications. You can use a variety of match criteria to classify traffic. You can combine various match criteria to segregate, isolate, and differentiate traffic.

The enhancements to the modular QoS CLI allow you to create matches on precedence, DSCP, and IPv6 access group values in both IPv4 and IPv6 packets. The **match** command has been modified so that matches can be made on DSCP values and precedence for both IP and IPv6 packets. See [“Using the](#)

[Match Criteria to Manage IPv6 Traffic Flows” section on page 162](#) for configuration guidelines and see the **match dscp** and **match precedence** command descriptions. See the “Enhanced Packet Marking” document in Release 12.2(13)T for details of the modular QoS CLI enhancements.

Policies and Class-Based Packet Marking in IPv6 Networks

You can create a policy to mark each class of traffic with appropriate priority values, using either DSCP or precedence. Class-based marking allows you to set the IPv6 precedence and DSCP values for traffic management. The traffic is marked as it enters the router on the ingress interface. The markings are used to treat the traffic (forward, queue) as it leaves the router on the egress interface. Always mark and treat the traffic as close as possible to its source.

Use the **set dscp** and **set precedence** commands for packet marking. These commands have been modified to handle both IPv4 and IPv6 traffic. See the [“Specifying Marking Criteria for IPv6 Packets” section on page 457](#) for configuration guidelines for using these commands. See the **set dscp** and **set precedence** command pages for detailed descriptions of the commands.

Congestion Management in IPv6 Networks

Once you have marked the traffic, you can use the markings to build a policy and classify traffic on the rest of the network segments. If you keep the policy simple (no more than about four classes), it will be easier to manage. Class-based and flow-based queueing are supported for IPv6. The processes and tasks use the same commands and arguments to configure various queueing options for both IP and IPv6. Refer to the *Cisco IOS Quality of Service Configuration Guide* for configuration and usage instructions of queueing features.

Congestion Avoidance for IPv6 Traffic

WRED implements the RED-based drop policy on the packets that are likely to overflow the limits of Class-based Weighted Fair Queueing (CBWFQ). WRED supports class-based and flow-based (using DSCP or precedence values) queueing. The WRED commands apply to both IPv4 and IPv6 with no changes. Refer to the *Cisco IOS Quality of Service Solutions Configuration Guide* for information about these QoS features.

Traffic Policing in IPv6 Environments

Congestion management for IPv6 is similar to its implementation for IP packets, and the commands used to configure queueing and traffic shaping features for IPv6 environments are the same commands as those used for IP. Traffic shaping allows you to limit the packet dequeue rate by holding additional packets in the queues and forwarding them as specified by parameters configured for traffic shaping features. Traffic shaping uses flow-based queueing by default. CBWFQ can be used to classify and prioritize the packets. Class-Based Policer and Generic Traffic Shaping (GTS) or Frame Relay Traffic Shaping (FRTS) can be used for conditioning and policing traffic.

Although no changes to existing configuration or command usage for policing are required for use in IPv6 environments, the **police** command has been enhanced to mark both IPv4 and IPv6 packets when the following keyword options are used in confirm action, exceed action, and violate action:

- **set-dscp-transmit**

- **set-precedence-transmit**

Refer to the *Cisco IOS Quality of Service Solutions Configuration Guide* for information about these features and *Cisco IOS Quality of Service Solutions Command Reference* for detailed descriptions of these commands and their options.

How to Implement QoS for IPv6

These configuration tasks describe how to classify traffic with match criteria and use the match criteria to manage traffic flows. The following sections are included:

- [Restrictions for Classifying Traffic in IPv6 Networks, page 457](#) (required)
- [Specifying Marking Criteria for IPv6 Packets, page 457](#) (required)
- [Using the Match Criteria to Manage IPv6 Traffic Flows, page 458](#) (required)
- [Verifying Packet Marking Criteria, page 460](#) (optional)

Restrictions for Classifying Traffic in IPv6 Networks

Except for the modifications to the **match dscp** and **match precedence** commands (which are described in this document) and the addition of the IPv6-specific **match access-group name** command, the functionality of all of the **match** commands is the same for both IPv4 and IPv6.

The **match access-group xxx** command for matching numbered access lists is not supported. Note that the **match ip rtp** command for matching RTP port ranges works only for IPv4 packets.

The **set cos** and **match cos** commands for 802.1Q (dot1Q) interfaces are supported only for CEF-switched packets. Process-switched packets, such as router-generated packets, are not marked when these options are used.

The **set cos** and **match cos** for ISL links is not supported for CEF-switched packets. Process switching is not supported with these options.

Specifying Marking Criteria for IPv6 Packets

The following task uses the **set precedence** command to establish the match criteria (or mark the packets) that will be used later to match packets for classifying network traffic. Commands used for this purpose are **set precedence** and **set dscp**. These commands have been modified to accommodate marking of IPv6 packets.

SUMMARY STEPS

1. **enable**
 2. **configure terminal**
 3. **policy map** *policy-map-name*
 4. **class** { *class-name* | **class-default** }
 5. **set precedence** { *precedence-value* | *from-field* [**table** *table-map-name*] }
- or
- set [ip] dscp** { *dscp-value* | *from-field* [**table** *table-map-name*] }

DETAILED STEPS

	Command or Action	Purpose
Step 1	enable Example: Router> enable	Enables such as privileged EXEC mode. <ul style="list-style-type: none"> Enter your password if prompted.
Step 2	configure terminal Example: Router# configure terminal	Enters global configuration mode.
Step 3	policy map <i>policy-map-name</i> Example: Router(config)# policy map policy1	Creates a policy map using the specified name and enters QoS policy-map configuration mode. <ul style="list-style-type: none"> Enter name of policy map you want to create.
Step 4	class { <i>class-name</i> class-default } Example: Router(config-pmap)# class class-default	Specifies the treatment for traffic of specified class (or the default class) and enters QoS policy-map class configuration mode.
Step 5	set precedence { <i>precedence-value</i> <i>from-field</i> [table <i>table-map-name</i>]} or set [ip] dscp { <i>dscp-value</i> <i>from-field</i> [table <i>table-map-name</i>]} Example: Router(config-pmap-c)# set dscp cos table table-map1 Router(config-pmap-c)# set precedence cos table table-map1	Sets the precedence value. This example is based on the CoS value (and action) defined in the specified table map. The CLI is applicable to both IPv4 and IPv6 packets. However, the action occurs only on the packets that matched the criteria specified for the class name used in Step 4. <ul style="list-style-type: none"> Both precedence and DSCP cannot be changed in the same packets. Sets the DSCP value based on the CoS value (and action) defined in the specified table map.

Troubleshooting Tips

Confirm That CEF Is Enabled

Use the **show cef interface**, **show ipv6 cef**, **show ipv6 interface neighbors**, and **show interface statistics** commands to confirm that CEF is enabled and that packets are being CEF switched.

Confirm That Packets Are CEF Switched

Use the **show policy-map interface** command to display per-interface, per-policy CEF-switching statistics.

Using the Match Criteria to Manage IPv6 Traffic Flows

Once you have defined the traffic classes and established the policies, you can use the **match** commands to match the traffic to the policies that you establish. You can use multiple match statements. Depending on the type of class, you can specify whether to match all classes or any of the classes.

SUMMARY STEPS

1. **enable**
2. **configure terminal**
3. **class-map** {*class-name* | **class-default**}
4. **match precedence** *precedence-value* [*precedence-value precedence-value*]
 or
match access-group name *ipv6-access-group*
 or
match [ip] dscp *dscp-value* [*dscp-value dscp-value dscp-value dscp-value dscp-value dscp-value dscp-value*]

DETAILED STEPS

	Command or Action	Purpose
Step 1	enable Example: Router> enable	Enables such as privileged EXEC mode. <ul style="list-style-type: none"> • Enter your password if prompted.
Step 2	configure terminal Example: Router# configure terminal	Enters global configuration mode.
Step 3	class-map { <i>class-name</i> class-default } Example: Router(config-pmap-c)# class cls1	Creates the specified class and enters QoS class-map configuration mode.
Step 4	match precedence <i>precedence-value</i> [<i>precedence-value precedence-value</i>] or match access-group name <i>ipv6-access-group</i> or match [ip] dscp <i>dscp-value</i> [<i>dscp-value dscp-value dscp-value dscp-value dscp-value dscp-value dscp-value</i>] Example: Router(config-pmap-c)# match precedence 5 Router(config-pmap-c)# match access-group name ipv6acl Router(config-pmap-c)# match ip dscp 15	Matches the precedence value. The precedence applies to both IPv4 and IPv6 packets. or Specifies the name of an IPv6 access list against whose contents packets are checked to determine if they belong to the traffic class. or Identifies a specific IP DSCP value as a match criterion.

Configuration Examples for Using the Match Criteria to Manage IPv6 Traffic Flows

The following example shows how to use the **match precedence** command to manage IPv6 traffic flows.

```
Router# configure terminal

Enter configuration commands, one per line. End with CNTL/Z.
Router(config)# class-map c1
Router(config-cmap)# match precedence 5
Router(config-cmap)# end
Router#
Router(config)# policy-map p1
Router(config-pmap)# class c1
Router(config-pmap-c)# police 10000 conform set-prec-trans 4
Router(config-pmap-c)# end
Router#
```

Verifying Packet Marking Criteria

To verify that packet marking is working as expected, use the **show policy** command. The interesting information from the output of this command is the difference in the number of total packets versus the number of packets marked. Explanations of the counters follow the example.

```
Router# show policy p1

Policy Map p1
  Class c1
    police 10000 1500 1500 conform-action set-prec-transmit 4 exceed-action drop

Router# configure terminal
Enter configuration commands, one per line. End with CNTL/Z.
Router(config)# interface serial 4/1
Router(config-if)# service-out p1
Router(config-if)# end
Router#
Router# show policy interface s4/1
Serial4/1
Service-policy output: p1
Class-map: c1 (match-all)
  0 packets, 0 bytes
  5 minute offered rate 0 bps, drop rate 0 bps
Match: precedence 5
police:
  10000 bps, 1500 limit, 1500 extended limit
  conformed 0 packets, 0 bytes; action: set-prec-transmit 4
  exceeded 0 packets, 0 bytes; action: drop
  conformed 0 bps, exceed 0 bps violate 0 bps

Class-map: class-default (match-any)
  10 packets, 1486 bytes
  5 minute offered rate 0 bps, drop rate 0 bps
Match: any
```

Interpreting Packet Counters in show policy-map interface Command Output

During periods of transmit congestion at the outgoing interface, packets arrive faster than the interface can send them. It is helpful to know how to interpret the output of the **show policy-map interface** command, which is useful for monitoring the results of a service-policy created with Cisco's modular QoS CLI.

Congestion typically occurs when a fast ingress interface feeds a relatively slow egress interface. A common congestion point is a branch-office router with an Ethernet port facing the LAN and a serial port facing the WAN. Users on the LAN segment are generating 10 Mbps of traffic, which is being fed into a T1 with 1.5 Mbps of bandwidth.

Functionally, congestion is defined as filling the transmit ring on the interface (a ring is a special buffer control structure). Every interface supports a pair of rings: a receive ring for receiving packets and a transmit ring for sending packets. The size of the rings varies with the interface controller and with the bandwidth of the interface or virtual circuit (VC). As in the following example, use the **show atm vc vcd** command to display the value of the transmit ring on a PA-A3 ATM port adapter.

```
Router# show atm vc 3

ATM5/0.2: VCD: 3, VPI: 2, VCI: 2
VBR-NRT, PeakRate: 30000, Average Rate: 20000, Burst Cells: 94
AAL5-LLC/SNAP, etype:0x0, Flags: 0x20, VCmode: 0x0
OAM frequency: 0 second(s)
PA TxRingLimit: 10
InARP frequency: 15 minutes(s)
Transmit priority 2
InPkts: 0, OutPkts: 0, InBytes: 0, OutBytes: 0
InPRoc: 0, OutPRoc: 0
InFast: 0, OutFast: 0, InAS: 0, OutAS: 0
InPktDrops: 0, OutPktDrops: 0
CrcErrors: 0, SarTimeOuts: 0, OverSizedSDUs: 0
OAM cells received: 0
OAM cells sent: 0
Status: UP
```

Cisco IOS software (also referred to as the Layer 3 processor) and the interface driver use the transmit ring when moving packets to the physical media. The two processors collaborate in the following way:

- The interface sends packets according to the interface rate or a shaped rate.
- The interface maintains a hardware queue or transmit ring, where it stores the packets waiting for transmission onto the physical wire.
- When the hardware queue or transmit ring fills, the interface provides explicit back pressure to the Layer 3 processor system. It notifies the Layer 3 processor to stop dequeuing packets to the interface's transmit ring because the transmit ring is full. The Layer 3 processor now stores the excess packets in the Layer 3 queues.
- When the interface sends the packets on the transmit ring and empties the ring, it once again has sufficient buffers available to store the packets. It releases the back pressure, and the Layer 3 processor dequeues new packets to the interface.

The most important aspect of this communication system is that the interface recognizes that its transmit ring is full and throttles the receipt of new packets from the Layer 3 processor system. Thus, when the interface is congested, the drop decision is moved from a random, last-in, first-dropped decision in the first in, first out (FIFO) queue of the transmit ring to a differentiated decision based on IP-level service policies implemented by the Layer 3 processor.

Number of Packets and Packets Matched

Service policies apply only to packets stored in the Layer 3 queues. [Table 27](#) illustrates which packets sit in the Layer 3 queue. Locally generated packets are always process switched and are delivered first to the Layer 3 queue before being passed on to the interface driver. Fast-switched and CEF-switched packets are delivered directly to the transmit ring and sit in the L3 queue only when the transmit ring is full.

Table 27 Packet Types and the Layer 3 Queue

Packet Type	Congestion	Noncongestion
Locally generated packets, including Telnet packets and pings	Yes	Yes
Other packets that are process switched	Yes	Yes
Packets that are CEF or fast switched	Yes	No

The following example shows these guidelines applied to the **show policy-map interface** command output. The four key counters are shown in boldface type.

```
Router# show policy-map interface atm 1/0.1

ATM1/0.1: VC 0/100 -
Service-policy output: cbwfg (1283)
Class-map: A (match-all) (1285/2)
  28621 packets, 7098008 bytes
  5 minute offered rate 10000 bps, drop rate 0 bps
  Match: access-group 101 (1289)
  Weighted Fair Queueing
    Output Queue: Conversation 73
    Bandwidth 500 (kbps) Max Threshold 64 (packets)
    (pkts matched/bytes matched) 28621/7098008
    (depth/total drops/no-buffer drops) 0/0/0
  Class-map: B (match-all) (1301/4)
    2058 packets, 148176 bytes
    5 minute offered rate 0 bps, drop rate 0 bps
    Match: access-group 103 (1305)
    Weighted Fair Queueing
      Output Queue: Conversation 75
      Bandwidth 50 (kbps) Max Threshold 64 (packets)
      (pkts matched/bytes matched) 0/0
      (depth/total drops/no-buffer drops) 0/0/0
  Class-map: class-default (match-any) (1309/0)
    19 packets, 968 bytes
    5 minute offered rate 0 bps, drop rate 0 bps
    Match: any (1313)
```

Table 28 defines the counters that appear in the example in boldfaced type.

Table 28 Packet Counters from show policy map interface Output

Counter	Explanation
28621 packets, 7098008 bytes	The number of packets matching the criteria of the class. This counter increments whether or not the interface is congested.
(pkts matched/bytes matched) 28621/709800	The number of packets matching the criteria of the class when the interface was congested. In other words, the interface's transmit ring was full, and the driver and the L3 processor system worked together to queue the excess packets in the L3 queues, where the service policy applies. Packets that are process switched always go through the L3 queuing system and therefore increment the "packets matched" counter.

Table 28 Packet Counters from `show policy map interface` Output

Counter	Explanation
Class-map: B (match-all) (1301/4)	These numbers define an internal ID used with the CISCO-CLASS-BASED-QOS-MIB Management Information Base (MIB). They no longer appear in the <code>show policy-map</code> command output in current releases of Cisco IOS.
5 minute offered rate 0 bps, drop rate 0 bps	Use the <code>load-interval</code> command to change this value and make it a more instantaneous value. The lowest value is 30 seconds; however, statistics displayed in the <code>show policy-map interface</code> command output are updated every 10 seconds. Because the command effectively provides a snapshot at a specific moment, the statistics may not reflect a temporary change in queue size.

Without congestion, there is no need to queue any excess packets. When congestion occurs, packets, including CEF- and fast-switched packets, might go into the Layer 3 queue. If you use congestion management features, packets accumulating at an interface are queued until the interface is free to send them; they are then scheduled according to their assigned priority and the queuing mechanism configured for the interface.

Normally, the packets counter is much larger than the packets matched counter. If the values of the two counters are nearly equal, then the interface is receiving a large number of process-switched packets or is heavily congested. Both of these conditions should be investigated to ensure optimal packet forwarding.

Conversation Number Allocation

Routers allocate conversation numbers for the queues that are created when the service policy is applied. The following example shows the queues and related information.

```
Router# show policy-map interface s1/0.1 d1ci 100

Serial1/0.1: DLCI 100 -
output : mypolicy
Class voice
  Weighted Fair Queueing
  Strict Priority
  Output Queue: Conversation 72
    Bandwidth 16 (Kbps) Packets Matched 0
    (pkts discards/bytes discards) 0/0
Class immediate-data
  Weighted Fair Queueing
  Output Queue: Conversation 73
    Bandwidth 60 (%) Packets Matched 0
    (pkts discards/bytes discards/tail drops) 0/0/0
    mean queue depth: 0
  drops: class  random  tail      min-th  max-th  mark-prob
         0      0      0        64     128    1/10
         1      0      0        71     128    1/10
         2      0      0        78     128    1/10
         3      0      0        85     128    1/10
         4      0      0        92     128    1/10
         5      0      0        99     128    1/10
         6      0      0       106     128    1/10
```

```

          7      0      0      113      128      1/10
          rsvp  0      0      120      128      1/10
Class priority-data
  Weighted Fair Queueing
    Output Queue: Conversation 74
      Bandwidth 40 (%) Packets Matched 0 Max Threshold 64 (packets)
      (pkts discards/bytes discards/tail drops) 0/0/0
Class class-default
  Weighted Fair Queueing
    Flow Based Fair Queueing
      Maximum Number of Hashed Queues 64 Max Threshold 20 (packets)

```

Information reported for each class includes the following:

- Class definition
- Queueing method applied
- Output Queue Conversation number
- Bandwidth used
- Number of packets discarded
- Number of bytes discarded
- Number of packets dropped

The **class-default** class is the default class to which traffic is directed, if that traffic does not satisfy the match criteria of other classes whose policy is defined in the policy map. The **fair-queue** command allows you to specify the number of dynamic queues into which IP flows are sorted and classified. Alternately, routers allocate a default number of queues derived from the bandwidth on the interface or VC. Supported values in either case are a power of two, in a range from 16 to 4096.

Table 29 lists the default values for interfaces and for ATM permanent virtual circuits (PVCs).

Table 29 Default Number of Dynamic Queues as a Function of Interface Bandwidth

Bandwidth Range	Number of Dynamic Queues
Less than or equal to 64 kbps	16
More than 64 kbps and less than or equal to 128 kbps	32
More than 128 kbps and less than or equal to 256 kbps	64
More than 256 kbps and less than or equal to 512 kbps	128
More than 512 kbps	256

Table 30 lists the default number of dynamic queues in relation to ATM PVC bandwidth.

Table 30 Default Number of Dynamic Queues as a Function of ATM PVC Bandwidth

Bandwidth Range	Number of Dynamic Queues
Less than or equal to 128 kbps	16
More than 128 kbps and less than or equal to 512 kbps	32

Table 30 Default Number of Dynamic Queues as a Function of ATM PVC Bandwidth

Bandwidth Range	Number of Dynamic Queues
More than 512 kbps and less than or equal to 2000 kbps	64
More than 2000 kbps and less than or equal to 8000 kbps	128
More than 8000 kbps	256

Based on the number of reserved queues for WFQ, Cisco IOS software assigns a conversation or queue number as shown in the [Table 9](#).

Table 31 Conversation Numbers Assigned to Queues

Number	Type of Traffic
1 to 256	General flow-based traffic queues. Traffic that does not match to a user-created class will match to class-default and one of the flow-based queues.
257 to 263	Reserved for Cisco Discovery Protocol (formerly known as CDP) and for packets marked with an internal high-priority flag.
264	Reserved queue for the priority class (classes configured with the priority command). Look for the “Strict Priority” value for the class in the show policy-map interface output. The priority queue uses a conversation ID equal to the number of dynamic queues, plus 8.
265 and higher	Queues for user-created classes.

Confirming the Service Policy

This task tests the packets matched counter and your service policy. Ensure that the traffic flow matches the input or output parameter of the policy. For example, downloading a file from an FTP server generates congestion in the receive direction because the server sends large MTU-sized frames, and the client PC returns small acknowledgments (ACKs).

SUMMARY STEPS

1. Simulate congestion
2. **enable**
3. **configure terminal**
4. **interface atm slot/0. subinterface-number {multipoint | point-to-point}**
5. **ip address ip-address mask [secondary]**
6. **pvc [name] vpi/vci [ces | ilmi | qsaal | smds]**
7. **tx-ring-limit ring-limit**
8. **service-policy {input | output} policy-map-name**

DETAILED STEPS

	Command or Action	Purpose
Step 1	Simulate congestion with an extended ping using a large ping size and a large number of pings. Also, try downloading a large file from an FTP server.	The file constitutes “disturbing” data and fills the interface bandwidth.
Step 2	enable Example: Router> enable	Enables privileged EXEC mode. <ul style="list-style-type: none"> Enter your password if prompted.
Step 3	configure terminal Example: Router# configure terminal	Enters global configuration mode.
Step 4	interface atm slot/0. subinterface-number {multipoint point-to-point} Example: Router(config)# interface atm 1/0.1 point-to-point}	Enters interface configuration mode.
Step 5	ip address ip-address mask [secondary] Example: Router(config-if)# ip address 10.1.1.1 255.255.255.0	Specifies the IP address of the interface you want to test.
Step 6	pvc [name] vpi/vci [ces ilmi qsaal smds] Example: Router(config-if)# pvc cisco 0/5	Creates or assigns a name to an ATM PVC, optionally specifies the encapsulation type on an ATM PVC, and enters interface-ATM-VC configuration mode.
Step 7	tx-ring-limit ring-limit Example: Router(config-if-atm-vc)# tx-ring-limit 10	Reduces the size of the transmit ring of the interface. Lowering this value accelerates the use of the QoS in the Cisco IOS software. <ul style="list-style-type: none"> Specify the ring limit as the number of packets for 2600 and 3600 series routers, or as the number of memory particles for 7200 and 7500 series routers.
Step 8	service-policy {input output} policy-map-name Example: Router(config-if-atm-vc)# service-policy output policy9	Attaches a policy map to an input interface or VC, or an output interface or VC, to be used as the service policy for that interface or VC. <ul style="list-style-type: none"> Note that the packets matched counter is a part of queueing feature and is available only on service policies attached in output direction.

Configuration Examples for Implementing QoS for IPv6

This section provides the following configuration examples:

- [Verification of CEF Switching: Example, page 467](#)
- [Matching DSCP Value: Example, page 467](#)

Verification of CEF Switching: Example

The following is sample output from the **show cef interface detail** command for Ethernet interface 1/0/0. Use this command to verify that CEF switching is enabled for policy decisions to occur. Notice that the display shows that CEF switching is enabled.

```
Router# show cef interface Ethernet 1/0/0 detail

Ethernet1/0/0 is up (if_number 9)
  Corresponding hwidb fast_if_number 9
  Corresponding hwidb firstsw->if_number 9
  Internet address is 10.2.61.8/24
  ICMP redirects are always sent
  Per packet load-sharing is disabled
  IP unicast RPF check is disabled
  Inbound access list is not set
  Outbound access list is not set
  IP policy routing is disabled
  Hardware idb is Ethernet1/0/0
  Fast switching type 1, interface type 5
  IP Distributed CEF switching enabled
  IP Feature Fast switching turbo vector
  IP Feature CEF switching turbo vector
  Input fast flags 0x0, Output fast flags 0x0
  ifindex 7(7)
  Slot 1 Slot unit 0 VC -1
  Transmit limit accumulator 0x48001A82 (0x48001A82)
  IP MTU 1500
```

Matching DSCP Value: Example

The following example shows how to configure the service policy called priority50 and attach service policy priority50 to an interface. In this example, the **match dscp** command includes the optional **ip** keyword, meaning that the match is for IPv4 packets only. The class map called ipdscp15 will evaluate all packets entering interface Fast Ethernet 1/0/0. If the packet is an IPv4 packet and has a DSCP value of 15, the packet will be treated as priority traffic and will be allocated with bandwidth of 50 kbps.

```
Router(config)# class-map ipdscp15
Router(config-cmap)# match ip dscp 15
Router(config)# exit
Router(config)# policy-map priority50
Router(config-pmap)# class ipdscp15
Router(config-pmap-c)# priority 50
Router(config-pmap-c)# exit
Router(config-pmap)# exit
Router(config)# interface fa1/0/0
Router(config-if)# service-policy input priority55
```

To match on IPv6 packets only, use the **match dscp** command without the **ip** keyword preceded by the **match protocol** command. Ensure that the class map has the **match-all** attribute (which is the default).

```
Router(config)# class-map ipdscp15
Router(config-cmap)# match protocol ipv6
Router(config-cmap)# match dscp 15
Router(config)# exit
```

To match packets on both IPv4 and IPv6 protocols, use the **match dscp** command:

```
Router(config)# class-map ipdscp15
Router(config-cmap)# match dscp 15
Router(config)# exit
```

Additional References

The following sections provide references related to QoS for IPv6:

Related Documents

Related Topic	Document Title
QoS features	<i>Cisco IOS Quality of Service Solutions Configuration Guide, Release 12.4</i> <i>Cisco IOS Quality of Service Solutions Command Reference, Release 12.4</i>
Enhancements for packet marking	<i>Enhanced Packet Marking</i>
IPv4 configuration and command reference information	<i>Cisco IOS Release 12.4 Configuration Guides and Command References</i>

MIBs

MIBs	MIBs Link
No new or modified MIBs are supported by this feature, and support for existing MIBs has not been modified by this feature.	To locate and download MIBs for selected platforms, Cisco IOS releases, and feature sets, use Cisco MIB Locator found at the following URL: http://www.cisco.com/go/mibs

RFCs

RFCs	Title
RFC 2474	<i>Definition of the Differentiated Services Field (DS Field) in the IPv4 and IPv6 Headers</i>
RFC 2475	<i>An Architecture for Differentiated Services Framework</i>
RFC 2597	<i>Assured Forwarding PHB</i>
RFC 2598	<i>An Expedited Forwarding PHB</i>
RFC 2640	<i>Internet Protocol, Version 6 Specification</i>

RFCs	Title
RFC 2697	<i>A Single Rate Three Color Marker</i>
RFC 2698	<i>A Two Rate Three Color Marker</i>

Technical Assistance

Description	Link
The Cisco Technical Support website contains thousands of pages of searchable technical content, including links to products, technologies, solutions, technical tips, and tools. Registered Cisco.com users can log in from this page to access even more content.	http://www.cisco.com/techsupport



Implementing RIP for IPv6

This module describes how to configure Routing Information Protocol for IPv6. RIP is a distance-vector routing protocol that uses hop count as a routing metric. RIP is an Interior Gateway Protocol (IGP) most commonly used in smaller networks.

Finding Support Information for Platforms and Cisco IOS Software Images

Use Cisco Feature Navigator to find information about platform support and Cisco IOS software image support. Access Cisco Feature Navigator at <http://www.cisco.com/go/fn>. You must have an account on Cisco.com. If you do not have an account or have forgotten your username or password, click **Cancel** at the login dialog box and follow the instructions that appear.

Contents

- [Prerequisites for Implementing RIP for IPv6, page 471](#)
- [Information About Implementing RIP for IPv6, page 472](#)
- [How to Implement RIP for IPv6, page 472](#)
- [Configuration Examples for IPv6 RIP, page 483](#)
- [Where to Go Next, page 483](#)
- [Additional References, page 484](#)

Prerequisites for Implementing RIP for IPv6

- This module assumes that you are familiar with IPv6 addressing and basic configuration. Refer to the *Implementing Basic Connectivity for IPv6* module for more information.
- This module assumes that you are familiar with IPv4. Refer to the publications referenced in the “[Related Documents](#)” section for IPv4 configuration and command reference information, as needed.

[Table 32](#) identifies the earliest release for each early-deployment train in which the feature became available.

Table 32 Minimum Required Cisco IOS Release

Feature	Minimum Required Cisco IOS Release by Release Train
RIP enhancements for IPv6	12.2(2)T, 12.0(21)ST, 12.0(22)S, 12.2(14)S, 12.3, 12.3(2)T, 12.4, 12.4(2)T, 12.2(28)SB, 12.2(33)SRA
Route redistribution	12.2(2)T, 12.0(21)ST, 12.0(22)S, 12.2(14)S, 12.3, 12.3(2)T, 12.4, 12.4(2)T, 12.2(28)SB, 12.2(33)SRA

Information About Implementing RIP for IPv6

To configure IPv6 RIP, you need to understand the following concept:

- [RIP for IPv6, page 472](#)

RIP for IPv6

IPv6 RIP functions the same and offers the same benefits as RIP in IPv4. RIP enhancements for IPv6, detailed in RFC 2080, include support for IPv6 addresses and prefixes, and the use of the all-RIP-routers multicast group address FF02::9 as the destination address for RIP update messages. New commands specific to RIP in IPv6 were also added to the Cisco IOS command-line interface (CLI).

In the Cisco IOS software implementation of IPv6 RIP each IPv6 RIP process maintains a local routing table, referred to as a Routing Information Database (RIB). The IPv6 RIP RIB contains a set of best-cost IPv6 RIP routes learned from all its neighboring networking devices. If IPv6 RIP learns the same route from two different neighbors, but with different costs, it will store only the lowest cost route in the local RIB. The RIB also stores any expired routes that the RIP process is advertising to its neighbors running RIP. IPv6 RIP will try to insert every non-expired route from its local RIB into the master IPv6 RIB. If the same route has been learned from a different routing protocol with a better administrative distance than IPv6 RIP, the RIP route will not be added to the IPv6 RIB but the RIP route will still exist in the IPv6 RIP RIB.

How to Implement RIP for IPv6

When configuring supported routing protocols in IPv6, you must create the routing process, enable the routing process on interfaces, and customize the routing protocol for your particular network.



Note

The following sections describe the configuration tasks for creating an IPv6 RIP routing process and enabling the routing process on interfaces. The following sections do not provide in-depth information on customizing RIP because the protocol functions the same in IPv6 as it does in IPv4. Refer to the publications referenced in the “[Related Documents](#)” section for further IPv6 and IPv4 configuration and command reference information.

The tasks in the following sections explain how to configure IPv6 RIP. Each task in the list is identified as either required or optional:

This section contains the following procedures:

- [Enabling IPv6 RIP, page 473](#) (required)
- [Customizing IPv6 RIP, page 474](#) (optional)
- [Redistributing Routes into an IPv6 RIP Routing Process, page 475](#) (optional)
- [Configuring Tags for RIP Routes, page 476](#) (optional)
- [Filtering IPv6 RIP Routing Updates, page 477](#) (optional)
- [Verifying IPv6 RIP Configuration and Operation, page 479](#) (optional)

Enabling IPv6 RIP

This task explains how to create an IPv6 RIP process and enable the specified IPv6 RIP process on an interface.

Prerequisites

Before configuring the router to run IPv6 RIP, globally enable IPv6 using the **ipv6 unicast-routing** global configuration command, and enable IPv6 on any interfaces on which IPv6 RIP is to be enabled. For details on basic IPv6 connectivity tasks, refer to the *Implementing Basic Connectivity for IPv6* module.

SUMMARY STEPS

1. **enable**
2. **configure terminal**
3. **interface** *type number*
4. **ipv6 rip** *name* **enable**

DETAILED STEPS

	Command or Action	Purpose
Step 1	enable Example: Router> enable	Enables privileged EXEC mode. <ul style="list-style-type: none"> • Enter your password if prompted.
Step 2	configure terminal Example: Router# configure terminal	Enters global configuration mode.

	Command or Action	Purpose
Step 3	interface <i>type number</i> Example: Router(config)# interface Ethernet 0/0	Specifies the interface type and number, and enters interface configuration mode.
Step 4	ipv6 rip <i>name enable</i> Example: Router(config-if)# ipv6 rip process1 enable	Enables the specified IPv6 RIP routing process on an interface.

If you want to set or change a global value, follow steps 1 and 2, and then use the optional **ipv6 router rip** *name* command in global configuration mode.

Customizing IPv6 RIP

This optional task explains how to configure the maximum numbers of equal-cost paths that IPv6 RIP will support, adjust the IPv6 RIP timers, and originate a default IPv6 route.

SUMMARY STEPS

1. **enable**
2. **configure terminal**
3. **ipv6 router rip** *word*
4. **maximum-paths** *number-paths*
5. **exit**
6. **interface** *type number*
7. **ipv6 rip** *name default-information* {**only** | **originate**} [**metric** *metric-value*]

DETAILED STEPS

	Command or Action	Purpose
Step 1	enable Example: Router> enable	Enables privileged EXEC mode. <ul style="list-style-type: none"> • Enter your password if prompted.
Step 2	configure terminal Example: Router# configure terminal	Enters global configuration mode.
Step 3	ipv6 router rip <i>word</i> Example: Router(config)# ipv6 router rip cisco	Configures an IPv6 RIP routing process and enters router configuration mode for the IPv6 RIP routing process. <ul style="list-style-type: none"> • Use the <i>word</i> argument to identify a specific IPv6 RIP routing process.

	Command or Action	Purpose
Step 4	<p>maximum-paths <i>number-paths</i></p> <p>Example: Router(config-router)# maximum-paths 1</p>	<p>(Optional) Defines the maximum number of equal-cost routes that IPv6 RIP can support.</p> <ul style="list-style-type: none"> The <i>number-paths</i> argument is an integer from 1 to 64. The default for RIP is four paths.
Step 5	<p>exit</p> <p>Example: Router(config-if)# exit</p>	Exits interface configuration mode and enters global configuration mode.
Step 6	<p>interface <i>type number</i></p> <p>Example: Router(config)# interface Ethernet 0/0</p>	Specifies the interface type and number, and enters interface configuration mode.
Step 7	<p>ipv6 rip <i>name</i> default-information {only originate} [metric <i>metric-value</i>]</p> <p>Example: Router(config-if)# ipv6 rip cisco default-information originate</p>	<p>(Optional) Originates the IPv6 default route (::/0) into the specified RIP routing process updates sent out of the specified interface.</p> <p>Note To avoid routing loops after the IPv6 default route (::/0) is originated out of any interface, the routing process ignores all default routes received on any interface.</p> <ul style="list-style-type: none"> Specifying the only keyword originates the default route (::/0) but suppresses all other routes in the updates sent on this interface. Specifying the originate keyword originates the default route (::/0) in addition to all other routes in the updates sent on this interface.

Redistributing Routes into an IPv6 RIP Routing Process

RIP supports the use of a route map to select routes for redistribution. Routes may be specified by prefix, using a route-map prefix list, or by tag, using the route-map “match tag” function.

The maximum metric that RIP can advertise is 16, and a metric of 16 denotes a route that is unreachable. Therefore, if you are redistributing routes with metrics greater than or equal to 16, then by default RIP will advertise them as unreachable. These routes will not be used by neighboring routers. The user must configure a redistribution metric of less than 15 for these routes.



Note

You must to advertise a route with metric of 15 or less. A RIP router always adds an interface cost—the default is 1—onto the metric of a received route. If you advertise a route with metric 15, your neighbor will add 1 to it, making a metric of 16. Because a metric of 16 is unreachable, your neighbor will not install the route in the routing table.

If no metric is specified, then the current metric of the route is used. To find the current metric of the route, enter the **show ipv6 route** command.

This task explains how to redistribute tagged routes into an IPv6 RIP routing process.

SUMMARY STEPS

1. **enable**
2. **configure terminal**
3. **interface** *type number*
4. **ipv6 rip name enable**
5. **redistribute protocol** [*process-id*] {**level-1** | **level-1-2** | **level-2**} [**metric** *metric-value*] [**metric-type** {**internal** | **external**}] [**route-map** *map-name*]

DETAILED STEPS

	Command or Action	Purpose
Step 1	enable Example: Router> enable	Enables privileged EXEC mode. <ul style="list-style-type: none"> • Enter your password if prompted.
Step 2	configure terminal Example: Router# configure terminal	Enters global configuration mode.
Step 3	interface <i>type number</i> Example: Router(config)# interface Ethernet 0/0	Specifies the interface type and number, and enters interface configuration mode.
Step 4	ipv6 rip word enable Example: Router(config-if)# ipv6 router one enable	Enables an IPv6 Routing Information Protocol (RIP) routing process on an interface.
Step 5	redistribute protocol [<i>process-id</i>] { level-1 level-1-2 level-2 } [metric <i>metric-value</i>] [metric-type { internal external }] [route-map <i>map-name</i>] Example: Router(config-router)# redistribute bgp 65001 route-map bgp-to-rip	Redistributes the specified routes into the IPv6 RIP routing process. <ul style="list-style-type: none"> • The <i>protocol</i> argument can be one of the following keywords: bgp, connected, isis, rip, or static. • The rip keyword and <i>process-id</i> argument specify an IPv6 RIP routing process. <p>Note The connected keyword refers to routes that are established automatically by assigning IPv6 addresses to an interface.</p>

Configuring Tags for RIP Routes

When performing route redistribution, you can associate a numeric tag with a route. The tag is advertised with the route by RIP and will be installed along with the route in neighboring router's routing table.

If you redistribute a tagged route (for example, a route in the IPv6 routing table that already has a tag) into RIP, then RIP will automatically advertise the tag with the route. If you use a redistribution route map to specify a tag, then RIP will use the route map tag in preference to the routing table tag.

The following task explains how to set route tags using a route map.

SUMMARY STEPS

1. **enable**
2. **configure terminal**
3. **route-map** *map-tag* [**permit** | **deny**] [*sequence-number*]
4. **match ipv6 address** {**prefix-list** *prefix-list-name* | *access-list-name*}
5. **set tag** *tag-value*

DETAILED STEPS

	Command or Action	Purpose
Step 1	enable Example: Router> enable	Enables privileged EXEC mode. <ul style="list-style-type: none"> • Enter your password if prompted.
Step 2	configure terminal Example: Router# configure terminal	Enters global configuration mode.
Step 3	route-map <i>map-tag</i> [permit deny] [<i>sequence-number</i>] Example: Router(config)# route-map bgp-to-rip permit 10	Defines a route map, and enters route-map configuration mode. <ul style="list-style-type: none"> • Follow this step with a match command.
Step 4	match ipv6 address { prefix-list <i>prefix-list-name</i> <i>access-list-name</i> }	Specifies a list of IPv6 prefixes to be matched.
Step 5	set tag <i>tag-value</i> Example: Router(config-route-map)# set tag 4	Sets the tag value to associate with the redistributed routes.

Filtering IPv6 RIP Routing Updates

Route filtering using distribute lists provides control over the routes RIP receives and advertises. This control may be exercised globally or per interface.

This task explains how to apply a prefix list to IPv6 RIP routing updates that are received or sent on an interface.

IPv6 Distribute Lists

Filtering is controlled by distribute lists. Input distribute lists control route reception, and input filtering is applied to advertisements received from neighbors. Only those routes that pass input filtering will be inserted in the RIP local routing table and become candidates for insertion into the IPv6 routing table.

Output distribute lists control route advertisement; Output filtering is applied to route advertisements sent to neighbors. Only those routes passing output filtering will be advertised.

Global distribute lists (which are distribute lists that do not apply to a specified interface) apply to all interfaces. If a distribute list specifies an interface, then that distribute list applies only to that interface.

An interface distribute list always takes precedence. For example, for a route received at an interface, with the interface filter set to deny, and the global filter set to permit, the route is blocked, the interface filter is passed, the global filter is blocked, and the route is passed.

IPv6 Prefix List Operand Keywords

IPv6 prefix lists are used to specify certain prefixes or a range of prefixes that must be matched before a permit or deny statement can be applied. Two operand keywords can be used to designate a range of prefix lengths to be matched. A prefix length of less than, or equal to, a value is configured with the **le** keyword. A prefix length greater than, or equal to, a value is specified using the **ge** keyword. The **ge** and **le** keywords can be used to specify the range of the prefix length to be matched in more detail than the usual *ipv6-prefix/prefix-length* argument. For a candidate prefix to match against a prefix list entry three conditions can exist:

- The candidate prefix must match the specified prefix list and prefix length entry.
- The value of the optional **le** keyword specifies the range of allowed prefix lengths from the *prefix-length* argument up to, and including, the value of the **le** keyword.
- The value of the optional **ge** keyword specifies the range of allowed prefix lengths from the value of the **ge** keyword up to, and including, 128.



Note

Note that the first condition must match before the other conditions take effect.

An exact match is assumed when the **ge** or **le** keywords are not specified. If only one keyword operand is specified then the condition for that keyword is applied, and the other condition is not applied. The *prefix-length* value must be less than the **ge** value. The **ge** value must be less than, or equal to, the **le** value. The **le** value must be less than or equal to 128.

SUMMARY STEPS

1. **enable**
2. **configure terminal**
3. **ipv6 prefix list** *prefix-list-name* [**seq** *seq-number*] {**deny** *ipv6-prefix/prefix-length* | **description** *text*} [**ge** *ge-value*] [**le** *le-value*]
4. **ipv6 prefix list** *prefix-list-name* [**seq** *seq-number*] {**permit** *ipv6-prefix/prefix-length* | **description** *text*} [**ge** *ge-value*] [**le** *le-value*]
5. Repeat Steps 3 and 4 as many times as necessary to build the prefix list.

6. **ipv6 router rip** *name*
7. **distribute-list prefix-list** *prefix-list-name* {**in** | **out**} [*interface-type interface-number*]

DETAILED STEPS

	Command or Action	Purpose
Step 1	<p>enable</p> <p>Example: Router> enable</p>	<p>Enables privileged EXEC mode.</p> <ul style="list-style-type: none"> • Enter your password if prompted.
Step 2	<p>configure terminal</p> <p>Example: Router# configure terminal</p>	<p>Enters global configuration mode.</p>
Step 3	<p>ipv6 prefix list <i>prefix-list-name</i> [seq <i>seq-number</i>] {deny <i>ipv6-prefix/prefix-length</i> description <i>text</i>} [ge <i>ge-value</i>] [le <i>le-value</i>]</p> <p>Example: Router(config)# ipv6 prefix-list abc permit 2001:0db8::/16</p>	<p>Creates an entry in the IPv6 prefix list.</p>
Step 4	<p>ipv6 prefix list <i>prefix-list-name</i> [seq <i>seq-number</i>] {deny <i>ipv6-prefix/prefix-length</i> description <i>text</i>} [ge <i>ge-value</i>] [le <i>le-value</i>]</p> <p>Example: Router(config)# ipv6 prefix-list abc deny ::/0</p>	<p>Creates an entry in the IPv6 prefix list.</p>
Step 5	<p>Repeat Steps 3 and 4 as many times as necessary to build the prefix list.</p>	<p>—</p>
Step 6	<p>ipv6 router rip <i>name</i></p> <p>Example: Router(config)# ipv6 router rip cisco</p>	<p>Configures an IPv6 RIP routing process.</p>
Step 7	<p>distribute-list prefix-list <i>prefix-list-name</i> {in out} [<i>interface-type interface-number</i>]</p> <p>Example: Router(config-rtr-rip)# distribute-list prefix-list cisco in ethernet 0/0</p>	<p>Applies a prefix list to IPv6 RIP routing updates that are received or sent on an interface.</p>

Verifying IPv6 RIP Configuration and Operation

A user may want to check IPv6 RIP configuration and operation. Some of the following scenarios may occur for which a user can then enable the following **show** and **debug** commands:

- “Why isn’t a certain route appearing in my IPv6 routing table?”
- “Am I receiving routes via RIP?”

- “Is a certain route being filtered?”
- “Someone at a route site told me that I am not advertising a certain route. True?”

This task explains how to display information to verify the configuration and operation of IPv6 RIP.

SUMMARY STEPS

1. **show ipv6 rip** [*name*] [**database** | **next-hops**]
2. **show ipv6 route** [*ipv6-address* | *ipv6-prefix/prefix-length* | *protocol* | *interface-type* | *interface-number*]
3. **enable**
4. **debug ipv6 rip** [*interface-type* *interface-number*]

DETAILED STEPS

	Command or Action	Purpose
Step 1	show ipv6 rip [<i>name</i>] [database next-hops] Example: Router> show ipv6 rip cisco database	(Optional) Displays information about current IPv6 RIP processes. <ul style="list-style-type: none"> • In this example, IPv6 RIP process database information is displayed for the specified IPv6 RIP process.
Step 2	show ipv6 route [<i>ipv6-address</i> <i>ipv6-prefix/prefix-length</i> <i>protocol</i> <i>interface-type</i> <i>interface-number</i>] Example: Router> show ipv6 route rip	(Optional) Displays the current contents of the IPv6 routing table. <ul style="list-style-type: none"> • In this example, only IPv6 RIP routes are displayed.
Step 3	enable Example: Router> enable	Enables higher privilege levels, such as privileged EXEC mode. <ul style="list-style-type: none"> • Enter your password if prompted.
Step 4	debug ipv6 rip [<i>interface-type</i> <i>interface-number</i>] Example: Router# debug ipv6 rip	(Optional) Displays debugging messages for IPv6 RIP routing transactions.

Output Examples

This section provides the following output examples:

- [Sample Output for the show ipv6 rip Command, page 481](#)
- [Sample Output for the show ipv6 route Command, page 482](#)
- [Sample Output for the debug ipv6 rip Command, page 482](#)

Sample Output for the show ipv6 rip Command

In the following example, output information about all current IPv6 RIP processes is displayed using the **show ipv6 rip** user EXEC command:

```
Router> show ipv6 rip

RIP process "cisco", port 521, multicast-group FF02::9, pid 62
  Administrative distance is 120. Maximum paths is 1
  Updates every 5 seconds, expire after 15
  Holddown lasts 10 seconds, garbage collect after 30
  Split horizon is on; poison reverse is off
  Default routes are generated
  Periodic updates 223, trigger updates 1
Interfaces:
  Ethernet0/0
Redistribution:
  Redistributing protocol bgp 65001 route-map bgp-to-rip
```

In the following example, output information about a specified IPv6 RIP process database is displayed using the **show ipv6 rip** user EXEC command with the *name* argument and the **database** keyword. In the following output for the IPv6 RIP process named cisco, timer information is displayed, and route 2001:0db8::16/64 has a route tag set:

```
Router> show ipv6 rip cisco database

RIP process "cisco", local RIB
2001:0db8::/64, metric 2
  Ethernet0/0/FE80::A8BB:CCFF:FE00:B00, expires in 13 secs
2001:0db8::/16, metric 2 tag 4, installed
  Ethernet0/0/FE80::A8BB:CCFF:FE00:B00, expires in 13 secs
2001:0db8:1::/16, metric 2 tag 4, installed
  Ethernet0/0/FE80::A8BB:CCFF:FE00:B00, expires in 13 secs
2001:0db8:2::/16, metric 2 tag 4, installed
  Ethernet0/0/FE80::A8BB:CCFF:FE00:B00, expires in 13 secs
::/0, metric 2, installed
  Ethernet0/0/FE80::A8BB:CCFF:FE00:B00, expires in 13 secs
```

In the following example, output information for a specified IPv6 RIP process is displayed using the **show ipv6 rip** user EXEC command with the *name* argument and the **next-hops** keyword:

```
Router> show ipv6 rip cisco next-hops

RIP process "cisco", Next Hops
  FE80::A8BB:CCFF:FE00:A00/Ethernet0/0 [4 paths]
```



Note

For a description of each output display field, refer to the **show ipv6 rip** command in the *IPv6 for Cisco IOS Command Reference*.

Sample Output for the show ipv6 route Command

The current metric of the route can be found by entering the **show ipv6 route** command. In the following example, output information for all IPv6 RIP routes is displayed using the **show ipv6 route** user EXEC command with the **rip** protocol keyword:

```
Router> show ipv6 route rip

IPv6 Routing Table - 17 entries
Codes: C - Connected, L - Local, S - Static, R - RIP, B - BGP
       U - Per-user Static route
       I1 - ISIS L1, I2 - ISIS L2, IA - ISIS interarea
       O - OSPF intra, OI - OSPF inter, OE1 - OSPF ext 1, OE2 - OSPF ext 2
R   2001:0db8:1::/32 [120/2]
    via FE80::A8BB:CCFF:FE00:A00, Ethernet0/0
R   2001:0db8:2::/32 [120/2]
    via FE80::A8BB:CCFF:FE00:A00, Ethernet0/0
R   2001:0db8:3::/32 [120/2]
    via FE80::A8BB:CCFF:FE00:A00, Ethernet0/0
```

Sample Output for the debug ipv6 rip Command

In the following example, debugging messages for IPv6 RIP routing transactions are displayed using the **debug ipv6 rip** privileged EXEC command:



Note

By default, the system sends the output from **debug** commands and system error messages to the console. To redirect debugging output, use the **logging** command options within privileged EXEC mode. Possible destinations include the console, virtual terminals, internal buffer, and UNIX hosts running a syslog server. For complete information on **debug** commands and redirecting debugging output, refer to the *Cisco IOS Debug Command Reference*, Release 12.4.

```
Router# debug ipv6 rip

RIPng: Sending multicast update on Ethernet0/0 for cisco
      src=FE80::A8BB:CCFF:FE00:B00
      dst=FF02::9 (Ethernet0/0)
      sport=521, dport=521, length=112
      command=2, version=1, mbz=0, #rte=5
      tag=0, metric=1, prefix=2001:0db8::/64
      tag=4, metric=1, prefix=2001:0db8:1::/16
      tag=4, metric=1, prefix=2001:0db8:2::/16
      tag=4, metric=1, prefix=2001:0db8:3::/16
      tag=0, metric=1, prefix=::/0
RIPng: Next RIB walk in 10032
RIPng: response received from FE80::A8BB:CCFF:FE00:A00 on Ethernet0/0 for cisco
      src=FE80::A8BB:CCFF:FE00:A00 (Ethernet0/0)
      dst=FF02::9
      sport=521, dport=521, length=92
      command=2, version=1, mbz=0, #rte=4
      tag=0, metric=1, prefix=2001:0db8::/64
      tag=0, metric=1, prefix=2001:0db8:1::/32
      tag=0, metric=1, prefix=2001:0db8:2::/32
      tag=0, metric=1, prefix=2001:0db8:3::/32
```

Configuration Examples for IPv6 RIP

This section provides the following configuration examples:

- [IPv6 RIP Configuration: Example, page 483](#)

IPv6 RIP Configuration: Example

In the following example, the IPv6 RIP process named cisco is enabled on the router and on Ethernet interface 0/0. The IPv6 default route (::/0) is advertised in addition to all other routes in router updates sent on Ethernet interface 0/0. Additionally, BGP routes are redistributed into the RIP process named cisco according to a route map where routes that match a prefix list are also tagged. The number of parallel paths is set to one to allow the route tagging, and the IPv6 RIP timers are adjusted. A prefix list named eth0/0-in-flt filters inbound routing updates on Ethernet interface 0/0.

```
ipv6 router rip cisco
 maximum-paths 1
 redistribute bgp 65001 route-map bgp-to-rip
 distribute-list prefix-list eth0/0-in-flt in Ethernet0/0
!
interface Ethernet0/0
 ipv6 address 2001:0db8::/64 eui-64
 ipv6 rip cisco enable
 ipv6 rip cisco default-information originate
!
ipv6 prefix-list bgp-to-rip-flt seq 10 deny 2001:0db8:3::/16 le 128
ipv6 prefix-list bgp-to-rip-flt seq 20 permit 2001:0db8:1::/8 le 128
!
ipv6 prefix-list eth0/0-in-flt seq 10 deny ::/0
ipv6 prefix-list eth0/0-in-flt seq 15 permit ::/0 le 128
!
route-map bgp-to-rip permit 10
 match ipv6 address prefix-list bgp-to-rip-flt
 set tag 4
```

Where to Go Next

If you want to implement more IPv6 routing protocols, see the *Implementing IS-IS for IPv6* or *Implementing Multiprotocol BGP for IPv6* module.

Additional References

For additional information related to implementing RIP for IPv6, see the following sections.

Related Documents

Related Topic	Document Title
RIP configuration tasks	“Configuring Routing Information Protocol” chapter in the <i>Cisco IOS IP Configuration Guide</i> , Release 12.4
RIP commands: complete command syntax, command mode, defaults, usage guidelines, and examples	<i>Cisco IOS IP Command Reference, Volume 2 of 3: Routing Protocols</i> , Release 12.4
IPv6 supported feature list	<i>Start Here: Cisco IOS Software Release Specifics for IPv6 Features</i>
IPv6 commands: complete command syntax, command mode, defaults, usage guidelines, and examples	<i>IPv6 for Cisco IOS Command Reference</i>
IPv4 configuration and command reference information	<i>Cisco IOS Release 12.4 Configuration Guides and Command References</i>

Standards

Standards	Title
No new or modified standards are supported by this feature, and support for existing standards has not been modified by this feature.	—

MIBs

MIBs	MIBs Link
No new or modified MIBs are supported by this feature, and support for existing MIBs has not been modified by this feature.	To locate and download MIBs for selected platforms, Cisco IOS releases, and feature sets, use Cisco MIB Locator found at the following URL: http://www.cisco.com/go/mibs

RFCs

RFCs	Title
RFC 2080	<i>RIPng for IPv6</i>

Technical Assistance

Description	Link
The Cisco Technical Support website contains thousands of pages of searchable technical content, including links to products, technologies, solutions, technical tips, and tools. Registered Cisco.com users can log in from this page to access even more content.	http://www.cisco.com/techsupport



Implementing Static Routes for IPv6

This module describes how to configure static routes for IPv6. Routing defines the paths over which packets travel in the network. Manually configured static routes may be used instead of dynamic routing protocols for smaller networks or for sections of a network that have only one path to an outside network. Lack of redundancy limits the usefulness of static routes, and in larger networks manual reconfiguration of routes can become a large administrative overhead.

Finding Support Information for Platforms and Cisco IOS Software Images

Use Cisco Feature Navigator to find information about platform support and Cisco IOS software image support. Access Cisco Feature Navigator at <http://www.cisco.com/go/fn>. You must have an account on Cisco.com. If you do not have an account or have forgotten your username or password, click **Cancel** at the login dialog box and follow the instructions that appear.

Contents

- [Prerequisites for Implementing Static Routes for IPv6, page 487](#)
- [Restrictions for Implementing Static Routes for IPv6, page 488](#)
- [Information About Implementing Static Routes for IPv6, page 488](#)
- [How to Implement Static Routes for IPv6, page 490](#)
- [Configuration Examples for Implementing Static Routes for IPv6, page 496](#)
- [Where to Go Next, page 501](#)
- [Additional References, page 502](#)

Prerequisites for Implementing Static Routes for IPv6

- This document assumes that you are familiar with IPv4. Refer to the publications referenced in the “[Related Documents](#)” section for IPv4 configuration and command reference information. Any differences in functions between the IPv4 and IPv6 environments are documented in *Implementing IPv6 for Cisco IOS* and the *Cisco IOS IPv6 Command Reference*.
- Before configuring the router with a static IPv6 route you must enable the forwarding of IPv6 packets using the **ipv6 unicast-routing** global configuration command, enable IPv6 on at least one interface, and configure an IPv6 address on that interface. For details on basic IPv6 connectivity tasks, refer to the *Implementing Basic Connectivity for IPv6* module.

Table 33 identifies the earliest release for each early-deployment train in which the Static Routes feature became available.

Table 33 Minimum Required Cisco IOS Release

Feature	Minimum Required Cisco IOS Release by Release Train
Static routing	12.2(2)T, 12.0(21)ST, 12.0(22)S, 12.2(14)S, 12.3, 12.3(2)T, 12.4, 12.4(2)T, 12.2(28)SB, 12.2(33)SRA

Restrictions for Implementing Static Routes for IPv6

- IPv6 static routes do not currently support the **tag** and **permanent** keywords of the IPv4 **ip route** command.
- IPv6 does not currently support inserting static routes into virtual routing and forwarding (VRF) tables.

Information About Implementing Static Routes for IPv6

To configure static routes for IPv6, you need to understand the following concepts:

- [Static Routes, page 488](#)
- [Directly Attached Static Routes, page 489](#)
- [Recursive Static Routes, page 489](#)
- [Fully Specified Static Routes, page 490](#)
- [Floating Static Routes, page 490](#)

Static Routes

Networking devices forward packets using route information that is either manually configured or dynamically learned using a routing protocol. Static routes are manually configured and define an explicit path between two networking devices. Unlike a dynamic routing protocol, static routes are not automatically updated and must be manually reconfigured if the network topology changes. The benefits of using static routes include security and resource efficiency. Static routes use less bandwidth than dynamic routing protocols and no CPU cycles are used to calculate and communicate routes. The main disadvantage to using static routes is the lack of automatic reconfiguration if the network topology changes.

Static routes can be redistributed into dynamic routing protocols but routes generated by dynamic routing protocols cannot be redistributed into the static routing table. No algorithm exists to prevent the configuration of routing loops that use static routes.

Static routes are useful for smaller networks with only one path to an outside network and to provide security for a larger network for certain types of traffic or links to other networks that need more control. In general, most networks use dynamic routing protocols to communicate between networking devices but may have one or two static routes configured for special cases.

Directly Attached Static Routes

In directly attached static routes, only the output interface is specified. The destination is assumed to be directly attached to this interface, so the packet destination is used as the next hop address. This example shows such a definition:

```
ipv6 route 2001:0DB8::/32 ethernet1/0
```

The example specifies that all destinations with address prefix 2001:0DB8::/32 are directly reachable via interface Ethernet1/0.

Directly attached static routes are candidates for insertion in the IPv6 routing table only if they refer to a valid IPv6 interface; that is, an interface that is both up and has IPv6 enabled on it.

Recursive Static Routes

In a recursive static route, only the next hop is specified. The output interface is derived from the next hop. This example shows such a definition:

```
ipv6 route 2001:0DB8::/32 2001:0DB8:3000:1
```

This example specifies that all destinations with address prefix 2001:0DB8::/32 are reachable via the host with address 2001:0DB8:3000:1.

A recursive static route is valid (that is, it is a candidate for insertion in the IPv6 routing table) only when the specified next hop resolves, either directly or indirectly, to a valid IPv6 output interface, provided the route does not self-recurse, and the recursion depth does not exceed the maximum IPv6 forwarding recursion depth.

A route self-recurses if it is itself used to resolve its own next hop. For example, suppose we have the following routes in the IPv6 routing table:

```
IPv6 Routing Table - 9 entries
Codes: C - Connected, L - Local, S - Static, R - RIP, B - BGP
       U - Per-user Static route
       I1 - ISIS L1, I2 - ISIS L2, IA - ISIS interarea
       O - OSPF intra, OI - OSPF inter, OE1 - OSPF ext 1, OE2 - OSPF ext 2
R   2001:0DB8::/32 [130/0]
    via ::, Serial2/0
B   2001:0DB8:3000:0/16 [200/45]
    via 2001:0DB8::0104
```

The following examples defines a recursive IPv6 static route:

```
ipv6 route
2001:0DB8::/32 2001:0DB8:3000:1
```

This static route will not be inserted into the IPv6 routing table because it is self-recursive. The next hop of the static route, 2001:0DB8:3000:1, resolves via the BGP route 2001:0DB8:3000:0/16, which is itself a recursive route (that is, it only specifies a next hop). The next hop of the BGP route, 2001:0DB8::0104, resolves via the static route. Therefore, the static route would be used to resolve its own next hop.

It is not normally useful to manually configure a self-recursive static route, although it is not prohibited. However, a recursive static route that has been inserted in the IPv6 routing table may become self-recursive as a result of some transient change in the network learned through a dynamic routing protocol. If this occurs, the fact that the static route has become self-recursive will be detected and it will be removed from the IPv6 routing table, although not from the configuration. A subsequent network change may cause the static route to no longer be self-recursive, in which case it will be re-inserted in the IPv6 routing table.

IPv6 recursive static routes are checked at one-minute intervals. So, a recursive static route may take up to a minute to be inserted into the routing table once its next hop becomes valid. Likewise, it may take a minute or so for the route to disappear from the table if its next hop becomes invalid.

Fully Specified Static Routes

In a fully specified static route, both the output interface and the next hop are specified. This form of static route is used when the output interface is a multi-access one and it is necessary to explicitly identify the next hop. The next hop must be directly attached to the specified output interface. The following example shows a definition of a fully specified static route:

```
ipv6 route 2001:DB8::/32 ethernet1/0 2001:0DB8:3000:1
```

A fully specified route is valid (that is, a candidate for insertion into the IPv6 routing table) when the specified IPv6 interface is IPv6-enabled and up.

Floating Static Routes

Floating static routes are static routes that are used to back up dynamic routes learned through configured routing protocols. A floating static route is configured with a higher administrative distance than the dynamic routing protocol it is backing up. As a result, the dynamic route learned through the routing protocol is always used in preference to the floating static route. If the dynamic route learned through the routing protocol is lost, the floating static route will be used in its place. The following example defines a floating static route:

```
ipv6 route 2001:DB8::/32 ethernet1/0 2001:0DB8:3000:1 210
```

Any of the three types of IPv6 static routes can be used as a floating static route. A floating static route must be configured with an administrative distance that is greater than the administrative distance of the dynamic routing protocol, because routes with smaller administrative distances are preferred.

**Note**

By default, static routes have smaller administrative distances than dynamic routes, so static routes will be used in preference to dynamic routes.

How to Implement Static Routes for IPv6

The following sections explain how to configure static IPv6 routes:

- [Configuring a Static IPv6 Route, page 490](#)
- [Configuring a Floating Static IPv6 Route, page 492](#)
- [Verifying Static IPv6 Route Configuration and Operation, page 494](#)

Configuring a Static IPv6 Route

This task explains how to configure a static default IPv6 route, a static IPv6 route through a point-to-point interface, and a static IPv6 route to a multiaccess interface.

Static Routes in IPv6

Use the **ipv6 route** command to configure IPv6 static routes.

SUMMARY STEPS

1. **enable**
2. **configure terminal**
3. **ipv6 route** *ipv6-prefix/prefix-length* {*ipv6-address* | *interface-type interface-number* [*ipv6-address*]} [*administrative-distance*] [*administrative-multicast-distance* | **unicast** | **multicast**] [**tag tag**]

DETAILED STEPS

	Command or Action	Purpose
Step 1	enable Example: Router> enable	Enables privileged EXEC mode. <ul style="list-style-type: none"> • Enter your password if prompted.
Step 2	configure terminal Example: Router# configure terminal	Enters global configuration mode.
Step 3	ipv6 route <i>ipv6-prefix/prefix-length</i> { <i>ipv6-address</i> <i>interface-type interface-number</i> [<i>ipv6-address</i>]} [<i>administrative-distance</i>] [<i>administrative-multicast-distance</i> unicast multicast] [tag tag] Example: Router(config)# ipv6 route ::/0 serial 2/0	Configures a static IPv6 route. <ul style="list-style-type: none"> • A static default IPv6 route is being configured on a serial interface. • See the syntax examples that immediately follow this table for specific uses of the ipv6 route command for configuring static routes. • Refer to the ipv6 route command entry in the <i>IPv6 for Cisco IOS Software Command Reference</i> for more details on the arguments and keywords used in this command.

Additional Syntax Examples for Configuring Static Routes

In addition to the syntax example included in the [DETAILED STEPS, page 491](#), the following syntax examples illustrate use of the **ipv6 route** for configuring the various types of static routes.

Directly Attached Static Route through Point-to-Point Interface Example Syntax

The following example shows how to configure a directly attached static route through a point-to-point interface.

```
Router(config)# ipv6 route 2001:0DB8::/32 serial 0
```

Directly Attached Static Route on Broadcast Interface Example Syntax

The following example shows how to configure a directly attached static route on a broadcast interface.

```
Router(config)# ipv6 route 2001:0DB8::1/32 ethernet1/0
```

Fully Specified Static Route on Broadcast Interface Example Syntax

The following example shows how to configure a fully specified static route on a broadcast interface.

```
Router(config)# ipv6 route 2001:0DB8::1/32 ethernet1/0 fe80::1
```

Recursive Static Route

In the following example, a static route is being configured to a specified next hop address, from which the output interface is automatically derived.

```
Router(config)# ipv6 route 2001:0DB8::/32 2001:0DB8:2002:1
```

What to Do Next

Proceed to the [“Verifying Static IPv6 Route Configuration and Operation”](#) section.

Configuring a Floating Static IPv6 Route

This task explains how to configure a floating static IPv6 route.

SUMMARY STEPS

1. **enable**
2. **configure terminal**
3. **ipv6 route** *ipv6-prefix/prefix-length* {*ipv6-address* | *interface-type interface-number* [*ipv6-address*]} [*administrative-distance*] [*administrative-multicast-distance* | **unicast** | **multicast**] [**tag** *tag*]

DETAILED STEPS

	Command or Action	Purpose
Step 1	<p>enable</p> <p>Example: Router> enable</p>	<p>Enables privileged EXEC mode.</p> <ul style="list-style-type: none"> • Enter your password if prompted.
Step 2	<p>configure terminal</p> <p>Example: Router# configure terminal</p>	<p>Enters global configuration mode.</p>
Step 3	<p>ipv6 route <i>ipv6-prefix/prefix-length</i> {<i>ipv6-address</i> <i>interface-type interface-number</i> [<i>ipv6-address</i>]} [<i>administrative-distance</i>] [<i>administrative-multicast-distance</i> unicast multicast] [tag tag]</p> <p>Example: Router(config)# ipv6 route 2001:0DB8::/32 serial 2/0 201</p>	<p>Configures a static IPv6 route.</p> <ul style="list-style-type: none"> • In this example, a floating static IPv6 route is being configured. An administrative distance of 200 is configured. • Default administrative distances are as follows: <ul style="list-style-type: none"> – Connected interface—0 – Static route—1 – Enhanced Interior Gateway Routing Protocol (EIGRP) summary route—5 – External Border Gateway Protocol (eBGP)—20 – Internal Enhanced IGRP—90 – IGRP—100 – Open Shortest Path First—110 – Intermediate System-to-Intermediate System (IS-IS)—115 – Routing Information Protocol (RIP)—120 – Exterior Gateway Protocol (EGP)—140 – EIGRP external route—170 – Internal BGP—200 – Unknown—255

Verifying Static IPv6 Route Configuration and Operation

This task explains how to display information to verify the configuration and operation of static IPv6 routes.

Use the **show ipv6 static** command to display a set of static routes and the installed status of each, that is, whether an entry for each route appears in the IPv6 routing table.

Use the **show ipv6 route** command to confirm that installed routes are in the IPv6 routing table and that each route definition reflects the expected cost and metric. If a static route that you have configured does not appear in the IPv6 routing table, it is possible that there is a lower administrative distance from another source in the table, such as from a routing protocol. Such a change to the routing table would occur only if you have specified a non-default administrative distance on the static route.

If a lower administrative distance exists, the static route is “floating” and will be inserted into the routing table only when the route learned through the routing protocol disappears. If there is not a lower administrative distance in the routing table, then the static route should be used.

Use the **show ipv6 static** command with the **detail** keyword to determine what is causing any discrepancy. For example, if the static route is a direct static route, the interface might be down or IPv6 might not be enabled on the interface.

SUMMARY STEPS

1. **enable**
2. **show ipv6 static** [*ipv6-address* | *ipv6-prefix/prefix-length*][**interface** *interface-type interface-number*] [**recursive**] [**detail**]
or
show ipv6 route [*ipv6-address* | *ipv6-prefix/prefix-length* | *protocol* | *interface-type interface-number*]
3. **debug ipv6 routing**

DETAILED STEPS

	Command or Action	Purpose
Step 1	<p>enable</p> <p>Example: Router> enable</p>	<p>Enables privileged EXEC mode.</p> <ul style="list-style-type: none"> Enter your password if prompted.
Step 2	<p>show ipv6 static [<i>ipv6-address</i> <i>ipv6-prefix/prefix-length</i>][interface <i>interface-type interface-number</i>] [recursive] [detail]</p> <p>or</p> <p>show ipv6 route [<i>ipv6-address</i> <i>ipv6-prefix/prefix-length</i> <i>protocol</i> <i>interface-type interface-number</i>]</p> <p>Example: Router# show ipv6 static</p> <p>Example: Router# show ipv6 route static</p>	<p>Displays the current contents of the IPv6 routing table.</p> <ul style="list-style-type: none"> These examples show two different ways of displaying IPv6 static routes. Refer to the show ipv6 static and show ipv6 route command entries in the <i>IPv6 for Cisco IOS Software Command Reference</i> for more details on the arguments and keywords used in this command.
Step 3	<p>debug ipv6 routing</p> <p>Example: Router# debug ipv6 routing</p>	<p>Displays debugging messages for IPv6 routing table updates and route cache updates.</p>

For examples of output from the **show ipv6 static** command, see [Configuration Examples Using the show ipv6 static, show ipv6 route, and debug ipv6 routing Commands](#), page 498.

Configuration Examples for Implementing Static Routes for IPv6

Static routes may be used for a variety of purposes. Common usages include the following:

- Manual summarization
- Traffic discard
- Fixed default route
- Backup route

In many cases, alternative mechanisms exist within Cisco IOS to achieve the same objective. Whether to use static routes or one of the alternative mechanisms depends on local circumstances.

This section provides the following configuration examples:

- [Configuring Manual Summarization Example, page 496](#)
- [Configuring Traffic Discard Example, page 497](#)
- [Configuring a Fixed Default Route Example, page 497](#)
- [Configuring a Floating Static IPv6 Route, page 492](#)
- [Configuration Examples Using the show ipv6 static, show ipv6 route, and debug ipv6 routing Commands, page 498](#)

Configuring Manual Summarization Example

The following example shows a static route being used to summarize local interface prefixes advertised into RIP. The static route also serves as a discard route, discarding any packets received by the router to a 2001:0DB8:1::/48 destination not covered by a more specific interface prefix.

```
Router> enable
Router# configure terminal

Enter configuration commands, one per line. End with CNTL/Z.

Router(config)# interface ethernet0/0
Router(config-if)# ipv6 address 2001:0DB8:2:1234/64
Router(config-if)# exit
Router(config)#
Router(config)# interface ethernet1/0
Router(config-if)# ipv6 address 2001:0DB8:3:1234/64
Router(config-if)# exit
Router(config)#

Router(config)# interface ethernet2/0
Router(config-if)# ipv6 address 2001:0DB8:4:1234/64
Router(config-if)# exit
Router(config)#

Router(config)# interface ethernet3/0
Router(config-if)# ipv6 address 2001:0DB8::1234/64
Router(config-if)# ipv6 rip one enable
Router(config-if)# exit
Router(config)#

Router(config)# ipv6 router rip one
Router(config-rtr)# redistribute static
Router(config-rtr)# exit
Router(config)#
```



```

Router(config)# ipv6 route 2001:0DB8:1:1/48 null0
Router(config)# end
Router#

00:01:30: %SYS-5-CONFIG_I: Configured from console by console

Router# show ipv6 route static

IPv6 Routing Table - 3 entries
Codes: C - Connected, L - Local, S - Static, R - RIP, B - BGP
       U - Per-user Static route
       I1 - ISIS L1, I2 - ISIS L2, IA - ISIS interarea, IS - ISIS summary
       O - OSPF intra, OI - OSPF inter, OE1 - OSPF ext 1, OE2 - OSPF ext 2
       ON1 - OSPF NSSA ext 1, ON2 - OSPF NSSA ext 2
S    2001:0DB8:1::/48 [1/0]
    via ::, Null0

```

Configuring Traffic Discard Example

Configuring a static route to point at interface null0 may be used for discarding traffic to a particular prefix. For example, if it is required to discard all traffic to prefix 2001:0DB8:42:1/64, the following static route would be defined:

```

Router> enable
Router# configure terminal
Enter configuration commands, one per line. End with CNTL/Z.

Router(config)# ipv6 route 2001:0DB8:42:1::/64 null0
Router(config)# end
Router#

00:05:44: %SYS-5-CONFIG_I: Configured from console by console

```

Configuring a Fixed Default Route Example

A default static route is often used in simple router topologies. In the following example, a router is connected to its local site via Ethernet0/0 and to the main corporate network via Serial2/0 and Serial3/0. All nonlocal traffic will be routed over the two serial interfaces.

```

Router(config)# interface ethernet0/0
Router(config-if)# ipv6 address 2001:0DB8:17:1234/64
Router(config-if)# exit

Router(config)# interface Serial2/0
Router(config-if)# ipv6 address 2001:0DB8:1:1234/64
Router(config-if)# exit

Router(config)# interface Serial3/0
Router(config-if)# ipv6 address 2001:0DB8:2:124/64
Router(config-if)# exit

Router(config)# ipv6 route ::/0 Serial2/0
Router(config)# ipv6 route ::/0 Serial3/0
Router(config)# end
Router#

00:06:30: %SYS-5-CONFIG_I: Configured from console by console
Router# show ipv6 route static

```

```

IPv6 Routing Table - 7 entries
Codes: C - Connected, L - Local, S - Static, R - RIP, B - BGP
       U - Per-user Static route
       I1 - ISIS L1, I2 - ISIS L2, IA - ISIS interarea, IS - ISIS summary
       O - OSPF intra, OI - OSPF inter, OE1 - OSPF ext 1, OE2 - OSPF ext 2
       ON1 - OSPF NSSA ext 1, ON2 - OSPF NSSA ext 2
S    ::/0 [1/0]
    via ::, Serial2/0
    via ::, Serial3/0

```

Configuring a Floating Static Route Example

A floating static route often is used to provide a backup path in the event of connectivity failure. In the following example, the router has connectivity to the network core via Serial2/0 and learns the route 2001:0DB8:1:1/32 via IS-IS. If the Serial2/0 interface fails, or if route 2001:0DB8:1:1/32 is no longer learned via IS-IS (indicating loss of connectivity elsewhere in the network), traffic is routed via the backup ISDN interface.

```

Router> enable
Router# configure terminal
Enter configuration commands, one per line.  End with CNTL/Z.

Router(config)# interface ethernet0/0
Router(config-if)# ipv6 address 2001:0DB8:17:1234/64
Router(config-if)# exit

Router(config)# interface Serial2/0
Router(config-if)# ipv6 address 2001:0DB8:1:1234/64
Router(config-if)# ipv6 router isis
Router(config-if)# exit

Router(config)# router isis
Router(config-router)# net 42.0000.0000.0000.0001.00
Router(config-router)# exit

Router(config)# interface BRI1/0
Router(config-if)# encapsulation ppp
Router(config-if)# ipv6 enable
Router(config-if)# isdn switch-type basic-net3
Router(config-if)# ppp authentication chap optional
Router(config-if)# ppp multilink
Router(config-if)# exit

Router(config)# dialer-list 1 protocol ipv6 permit
Router(config)# ipv6 route 2001:0DB8:1::/32 BRI1/0 200
Router(config)# end
Router#
00:03:07: %SYS-5-CONFIG_I: Configured from console by console

```

Configuration Examples Using the show ipv6 static, show ipv6 route, and debug ipv6 routing Commands

The following examples show the various forms and output for the **show ipv6 static** and the **debug ipv6 routing** commands. The following examples are included:

- [Sample Output from the show ipv6 static Command when No Options Are Specified in the Command Syntax, page 499](#)

- [Sample Output from the show ipv6 static Command with the IPv6 Address and Prefix Command, page 499](#)
- [Sample Output from the show ipv6 static interface Command, page 500](#)
- [Sample Output from the show ipv6 static recursive Command, page 500](#)
- [Sample Output from the show ipv6 static detail Command, page 500](#)
- [Sample Output from the show ipv6 route Command, page 500](#)
- [Sample Output for the debug ipv6 routing Command, page 501](#)

Sample Output from the show ipv6 static Command when No Options Are Specified in the Command Syntax

When no options are specified in the command, those routes installed in the IPv6 routing table are marked with an asterisk, as shown in the following example:

```
Router# show ipv6 static

IPv6 Static routes
Code: * - installed in RIB
* 2001:0DB8:3000:0/16, interface Ethernet1/0, distance 1
* 2001:0DB8:4000:0/16, via nexthop 2001:0DB8:1:1, distance 1
  2001:0DB8:5000:0/16, interface Ethernet3/0, distance 1
* 2001:0DB8:5555:0/16, via nexthop 2001:0DB8:4000:1, distance 1
  2001:0DB8:5555:0/16, via nexthop 2001:0DB8:9999:1, distance 1
* 2001:0DB8:5555:0/16, interface Ethernet2/0, distance 1
* 2001:0DB8:6000:0/16, via nexthop 2001:0DB8:2007:1, interface Ethernet1/0, distance 1
```

[Table 34](#) describes the significant fields shown in the display.

Table 34 *show ipv6 static Field Descriptions*

Field	Description
4000:0/16	Indicates the IPv6 prefix of the remote network.
via nexthop 2001:0DB8:1:1	Specifies the address of the next router in the path to the remote network.
interface Ethernet1/0	When an interface is specified, only those static routes with the specified interface as outgoing interface are displayed.
distance <i>n</i>	Indicates the administrative distance to the specified route.

Sample Output from the show ipv6 static Command with the IPv6 Address and Prefix Command

When the *ipv6-address* or *ipv6-prefix/prefix-length* argument is specified, only information about static routes for that address or network is displayed. The following is sample output from the **show ipv6 static** command when entered with the IPv6 prefix 2001:0DB8:200::/35:

```
Router# show ipv6 static 2001:0DB8:5555:0/16

IPv6 Static routes
Code: * - installed in RIB
* 2001:0DB8:5555:0/16, via nexthop 2001:0DB8:4000:1, distance 1
  2001:0DB8:5555:0/16, via nexthop 2001:9999:1, distance 2
* 2001:0DB8:5555:0/16, interface Ethernet2/0, distance 1
```

Sample Output from the show ipv6 static interface Command

When an interface is supplied, only those static routes with the specified interface as outgoing interface are displayed. The **interface** keyword may be used with or without the IPv6 address and prefix specified in the **show ipv6 static** command.

```
Router# show ipv6 static interface ethernet3/0

IPv6 Static routes
Code: * - installed in RIB
      2001:0DB8:5000:)/16, interface Ethernet3/0, distance 1
```

Sample Output from the show ipv6 static recursive Command

When the **recursive** keyword is specified in the **show ipv6 static** command, only recursive static routes are displayed. The **recursive** keyword is mutually exclusive with the **interface** keyword, but it may be used *with* or *without* the IPv6 prefix included in the command syntax.

```
Router# show ipv6 static recursive

IPv6 Static routes
Code: * - installed in RIB
      * 2001:0DB8:4000:0/16, via nexthop 2001:0DB8:1:1, distance 1
      * 2001:0DB8:5555:0/16, via nexthop 2001:0DB8:4000:1, distance 2
      2001:0DB8:5555:0/16, via nexthop 2001:0DB8:9999:1, distance 3
```

Sample Output from the show ipv6 static detail Command

When the **detail** keyword is specified, the following additional information is also displayed:

- For *valid* recursive routes, the output path set, and maximum resolution depth
- For *invalid* recursive routes, the reason why the route is not valid.
- For *invalid* direct or fully-specified routes, the reason why the route is not valid.

```
Router# show ipv6 static detail

IPv6 Static routes
Code: * - installed in RIB
      * 2001:0DB8:3000:0/16, interface Ethernet1/0, distance 1
      * 2001:0DB8:4000:0/16, via nexthop 2001:0DB8:2001:1, distance 1
        Resolves to 1 paths (max depth 1)
        via Ethernet1/0
      2001:0DB8:5000:0/16, interface Ethernet3/0, distance 1
        Interface is down
      * 2001:0DB8:5555:0/16, via nexthop 2001:0DB8:4000:1, distance 1
        Resolves to 1 paths (max depth 2)
        via Ethernet1/0
      2001:0DB8:5555:0/16, via nexthop 2001:0DB8:9999:1, distance 1
        Route does not fully resolve
      * 2001:0DB8:5555:0/16, interface Ethernet2/0, distance 1
      * 2001:0DB8:6000:0/16, via nexthop 2001:0DB8:2007:1, interface Ethernet1/0, distance 1
```

Sample Output from the show ipv6 route Command

In the following example, the **show ipv6 route** command is used to verify the configuration of a static route through a point-to-point interface:

```
Router# show ipv6 route
```

```
IPv6 Routing Table - 9 entries
Codes: C - Connected, L - Local, S - Static, R - RIP, B - BGP
       U - Per-user Static route
       I1 - ISIS L1, I2 - ISIS L2, IA - ISIS interarea
       O - OSPF intra, OI - OSPF inter, OE1 - OSPF ext 1, OE2 - OSPF ext 2
S    2001:0DB8::/32 [1/0]
    via ::, Serial2/0
```

In the following example, the **show ipv6 route** command is used to verify the configuration of a static route on a multiaccess interface. An IPv6 link-local address—FE80::1—is the next hop router.

```
Router# show ipv6 route

IPv6 Routing Table - 11 entries
Codes: C - Connected, L - Local, S - Static, R - RIP, B - BGP
       U - Per-user Static route
       I1 - ISIS L1, I2 - ISIS L2, IA - ISIS interarea
       O - OSPF intra, OI - OSPF inter, OE1 - OSPF ext 1, OE2 - OSPF ext 2
S    2001:0DB8::/32 [1/0]
    via FE80::1, Ethernet0/0
```

To display all static routes in the IPv6 routing table, use the **show ipv6 route static** command is used with **static** as the value of the protocol argument:

```
Router# show ipv6 route static

IPv6 Routing Table - 330 entries
Codes: C - Connected, L - Local, S - Static, R - RIP, B - BGP
       U - Per-user Static route
       I1 - ISIS L1, I2 - ISIS L2, IA - ISIS interarea
S    2001:0DB8::/32 [1/0]
    via ::, Tunnel0
S    3FFE:C00:8011::/48 [1/0]
    via ::, Null0
S    ::/0 [254/0]
    via 2001:0DB8:2002:806B, Null
```

Sample Output for the debug ipv6 routing Command

In the following example, the **debug ipv6 routing** command is used to verify the installation of a floating static route into the IPv6 routing table when an IPv6 RIP route is deleted. The floating static IPv6 route was previously configured with an administrative distance value of 130. The backup route was added as a floating static route because RIP routes have a default administrative distance of 120, and the RIP route should be the preferred route. When the RIP route is deleted, the floating static route is installed in the IPv6 routing table.

```
Router# debug ipv6 routing

*Oct 10 18:28:00.847: IPv6RT0: rip two, Delete 2001:0DB8::/32 from table
*Oct 10 18:28:00.847: IPv6RT0: static, Backup call for 2001:0DB8::/32
*Oct 10 18:28:00.847: IPv6RT0: static, Add 2001:0DB8::/32 to table
*Oct 10 18:28:00.847: IPv6RT0: static, Adding next-hop :: over Serial2/0 for
2001:0DB8::/32, [130/0]
```

Where to Go Next

If you want to implement routing protocols, refer to the *Implementing RIP for IPv6*, *Implementing IS-IS for IPv6*, *Implementing OSPF for IPv6*, or *Implementing Multiprotocol BGP for IPv6* module.

Additional References

For additional information related to configuring static IPv6 routes, see the following sections.

Related Documents

Related Topic	Document Title
IP static route configuration	“Configuring IP Routing Protocol-Independent Features” chapter in the <i>Cisco IOS IP Configuration Guide</i> , Release 12.4
IP static route commands: complete command syntax, command mode, defaults, usage guidelines, and examples	<i>Cisco IOS IP Command Reference, Volume 2 of 3: Routing Protocols</i> , Release 12.4
IPv6 supported feature list	<i>Start Here: Cisco IOS Software Release Specifics for IPv6 Features</i>
IPv6 commands: complete command syntax, command mode, defaults, usage guidelines, and examples	<i>IPv6 for Cisco IOS Command Reference</i>
IPv4 configuration and command reference information	http://www.cisco.com/univercd/cc/td/doc/product/software/ios123/123cgcr/index.htm

Standards

Standards	Title
No new or modified standards are supported by this feature, and support for existing standards has not been modified by this feature.	—

MIBs

MIBs	MIBs Link
No new or modified MIBs are supported by this feature, and support for existing MIBs has not been modified by this feature.	To locate and download MIBs for selected platforms, Cisco IOS releases, and feature sets, use Cisco MIB Locator found at the following URL: http://www.cisco.com/go/mibs

RFCs

RFCs	Title
No new or modified RFCs are supported by this feature, and support for existing RFCs has not been modified by this feature.	—

Technical Assistance

Description	Link
The Cisco Technical Support website contains thousands of pages of searchable technical content, including links to products, technologies, solutions, technical tips, and tools. Registered Cisco.com users can log in from this page to access even more content.	http://www.cisco.com/techsupport



Implementing Traffic Filters and Firewalls for IPv6 Security

The *Implementing Traffic Filters and Firewalls for IPv6 Security* module describes how to configure Cisco IOS IPv6 traffic filter and firewall features for your Cisco networking devices. These security features can protect your network against degradation or failure and also against data loss or compromise resulting from intentional attacks and from unintended but damaging mistakes by well-meaning network users.

Finding Support Information for Platforms and Cisco IOS Software Images

Use Cisco Feature Navigator to find information about platform support and Cisco IOS software image support. Access Cisco Feature Navigator at <http://www.cisco.com/go/fn>. You must have an account on Cisco.com. If you do not have an account or have forgotten your username or password, click **Cancel** at the login dialog box and follow the instructions that appear.

Contents

- [Prerequisites for Implementing Traffic Filters and Firewalls for IPv6 Security, page 505](#)
- [Information About Implementing Traffic Filters and Firewalls for IPv6 Security, page 506](#)
- [How to Implement Traffic Filters and Firewalls for IPv6 Security, page 508](#)
- [Configuration Examples for Implementing Traffic Filters and Firewalls for IPv6 Security, page 530](#)
- [Additional References, page 533](#)

Prerequisites for Implementing Traffic Filters and Firewalls for IPv6 Security

- You should be familiar with IPv4. Refer to the publications referenced in the “[Related Documents](#)” section for IPv4 configuration and command reference information.
- You should be familiar with IPv6 addressing and basic configuration. Refer to the *Implementing Basic Connectivity for IPv6* module for more information.

[Table 35](#) identifies the earliest release for each early-deployment train in which the feature became available.

Table 35 Minimum Required Cisco IOS Release

Feature	Minimum Required Cisco IOS Release by Release Train
Standard access control lists	12.2(2)T, 12.0(21)ST, 12.0(22)S, 12.2(14)S, 12.3, 12.3(2)T, 12.4, 12.4(2)T, 12.2(28)SB, 12.2(33)SRA
Extended ACLs ¹	12.0(23)S, 12.2(13)T, 12.2(14)S, 12.3, 12.3(2)T, 12.4, 12.4(2)T, 12.2(28)SB, 12.2(33)SRA
IPv6 IOS Firewall	12.3(7)T, 12.4, 12.4(2)T
IPv6 FTP Firewall inspection	12.3(11)T, 12.4, 12.4(2)T
IPv6 ACL enhancements	12.4(2)T

1. IPv6 extended access control lists and IPv6 provider edge router over Multiprotocol Label Switching (MPLS) are implemented with hardware acceleration on the Cisco 12000 series Internet router IP service engineer (ISE) line cards in Cisco IOS routers in Cisco IOS Release 12.0(25)S and later releases.

Information About Implementing Traffic Filters and Firewalls for IPv6 Security

To implement security features for IPv6, you need to understand the following concepts:

- [Access Control Lists for IPv6 Traffic Filtering, page 506](#)
- [Cisco IOS Firewall for IPv6, page 506](#)

Access Control Lists for IPv6 Traffic Filtering

Cisco IOS Release 12.2(2)T through Cisco IOS Release 12.2(13)T and Cisco IOS Release 12.0(21)ST and later releases support only standard IPv6 ACL functionality. This functionality is similar to standard ACLs in IPv4. Access lists determine what traffic is blocked and what traffic is forwarded at router interfaces and allow filtering based on source and destination addresses, inbound and outbound to a specific interface. Each access list has an implicit deny statement at the end. IPv6 ACLs are defined and their deny and permit conditions are set using the **ipv6 access-list** command with the **deny** and **permit** keywords in global configuration mode.

In Cisco IOS Release 12.0(23)S and 12.2(13)T or later releases, the standard IPv6 ACL functionality is extended to support traffic filtering based on IPv6 option headers and optional, upper-layer protocol type information for finer granularity of control (functionality similar to extended ACLs in IPv4).

Cisco IOS Firewall for IPv6

Cisco IOS Firewall is a feature that provides advanced traffic filtering functionality as an integral part of a network's firewall. Cisco IOS Firewall for IPv6 enables you to implement Cisco IOS Firewall in IPv6 networks. Cisco IOS Firewall coexists with Cisco IOS Firewall for IPv4 networks and is supported on all dual-stack routers.

Cisco IOS Firewall for IPv6 includes the following features:

- Fragmented packet inspection—The fragment header is used to trigger fragment processing. Cisco IOS Firewall virtual fragment reassembly (VFR) examines out-of-sequence fragments and switches the packets into correct order, examines the number of fragments from a single IP given a unique identifier (Denial of Service [DoS] attack), and performs virtual reassembly to hand off packets to upper-layer protocols.
- IPv6 DoS attack mitigation—Mitigation mechanisms have been implemented in the same fashion as for IPv4 implementation, including SYN half-open connections.
- Tunneled packet inspection—Tunneled IPv6 packets terminated at a Cisco IOS firewall router can be inspected by the Cisco IOS Firewall for IPv6.
- Stateful packet inspection—Stateful packet inspection of TCP, User Datagram Protocol (UDP), Internet Control Message Protocol version 6 (ICMPv6), and FTP sessions.
- Stateful inspection of packets originating from the IPv4 network and terminating in an IPv6 environment—This feature uses IPv4-to-IPv6 translation services.
- Interpretation or recognition of most IPv6 Extension Header information—IPv6 Extension Header information including routing header, hop-by-hop Options header, and fragment header is interpreted or recognized.
- Port-to-application mapping (PAM)—Cisco IOS Firewall for IPv6 includes PAM.

PAM in Cisco IOS Firewall for IPv6

PAM allows you to customize TCP or UDP port numbers for network services or applications. PAM uses this information to support network environments that run services using ports that are different from the registered or well-known ports associated with an application.

Using the port information, PAM establishes a table of default port-to-application mapping information at the firewall. The information in the PAM table enables Context-based Access Control (CBAC) supported services to run on nonstandard ports. CBAC was limited to inspecting traffic using only the well-known or registered ports associated with an application, whereas PAM allows network administrators to customize network access control for specific applications and services.

PAM also supports host or subnet specific port mapping, which allows you to apply PAM to a single host or subnet using standard ACLs. Host or subnet specific port mapping is done using standard ACLs.

Cisco IOS Firewall Alerts, Audit Trails, and System Logging

Cisco IOS Firewall generates real-time alerts and audit trails based on events tracked by the firewall. Enhanced audit trail features use system logging to track all network transactions; to record time stamps, source host, destination host, and ports used; and to record the total number of transmitted bytes for advanced, session-based reporting. Real-time alerts send system logging error messages to central management consoles when the system detects suspicious activity. Using Cisco IOS Firewall inspection rules, you can configure alerts and audit trail information on a per-application protocol basis. For example, if you want to generate audit trail information for TCP traffic, you can specify the generation of this information in the Cisco IOS Firewall rule that defines TCP inspection.

The Cisco IOS Firewall provides audit trail messages to record details about inspected sessions. Audit trail information is configurable on a per-application basis using the CBAC inspection rules. To determine which protocol was inspected, use the port number associated with the responder. The port number appears immediately after the address.

IPv6 Packet Inspection

The following header fields are all used for IPv6 inspection—traffic class, flow label, payload length, next header, hop limit, and source or destination address. For further information on and descriptions of the IPv6 header fields, see RFC 2474.

Tunneling Support

IPv6 packets tunneled in IPv4 are not inspected. If a tunnel terminates on a router, and IPv6 traffic exiting the tunnel is nonterminating, then the traffic is inspected.

Virtual Fragment Reassembly

When VFR is enabled, VFR processing begins after ACL input lists are checked against incoming packets. The incoming packets are tagged with the appropriate VFR information.

Cisco IOS Firewall Restrictions

Cisco IOS Intrusion Detection System (IDS) is not supported for IPv6.

How to Implement Traffic Filters and Firewalls for IPv6 Security

The tasks in the following sections explain how to configure security features for IPv6:

- [Configuring IPv6 Traffic Filtering, page 508](#)
- [Controlling Access to a vty, page 514](#)
- [Configuring Cisco IOS Firewall for IPv6, page 517](#)
- [Verifying IPv6 Security Configuration and Operation, page 523](#)
- [Troubleshooting IPv6 Security Configuration and Operation, page 525](#)

Configuring IPv6 Traffic Filtering

To enable IPv6 traffic filtering, you must perform the following steps:

1. Create an IPv6 ACL
2. Configure the IPv6 ACL to pass or block traffic
3. Apply the IPv6 ACL to an interface

If you are running Cisco IOS Release 12.2(13)T, 12.0(23)S or later releases, proceed to the [“Creating and Configuring an IPv6 ACL for Traffic Filtering”](#) section. If you are running Cisco IOS Release 12.2(11)T, 12.0(22)S, 12.0(21)ST or earlier releases, proceed to the [“Creating an IPv6 ACL for Traffic Filtering for Older Releases”](#) section.

Restrictions

IPv6 ACLs are defined by a unique name (IPv6 does not support numbered ACLs). An IPv4 ACL and an IPv6 ACL cannot share the same name.

Creating and Configuring an IPv6 ACL for Traffic Filtering

This part describes how to configure your networking devices to filter traffic, function as a firewall, or detect potential viruses. The following task explains how to create an IPv6 ACL and configure the IPv6 ACL to filter traffic in Cisco IOS Release 12.2(13)T and 12.0(23)S or later releases.

Prerequisites

In Cisco IOS Release 12.2(13)T and 12.0(23)S or later releases, for backward compatibility, the **ipv6 access-list** command with the **deny** and **permit** keywords in global configuration mode is still supported; however, an IPv6 ACL defined with deny and permit conditions in global configuration mode is translated to IPv6 access list configuration mode. See the [“Create and Apply IPv6 ACL: Examples”](#) section for an example of a translated IPv6 ACL configuration.

Restrictions

- Each IPv6 ACL contains implicit permit rules to enable IPv6 neighbor discovery. These rules can be overridden by the user by placing a **deny ipv6** any any statement within an ACL. The IPv6 neighbor discovery process makes use of the IPv6 network layer service; therefore, by default, IPv6 ACLs implicitly allow IPv6 neighbor discovery packets to be sent and received on an interface. In IPv4, the Address Resolution Protocol (ARP), which is equivalent to the IPv6 neighbor discovery process, makes use of a separate data link layer protocol; therefore, by default, IPv4 ACLs implicitly allow ARP packets to be sent and received on an interface.
- Time-based and reflexive ACLs are not supported for IPv4 or IPv6 on the Cisco 12000 series platform. The **reflect**, **timeout**, and **time-range** keywords of the **permit** command in IPv6 are excluded on the Cisco 12000 series.

SUMMARY STEPS

1. **enable**
2. **configure terminal**
3. **ipv6 access-list** *access-list-name*
4. **permit** *protocol* { *source-ipv6-prefix/prefix-length* | **any** | **host** *source-ipv6-address* } [*operator* [*port-number*]] { *destination-ipv6-prefix/prefix-length* | **any** | **host** *destination-ipv6-address* } [*operator* [*port-number*]] [**dest-option-type** [*doh-number* | *doh-type*]] [**dscp** *value*] [**flow-label** *value*] [**fragments**] [**log**] [**log-input**] [**mobility**] [**mobility-type** [*mh-number* | *mh-type*]] [**reflect** *name*] [**timeout** *value*]] [**routing**] [**routing-type** *routing-number*] [**sequence** *value*] [**time-range** *name*]
or
deny *protocol* { *source-ipv6-prefix/prefix-length* | **any** | **host** *source-ipv6-address* } [*operator* [*port-number*]] { *destination-ipv6-prefix/prefix-length* | **any** | **host** *destination-ipv6-address* } [*operator* [*port-number*]] [**dest-option-type** [*doh-number* | *doh-type*]] [**dscp** *value*] [**flow-label** *value*] [**fragments**] [**log**] [**log-input**] [**mobility**] [**mobility-type** [*mh-number* | *mh-type*]] [**routing**] [**routing-type** *routing-number*] [**sequence** *value*] [**time-range** *name*] [**undetermined-transport**]

DETAILED STEPS

	Command or Action	Purpose
Step 1	<p>enable</p> <p>Example: Router> enable</p>	<p>Enables privileged EXEC mode.</p> <ul style="list-style-type: none"> Enter your password if prompted.
Step 2	<p>configure terminal</p> <p>Example: Router# configure terminal</p>	<p>Enters global configuration mode.</p>
Step 3	<p>ipv6 access-list <i>access-list-name</i></p> <p>Example: Router(config)# ipv6 access-list outbound</p>	<p>Defines an IPv6 ACL and enters IPv6 access list configuration mode. The router prompt changes to Router(config-ipv6-acl)#.</p> <ul style="list-style-type: none"> The <i>access-list name</i> argument specifies the name of the IPv6 ACL. IPv6 ACL names cannot contain a space or quotation mark, or begin with a numeral.
Step 4	<p>permit <i>protocol</i> { <i>source-ipv6-prefix/prefix-length</i> any host <i>source-ipv6-address</i> } [operator [port-number]] { <i>destination-ipv6-prefix/prefix-length</i> any host <i>destination-ipv6-address</i> } [operator [port-number]] [dest-option-type [doh-number doh-type]] [dscp value] [flow-label value] [fragments] [log] [log-input] [mobility] [mobility-type [mh-number mh-type]] [reflect name [timeout value]] [routing] [routing-type routing-number] [sequence value] [time-range name]</p> <p>OR</p> <p>deny <i>protocol</i> { <i>source-ipv6-prefix/prefix-length</i> any host <i>source-ipv6-address</i> } [operator [port-number]] { <i>destination-ipv6-prefix/prefix-length</i> any host <i>destination-ipv6-address</i> } [operator [port-number]] [dest-option-type [doh-number doh-type]] [dscp value] [flow-label value] [fragments] [log] [log-input] [mobility] [mobility-type [mh-number mh-type]] [routing] [routing-type routing-number] [sequence value] [time-range name] [undetermined-transport]</p> <p>Example: Router(config-ipv6-acl)# permit tcp 2001:0DB8:0300:0201::/32 eq telnet any reflect reflectout</p> <p>Example: Router(config-ipv6-acl)# deny tcp host 2001:0db8:1::1 any log-input</p>	<p>Specifies permit or deny conditions for an IPv6 ACL.</p> <ul style="list-style-type: none"> The <i>protocol</i> argument specifies the name or number of an Internet protocol. It can be one of the keywords ahp, esp, icmp, ipv6, pcp, setp, tcp, or udp, or an integer in the range from 0 to 255 representing an IPv6 protocol number. The <i>source-ipv6-prefix/prefix-length</i> and <i>destination-ipv6-prefix/prefix-length</i> arguments specify the source and destination IPv6 network or class of networks about which to set permit conditions. These arguments must be in the form documented in RFC 2373 where the address is specified in hexadecimal using 16-bit values between colons. The any keyword is an abbreviation for the IPv6 prefix <code>::/0</code>. The host <i>source-ipv6-address</i> keyword and argument specify the source IPv6 host address about which to set permit conditions. The <i>source-ipv6-address</i> argument must be in the form documented in RFC 2373 where the address is specified in hexadecimal using 16-bit values between colons. Refer to the permit and deny commands in the <i>IPv6 for Cisco IOS Command Reference</i> document for information on supported arguments and keywords.

Applying the IPv6 ACL to an Interface

This task describes how to apply the IPv6 ACL to an interface in Cisco IOS Release 12.2(13)T and 12.0(23)S or later releases.

SUMMARY STEPS

1. **enable**
2. **configure terminal**
3. **interface** *type number*
4. **ipv6 traffic-filter** *access-list-name* {**in** | **out**}

DETAILED STEPS

	Command or Action	Purpose
Step 1	enable Example: Router> enable	Enables privileged EXEC mode. <ul style="list-style-type: none"> • Enter your password if prompted.
Step 2	configure terminal Example: Router# configure terminal	Enters global configuration mode.
Step 3	interface <i>type number</i> Example: Router(config)# interface ethernet 0	Specifies the interface type and number, and enters interface configuration mode.
Step 4	ipv6 traffic-filter <i>access-list-name</i> { in out } Example: Router(config-if)# ipv6 traffic-filter outbound out	Applies the specified IPv6 access list to the interface specified in the previous step. <ul style="list-style-type: none"> • The in keyword filters incoming IPv6 traffic on the specified interface. • The out keyword filters outgoing IPv6 traffic on the specified interface.

What to Do Next

To secure vty access to the router, proceed to the [“Controlling Access to a vty”](#) section.

Creating an IPv6 ACL for Traffic Filtering for Older Releases

This task explains how to create an IPv6 ACL and configure the IPv6 ACL to pass or block traffic in Cisco IOS Release 12.2(11)T, 12.0(22)S, 12.0(21)ST, or earlier releases.

Restrictions

- The *source-ipv6-prefix* argument filters traffic by packet source address, and the *destination-ipv6-prefix* argument filters traffic by packet destination address.
- The Cisco IOS software compares an IPv6 prefix against the **permit** and **deny** condition statements in the access list. Every IPv6 access list, including access lists that do not have any permit and deny condition statements, has an implicit **deny any any** statement as its last match condition. The priority or sequence value applied to each condition statement dictates the order in which the statement is applied in the access list.

SUMMARY STEPS

1. **enable**
2. **configure terminal**
3. **ipv6 access-list** *access-list-name* {**permit** | **deny**} {*source-ipv6-prefix*/*prefix-length* | **any**} {*destination-ipv6-prefix*/*prefix-length* | **any**} [**priority value**]

DETAILED STEPS

	Command or Action	Purpose
Step 1	<p>enable</p> <p>Example: Router> enable</p>	<p>Enables privileged EXEC mode.</p> <ul style="list-style-type: none"> Enter your password if prompted.
Step 2	<p>configure terminal</p> <p>Example: Router# configure terminal</p>	<p>Enters global configuration mode.</p>
Step 3	<p>ipv6 access-list <i>access-list-name</i> {permit deny} {<i>source-ipv6-prefix/prefix-length</i> any} {<i>destination-ipv6-prefix/prefix-length</i> any} [priority <i>value</i>]</p> <p>Example: Router(config)# ipv6 access-list list2 deny fec0:0:0:2::/64 any</p>	<p>Defines an IPv6 ACL and sets deny or permit conditions for the ACL.</p> <ul style="list-style-type: none"> The <i>access-list name</i> argument specifies the name of the IPv6 ACL. IPv6 ACL names cannot contain a space or quotation mark, or begin with a numeral. The deny keyword specifies deny conditions for the access list. The permit keyword specifies permit conditions for the access list. The <i>prefix-length</i> argument indicates the number of consecutive, most significant bits that are used in the match. A slash mark must precede the decimal value. The any keyword, when specified instead of the <i>source-ipv6-prefix/prefix-length</i> or <i>destination-ipv6-prefix/prefix-length</i> argument, matches any prefix and is equivalent to the IPv6 prefix <code>::/0</code>. The priority keyword specifies the order in which the statement is applied in the access list. The acceptable range is from 1 to 4294967295.

Applying the IPv6 ACL to an Interface in Older Releases

This task describes how to apply the IPv6 ACL to an interface in Cisco IOS Release 12.2(11)T, 12.0(22)S, 12.0(21)ST, or earlier releases.

SUMMARY STEPS

- enable**
- configure terminal**
- interface** *type number*
- ipv6 traffic-filter** *access-list-name* {**in** | **out**}

DETAILED STEPS

	Command or Action	Purpose
Step 1	enable Example: Router> enable	Enables privileged EXEC mode. <ul style="list-style-type: none"> Enter your password if prompted.
Step 2	configure terminal Example: Router# configure terminal	Enters global configuration mode.
Step 3	interface <i>type number</i> Example: Router(config)# interface ethernet 0	Specifies the interface type and number, and enters interface configuration mode.
Step 4	ipv6 traffic-filter <i>access-list-name {in out}</i> Example: Router(config-if)# ipv6 traffic-filter list2 out	Applies the specified IPv6 access list to the interface specified in the previous step. <ul style="list-style-type: none"> The in keyword filters incoming IPv6 traffic on the specified interface. The out keyword filters outgoing IPv6 traffic on the specified interface.

Controlling Access to a vty

The following two tasks explain how to restrict access to a vty on a router.

- [Creating an IPv6 ACL for Access Class Filtering, page 514](#)
- [Applying an IPv6 ACL to the Virtual Terminal Line, page 516](#)

Access Class Filtering in IPv6

Filtering incoming and outgoing connections to and from the router based on an IPv6 ACL is performed using the **ipv6 access-class** command in line configuration mode. The **ipv6 access-class** command is similar to the **access-class** command, except the IPv6 ACLs are defined by a name. If the IPv6 ACL is applied to inbound traffic, the source address in the ACL is matched against the incoming connection source address and the destination address in the ACL is matched against the local router address on the interface. If the IPv6 ACL is applied to outbound traffic, the source address in the ACL is matched against the local router address on the interface and the destination address in the ACL is matched against the outgoing connection source address. We recommend that identical restrictions are set on all the virtual terminal lines because a user can attempt to connect to any of them.

Creating an IPv6 ACL for Access Class Filtering

The following task explains how to control access to a vty on a router by creating an IPv6 ACL to provide access class filtering.

SUMMARY STEPS

1. **enable**
2. **configure terminal**
3. **ipv6 access-list** *access-list-name*
4. **permit** *protocol* { *source-ipv6-prefix/prefix-length* | **any** | **host** *source-ipv6-address* } [*operator* [*port-number*]] { *destination-ipv6-prefix/prefix-length* | **any** | **host** *destination-ipv6-address* } [*operator* [*port-number*]] [**dest-option-type** [*doh-number* | *doh-type*]] [**dscp** *value*] [**flow-label** *value*] [**fragments**] [**log**] [**log-input**] [**mobility**] [**mobility-type** [*mh-number* | *mh-type*]] [**reflect** *name*] [**timeout** *value*]] [**routing**] [**routing-type** *routing-number*] [**sequence** *value*] [**time-range** *name*]
 or
deny *protocol* { *source-ipv6-prefix/prefix-length* | **any** | **host** *source-ipv6-address* } [*operator* [*port-number*]] { *destination-ipv6-prefix/prefix-length* | **any** | **host** *destination-ipv6-address* } [*operator* [*port-number*]] [**dest-option-type** [*doh-number* | *doh-type*]] [**dscp** *value*] [**flow-label** *value*] [**fragments**] [**log**] [**log-input**] [**mobility**] [**mobility-type** [*mh-number* | *mh-type*]] [**routing**] [**routing-type** *routing-number*] [**sequence** *value*] [**time-range** *name*] [**undetermined-transport**]

DETAILED STEPS

	Command or Action	Purpose
Step 1	enable Example: Router> enable	Enables privileged EXEC mode. • Enter your password if prompted.
Step 2	configure terminal Example: Router# configure terminal	Enters global configuration mode.

Command or Action	Purpose
<p>Step 3</p> <pre>ipv6 access-list access-list-name</pre> <p>Example: Router(config)# ipv6 access-list cisco</p>	<p>Defines an IPv6 ACL and enters IPv6 access list configuration mode. The router prompt changes to Router(config-ipv6-acl)#.</p> <ul style="list-style-type: none"> The <i>access-list name</i> argument specifies the name of the IPv6 ACL. IPv6 ACL names cannot contain a space or quotation mark, or begin with a numeral.
<p>Step 4</p> <pre>permit protocol {source-ipv6-prefix/prefix-length any host source-ipv6-address} [operator [port-number]] {destination-ipv6-prefix/prefix-length any host destination-ipv6-address} [operator [port-number]] [dest-option-type [doh-number doh-type]] [dscp value] [flow-label value] [fragments] [log] [log-input] [mobility] [mobility-type [mh-number mh-type]] [reflect name [timeout value]] [routing] [routing-type routing-number] [sequence value] [time-range name]</pre> <p>or</p> <pre>deny protocol {source-ipv6-prefix/prefix-length any host source-ipv6-address} [operator [port-number]] {destination-ipv6-prefix/prefix-length any host destination-ipv6-address} [operator [port-number]] [dest-option-type [doh-number doh-type]] [dscp value] [flow-label value] [fragments] [log] [log-input] [mobility] [mobility-type [mh-number mh-type]] [routing] [routing-type routing-number] [sequence value] [time-range name] [undetermined-transport]</pre> <p>Example: Router(config-ipv6-acl)# permit ipv6 host 2001:0DB8:0:4::32 any eq telnet</p> <p>or</p> <p>Example: Router(config-ipv6-acl)# deny ipv6 host 2001:0DB8:0:6::6/32 any</p>	<p>Specifies permit or deny conditions for an IPv6 ACL.</p> <ul style="list-style-type: none"> The <i>protocol</i> argument specifies the name or number of an Internet protocol. For an access class match against the IPv6 ACL the argument must be either the ipv6 or the tcp keyword. If TCP ports are specified within the ACL, the port ranges must include the ports used to gain access. For incoming connections, for example, the destination port must include the Telnet port. The <i>source-ipv6-prefix/prefix-length</i> and <i>destination-ipv6-prefix/prefix-length</i> arguments specify the source and destination IPv6 network or class of networks about which to set permit conditions. These arguments must be in the form documented in RFC 2373 where the address is specified in hexadecimal using 16-bit values between colons. The any keyword is an abbreviation for the IPv6 prefix ::/0. The host source-ipv6-address keyword and argument specify the source IPv6 host address about which to set permit conditions. The <i>source-ipv6-address</i> argument must be in the form documented in RFC 2373 where the address is specified in hexadecimal using 16-bit values between colons. Refer to the permit and deny commands in the <i>IPv6 for Cisco IOS Command Reference</i> document for information on supported arguments and keywords.

Applying an IPv6 ACL to the Virtual Terminal Line

After you have created the IPv6 ACL for access class filtering, you must apply it to a specified virtual terminal line. The following task describes how to apply the ACL to the virtual terminal line.

SUMMARY STEPS

1. **enable**
2. **configure terminal**

3. **line** [aux | console | tty | vty] *line-number* [*ending-line-number*]
4. **ipv6 access-class** *ipv6-access-list-name* {in | out}

DETAILED STEPS

	Command or Action	Purpose
Step 1	enable Example: Router> enable	Enables privileged EXEC mode. <ul style="list-style-type: none"> • Enter your password if prompted.
Step 2	configure terminal Example: Router# configure terminal	Enters global configuration mode.
Step 3	line [aux console tty vty] <i>line-number</i> [<i>ending-line-number</i>] Example: Router(config)# line vty 0 4	Identifies a specific line for configuration and enters line configuration mode. <ul style="list-style-type: none"> • In this example, the vty keyword is used to specify the virtual terminal lines for remote console access.
Step 4	ipv6 access-class <i>ipv6-access-list-name</i> {in out} Example: Router(config-line)# ipv6 access-class cisco in	Filters incoming and outgoing connections to and from the router based on an IPv6 ACL. <ul style="list-style-type: none"> • The <i>ipv6-access-list name</i> argument specifies the name of the IPv6 ACL. IPv6 ACL names cannot contain a space or quotation mark, or begin with a numeral. • If the in keyword is used, the source address in the ACL is matched against the incoming connection source address and the destination address in the ACL is matched against the local router address on the interface. • If the out keyword is used, the source address in the ACL is matched against the local router address on the interface and the destination address in the ACL is matched against the outgoing connection source address.

Configuring Cisco IOS Firewall for IPv6

This task shows how to configure the Cisco IOS Firewall for IPv6 environments. This configuration scenario uses both packet inspection and ACLs.

SUMMARY STEPS

1. **enable**
2. **configure terminal**
3. **ipv6 unicast-routing**

4. **ipv6 inspect name** *inspection-name protocol* [**alert** {on | off}] [**audit-trail** {on | off}] [**timeout** *seconds*]
5. **interface** *type number*
6. **ipv6 address** {*ipv6-address/prefix-length* | *prefix-name sub-bits/prefix-length*}
7. **ipv6 enable**
8. **ipv6 traffic-filter** *access-list-name* {in | out}
9. **ipv6 inspect** *inspect-name*
10. **ipv6 access-list** *access-list-name*
11. **permit** *protocol* {*source-ipv6-prefix/prefix-length* | **any** | **host** *source-ipv6-address*} [*operator* [*port-number*]] {*destination-ipv6-prefix/prefix-length* | **any** | **host** *destination-ipv6-address*} [*operator* [*port-number*]] [**dest-option-type** [*doh-number* | *doh-type*]] [**dscp** *value*] [**flow-label** *value*] [**fragments**] [**log**] [**log-input**] [**mobility**] [**mobility-type** [*mh-number* | *mh-type*]] [**reflect** *name*] [**timeout** *value*] [**routing**] [**routing-type** *routing-number*] [**sequence** *value*] [**time-range** *name*]
or
deny *protocol* {*source-ipv6-prefix/prefix-length* | **any** | **host** *source-ipv6-address*} [*operator* [*port-number*]] {*destination-ipv6-prefix/prefix-length* | **any** | **host** *destination-ipv6-address*} [*operator* [*port-number*]] [**dest-option-type** [*doh-number* | *doh-type*]] [**dscp** *value*] [**flow-label** *value*] [**fragments**] [**log**] [**log-input**] [**mobility**] [**mobility-type** [*mh-number* | *mh-type*]] [**routing**] [**routing-type** *routing-number*] [**sequence** *value*] [**time-range** *name*] [**undetermined-transport**]

DETAILED STEPS

	Command or Action	Purpose
Step 1	enable Example: Router> enable	Enables privileged EXEC mode. <ul style="list-style-type: none">• Enter your password if prompted.
Step 2	configure terminal Example: Router# configure terminal	Enters global configuration mode.
Step 3	ipv6 unicast-routing Example: Router(config)# ipv6 unicast-routing	Enables IPv6 unicast routing.
Step 4	ipv6 inspect name <i>inspection-name protocol</i> [alert {on off}] [audit-trail {on off}] [timeout <i>seconds</i>] Example: Router(config)# ipv6 inspect name ipv6_test icmp timeout 60	Defines a set of IPv6 inspection rules for the firewall.

	Command or Action	Purpose
Step 5	interface <i>type number</i> Example: Router(config)# interface FastEthernet0/0	Specifies the interface on which the inspection will occur.
Step 6	ipv6 address { <i>ipv6-address/prefix-length</i> <i>prefix-name sub-bits/prefix-length</i> } Example: Router(config-if)# ipv6 address 3FFE:C000:0:7::/64 eui-64	Provides the address for the inspection interface.
Step 7	ipv6 enable Example: Router(config-if)# ipv6 enable	Enables IPv6 routing. Note This step is optional if the IPv6 address is specified in step 6.
Step 8	ipv6 traffic-filter <i>access-list-name</i> { in out } Example: Router(config-if)# ipv6 traffic-filter outbound out	Applies the specified IPv6 access list to the interface specified in the previous step. <ul style="list-style-type: none"> • The in keyword filters incoming IPv6 traffic on the specified interface. • The out keyword filters outgoing IPv6 traffic on the specified interface.
Step 9	ipv6 inspect <i>inspection-name</i> { in out } Example: Router(config)#ipv6 inspect ipv6_test in	Applies the set of inspection rules.

Command or Action	Purpose
<p>Step 10 <code>ipv6 access-list access-list-name</code></p> <p>Example: Router(config)# ipv6 access-list outbound</p>	<p>Defines an IPv6 ACL and enters IPv6 access list configuration mode. The router prompt changes to Router(config-ipv6-acl)#.</p> <ul style="list-style-type: none"> The <i>access-list name</i> argument specifies the name of the IPv6 ACL. IPv6 ACL names cannot contain a space or quotation mark, or begin with a numeral.
<p>Step 11 <code>permit protocol</code> {source-ipv6-prefix/prefix-length any host source-ipv6-address} [operator [port-number]] {destination-ipv6-prefix/prefix-length any host destination-ipv6-address} [operator [port-number]] [dest-option-type [doh-number doh-type]] [dscp value] [flow-label value] [fragments] [log] [log-input] [mobility] [mobility-type [mh-number mh-type]] [reflect name [timeout value]] [routing] [routing-type routing-number] [sequence value] [time-range name]</p> <p>or</p> <p><code>deny protocol</code> {source-ipv6-prefix/prefix-length any host source-ipv6-address} [operator [port-number]] {destination-ipv6-prefix/prefix-length any host destination-ipv6-address} [operator [port-number]] [dest-option-type [doh-number doh-type]] [dscp value] [flow-label value] [fragments] [log] [log-input] [mobility] [mobility-type [mh-number mh-type]] [routing] [routing-type routing-number] [sequence value] [time-range name] [undetermined-transport]</p> <p>Example: Router(config-ipv6-acl)# permit tcp 2001:0DB8:0300:0201::/32 any reflect reflectout</p> <p>or</p> <p>Example: Router(config-ipv6-acl)# deny tcp fec0:0:0:0201::/64 any</p>	<p>Specifies permit or deny conditions for an IPv6 ACL.</p> <ul style="list-style-type: none"> The <i>protocol</i> argument specifies the name or number of an Internet protocol. It can be one of the keywords ahp, esp, icmp, ipv6, pcp, sctp, tcp, or udp, or an integer in the range from 0 to 255 representing an IPv6 protocol number. The <i>source-ipv6-prefix/prefix-length</i> and <i>destination-ipv6-prefix/prefix-length</i> arguments specify the source and destination IPv6 network or class of networks about which to set permit conditions. These arguments must be in the form documented in RFC 2373 where the address is specified in hexadecimal using 16-bit values between colons. The any keyword is an abbreviation for the IPv6 prefix ::/0. The host source-ipv6-address keyword and argument specify the source IPv6 host address about which to set permit conditions. The <i>source-ipv6-address</i> argument must be in the form documented in RFC 2373 where the address is specified in hexadecimal using 16-bit values between colons. Refer to the permit and deny commands in the <i>IPv6 for Cisco IOS Command Reference</i> document for information on supported arguments and keywords.

Configuring PAM for IPv6

The tasks in the following sections explain how to configure PAM for IPv6.

- [Creating an IPv6 Access Class Filter for PAM, page 520](#)
- [Applying the IPv6 Access Class Filter to PAM, page 522](#)

Creating an IPv6 Access Class Filter for PAM

The following task explains how to create an IPv6 access class filter to use in PAM configuration:

SUMMARY STEPS

1. **enable**
2. **configure terminal**
3. **ipv6 access-list** *access-list-name*
4. **permit** *protocol* { *source-ipv6-prefix/prefix-length* | **any** | **host** *source-ipv6-address* } [*operator* [*port-number*]] { *destination-ipv6-prefix/prefix-length* | **any** | **host** *destination-ipv6-address* } [*operator* [*port-number*]] [**dest-option-type** [*doh-number* | *doh-type*]] [**dscp** *value*] [**flow-label** *value*] [**fragments**] [**log**] [**log-input**] [**mobility**] [**mobility-type** [*mh-number* | *mh-type*]] [**reflect** *name*] [**timeout** *value*]] [**routing**] [**routing-type** *routing-number*] [**sequence** *value*] [**time-range** *name*]
 or
deny *protocol* { *source-ipv6-prefix/prefix-length* | **any** | **host** *source-ipv6-address* } [*operator* [*port-number*]] { *destination-ipv6-prefix/prefix-length* | **any** | **host** *destination-ipv6-address* } [*operator* [*port-number*]] [**dest-option-type** [*doh-number* | *doh-type*]] [**dscp** *value*] [**flow-label** *value*] [**fragments**] [**log**] [**log-input**] [**mobility**] [**mobility-type** [*mh-number* | *mh-type*]] [**routing**] [**routing-type** *routing-number*] [**sequence** *value*] [**time-range** *name*] [**undetermined-transport**]

DETAILED STEPS

	Command or Action	Purpose
Step 1	enable Example: Router> enable	Enables privileged EXEC mode. <ul style="list-style-type: none"> • Enter your password if prompted.
Step 2	configure terminal Example: Router# configure terminal	Enters global configuration mode.

Command or Action	Purpose
<p>Step 3</p> <pre>ipv6 access-list access-list-name</pre> <p>Example: Router(config)# ipv6 access-list outbound</p>	<p>Defines an IPv6 ACL and enters IPv6 access list configuration mode. The router prompt changes to Router(config-ipv6-acl)#.</p> <ul style="list-style-type: none"> The <i>access-list name</i> argument specifies the name of the IPv6 ACL. IPv6 ACL names cannot contain a space or quotation mark, or begin with a numeral.
<p>Step 4</p> <pre>permit protocol {source-ipv6-prefix/prefix-length any host source-ipv6-address} [operator [port-number]] {destination-ipv6-prefix/prefix-length any host destination-ipv6-address} [operator [port-number]] [dest-option-type [doh-number doh-type]] [dscp value] [flow-label value] [fragments] [log] [log-input] [mobility] [mobility-type [mh-number mh-type]] [reflect name [timeout value]] [routing] [routing-type routing-number] [sequence value] [time-range name]</pre> <p>or</p> <pre>deny protocol {source-ipv6-prefix/prefix-length any host source-ipv6-address} [operator [port-number]] {destination-ipv6-prefix/prefix-length any host destination-ipv6-address} [operator [port-number]] [dest-option-type [doh-number doh-type]] [dscp value] [flow-label value] [fragments] [log] [log-input] [mobility] [mobility-type [mh-number mh-type]] [routing] [routing-type routing-number] [sequence value] [time-range name] [undetermined-transport]</pre> <p>Example: Router(config-ipv6-acl)# permit tcp 2001:0DB8:0300:0201::/32 any reflect reflectout</p> <p>or</p> <p>Example: Router(config-ipv6-acl)# deny tcp fec0:0:0:0201::/64 any</p>	<p>Specifies permit or deny conditions for an IPv6 ACL.</p> <ul style="list-style-type: none"> The <i>protocol</i> argument specifies the name or number of an Internet protocol. It can be one of the keywords ahp, esp, icmp, ipv6, pcp, sctp, tcp, or udp, or an integer in the range from 0 to 255 representing an IPv6 protocol number. The <i>source-ipv6-prefix/prefix-length</i> and <i>destination-ipv6-prefix/prefix-length</i> arguments specify the source and destination IPv6 network or class of networks about which to set permit conditions. These arguments must be in the form documented in RFC 2373 where the address is specified in hexadecimal using 16-bit values between colons. The any keyword is an abbreviation for the IPv6 prefix <code>::/0</code>. The host source-ipv6-address keyword and argument specify the source IPv6 host address about which to set permit conditions. The <i>source-ipv6-address</i> argument must be in the form documented in RFC 2373 where the address is specified in hexadecimal using 16-bit values between colons. Refer to the permit and deny commands in the <i>IPv6 for Cisco IOS Command Reference</i> document for information on supported arguments and keywords.

Applying the IPv6 Access Class Filter to PAM

Once you have created an IPv6 access class filter, use the following task to apply the filter to PAM.

SUMMARY STEPS

1. **enable**
2. **configure terminal**
3. **ipv6 port-map application-name port port-num [list acl-name]**

DETAILED STEPS

	Command or Action	Purpose
Step 1	enable Example: Router> enable	Enables privileged EXEC mode. <ul style="list-style-type: none"> Enter your password if prompted.
Step 2	configure terminal Example: Router# configure terminal	Enters global configuration mode.
Step 3	ipv6 port-map <i>application-name</i> port <i>port-num</i> [list <i>acl-name</i>] Example: Router(config)# ipv6 port-map ftp port 8090 list PAM_ACL	Establishes PAM for the system.

Verifying IPv6 Security Configuration and Operation

This task explains how to display information to verify the configuration and operation of IPv6 security options. Use the following commands as needed to verify configuration and operation.

SUMMARY STEPS

- show crypto ipsec sa** [**map** *map-name* | **address** | **identity** | **interface** *interface-type interface-number* | **peer** [**vrf** *fvr-name*] **address** | **vrf** *ivrf-name* | **ipv6** [*interface-type interface-number*]] [**detail**]
- show crypto isakmp peer** [**config** | **detail**]
- show crypto isakmp profile**
- show crypto isakmp sa** [**active** | **standby** | **detail** | **nat**]
- show ipv6 access-list** [*access-list-name*]
- show ipv6 inspect** {**name** *inspection-name* | **config** | **interfaces** | **session** [**detail**] | **all**}
- show ipv6 prefix-list** [**detail** | **summary**] [*list-name*]
- show ipv6 virtual-reassembly interface** *interface-type*
- show logging** [**slot** *slot-number* | **summary**]
- show ipv6 port-map** [*application* | **port** *port-number*]

DETAILED STEPS

	Command or Action	Purpose
Step 1	<pre>show crypto ipsec sa [map map-name address identity interface interface-type interface-number peer [vrf fvrf-name] address vrf ivrf-name ipv6 [interface-type interface-number]] [detail]</pre> <p>Example: Router# show crypto ipsec sa ipv6</p>	Displays the settings used by current SAs.
Step 2	<pre>show crypto isakmp peer [config detail]</pre> <p>Example: Router# show crypto isakmp peer</p>	Displays peer descriptions.
Step 3	<pre>show crypto isakmp profile</pre> <p>Example: Router# show crypto isakmp profile</p>	Lists all the ISAKMP profiles that are defined on a router.
Step 4	<pre>show crypto isakmp sa [active standby detail nat]</pre> <p>Example: Router# show crypto isakmp sa</p>	Displays current IKE SAs.
Step 5	<pre>show ipv6 access-list [access-list-name]</pre> <p>Example: Router# show ipv6 access-list</p>	Displays the contents of all current IPv6 access lists.
Step 6	<pre>show ipv6 inspect {name inspection-name config interfaces session [detail] all}</pre> <p>Example: Router# show ipv6 inspect interfaces</p>	Displays CBAC configuration and session information.
Step 7	<pre>show ipv6 prefix-list [detail summary] [list-name]</pre> <p>Example: Router# show ipv6 prefix-list</p>	Displays information about an IPv6 prefix list or IPv6 prefix list entries.
Step 8	<pre>show ipv6 virtual-reassembly interface interface-type</pre> <p>Example: Router# show ipv6 virtual-reassembly interface e1/1</p>	Displays configuration and statistical information of VFR.

	Command or Action	Purpose
Step 9	<pre>show logging [slot slot-number summary]</pre> <p>Example: Router# show logging</p>	Displays the state of system logging (syslog) and the contents of the standard system logging buffer. <ul style="list-style-type: none"> Access list entries with the log or log-input keywords will be logged when a packet matches the access list entry.
Step 10	<pre>show ipv6 port-map [application port port-number]</pre> <p>Example: Router# show ipv6 port-map ftp</p>	Displays PAM configuration.

Troubleshooting IPv6 Security Configuration and Operation

This optional task explains how to display information to troubleshoot the configuration and operation of IPv6 security options. Use the following commands only as needed to verify configuration and operation.

SUMMARY STEPS

- enable
- clear ipv6 access-list [access-list-name]
- clear ipv6 inspect {session session-number | all}
- clear ipv6 prefix-list [prefix-list-name] [ipv6-prefix/prefix-length]
- debug crypto ipsec
- debug crypto engine packet [detail]
- debug ipv6 inspect {function-trace | object-creation | object-deletion | events | timers | protocol | detailed}
- debug ipv6 packet [access-list access-list-name] [detail]

DETAILED STEPS

	Command or Action	Purpose
Step 1	<pre>enable</pre> <p>Example: Router# enable</p>	Enables privileged EXEC mode. <ul style="list-style-type: none"> Enter your password if prompted.
Step 2	<pre>clear ipv6 access-list [access-list-name]</pre> <p>Example: Router# clear ipv6 access-list tin</p>	Resets the IPv6 access list match counters. <ul style="list-style-type: none"> If the <i>access-list-name</i> argument is specified, only the specified access list counters will be reset.

	Command or Action	Purpose
Step 3	<pre>clear ipv6 inspect {session session-number all}</pre> <p>Example: Router# clear ipv6 inspect all</p>	Removes a specific IPv6 session or all IPv6 inspection sessions.
Step 4	<pre>clear ipv6 prefix-list [prefix-list-name] [ipv6-prefix/prefix-length]</pre> <p>Example: Router# clear ipv6 prefix-list</p>	Resets the hit count of the IPv6 prefix list entries.
Step 5	<pre>debug crypto ipsec</pre> <p>Example: Router# debug crypto ipsec</p>	Displays IPsec network events.
Step 6	<pre>debug crypto engine packet [detail]</pre> <p>Example: Router# debug crypto engine packet</p>	Displays the contents of IPv6 packets.  <p>Caution Using this command could flood the system and increase CPU if several packets are being encrypted.</p>
Step 7	<pre>debug ipv6 inspect {function-trace object-creation object-deletion events timers protocol detailed}</pre> <p>Example: Router# debug ipv6 inspect timers</p>	Displays messages about Cisco IOS Firewall events.
Step 8	<pre>debug ipv6 packet [access-list access-list-name] [detail]</pre> <p>Example: Router# debug ipv6 packet access-list PAK-ACL</p>	Displays debugging messages for IPv6 packets. <ul style="list-style-type: none"> If the access-list keyword and <i>access-list-name</i> argument is specified, only packets matching the access list permit entries are displayed.

Examples

This section provides the following output examples:

- [Sample Output for the show crypto ipsec sa ipv6 Command, page 527](#)
- [Sample Output for the show crypto isakmp peer Command, page 528](#)
- [Sample Output for the show crypto isakmp profile Command, page 528](#)
- [Sample Output for the show crypto isakmp sa Command, page 528](#)
- [Sample Output for the show ipv6 access-list Command, page 529](#)
- [Sample Output for the show ipv6 prefix-list Command, page 529](#)
- [Sample Output for the show ipv6 virtual-reassembly Command, page 529](#)
- [Sample Output for the show logging Command, page 530](#)
- [Sample Output for the clear ipv6 access-list Command, page 530](#)

Sample Output for the show crypto ipsec sa ipv6 Command

The following is sample output from the **show crypto ipsec sa ipv6** command:

```
Router# show crypto ipsec sa ipv6

interface: Tunnel0
  Crypto map tag: Tunnel0-head-0, local addr 3FFE:2002::A8BB:CCFF:FE01:9002

protected vrf: (none)
local ident (addr/mask/prot/port): (::/0/0/0)
remote ident (addr/mask/prot/port): (::/0/0/0)
current_peer 3FFE:2002::A8BB:CCFF:FE01:2C02 port 500
  PERMIT, flags={origin_is_acl,}
#pkts encaps: 133, #pkts encrypt: 133, #pkts digest: 133
#pkts decaps: 133, #pkts decrypt: 133, #pkts verify: 133
#pkts compressed: 0, #pkts decompressed: 0
#pkts not compressed: 0, #pkts compr. failed: 0
#pkts not decompressed: 0, #pkts decompress failed: 0
#send errors 60, #recv errors 0

local crypto endpt.: 3FFE:2002::A8BB:CCFF:FE01:9002,
remote crypto endpt.: 3FFE:2002::A8BB:CCFF:FE01:2C02
path mtu 1514, ip mtu 1514
current outbound spi: 0x28551D9A(676666778)

inbound esp sas:
  spi: 0x2104850C(553944332)
    transform: esp-des ,
    in use settings = {Tunnel, }
    conn id: 93, flow_id: SW:93, crypto map: Tunnel0-head-0
    sa timing: remaining key lifetime (k/sec): (4397507/148)
    IV size: 8 bytes
    replay detection support: Y
    Status: ACTIVE

inbound ah sas:
  spi: 0x967698CB(2524354763)
    transform: ah-sha-hmac ,
    in use settings = {Tunnel, }
    conn id: 93, flow_id: SW:93, crypto map: Tunnel0-head-0
    sa timing: remaining key lifetime (k/sec): (4397507/147)
    replay detection support: Y
    Status: ACTIVE

inbound pcp sas:

outbound esp sas:
  spi: 0x28551D9A(676666778)
    transform: esp-des ,
    in use settings = {Tunnel, }
    conn id: 94, flow_id: SW:94, crypto map: Tunnel0-head-0
    sa timing: remaining key lifetime (k/sec): (4397508/147)
    IV size: 8 bytes
    replay detection support: Y
    Status: ACTIVE

outbound ah sas:
  spi: 0xA83E05B5(2822636981)
    transform: ah-sha-hmac ,
    in use settings = {Tunnel, }
    conn id: 94, flow_id: SW:94, crypto map: Tunnel0-head-0
    sa timing: remaining key lifetime (k/sec): (4397508/147)
    replay detection support: Y
```

```
Status: ACTIVE
```

```
outbound pcp sas:
```

Sample Output for the show crypto isakmp peer Command

The following sample output shows peer descriptions on an IPv6 router:

```
Router# show crypto isakmp peer detail

Peer: 2001:0DB8:0:1::1 Port: 500 Local: 2001:0DB8:0:2::1
Phase1 id: 2001:0DB8:0:1::1
flags:
NAS Port: 0 (Normal)
IKE SAs: 1 IPSec SA bundles: 1
last_locker: 0x141A188, last_last_locker: 0x0
last_unlocker: 0x0, last_last_unlocker: 0x0
```

Sample Output for the show crypto isakmp profile Command

The following sample output shows the ISAKMP profiles that are defined on an IPv6 router.

```
Router# show crypto isakmp profile

ISAKMP PROFILE tom
Identities matched are:
ipv6-address 2001:0DB8:0:1::1/32
Certificate maps matched are:
Identity presented is: ipv6-address fqdn
keyring(s): <none>
trustpoint(s): <all>
```

Sample Output for the show crypto isakmp sa Command

The following sample output shows the SAs of an active IPv6 device. The IPv4 device is inactive:

```
Router# show crypto isakmp sa detail

Codes: C - IKE configuration mode, D - Dead Peer Detection
       K - Keepalives, N - NAT-traversal
       X - IKE Extended Authentication
       psk - Preshared key, rsig - RSA signature
       renc - RSA encryption
IPv4 Crypto ISAKMP SA

C-id Local Remote I-VRF Status Encr Hash Auth DH
Lifetime Cap.

IPv6 Crypto ISAKMP SA

dst: 3FFE:2002::A8BB:CCFF:FE01:2C02
src: 3FFE:2002::A8BB:CCFF:FE01:9002
conn-id: 1001 I-VRF: Status: ACTIVE Encr: des Hash: sha Auth:
psk
DH: 1 Lifetime: 23:45:00 Cap: D Engine-id:Conn-id = SW:1

dst: 3FFE:2002::A8BB:CCFF:FE01:2C02
src: 3FFE:2002::A8BB:CCFF:FE01:9002
conn-id: 1002 I-VRF: Status: ACTIVE Encr: des Hash: sha Auth:
psk
DH: 1 Lifetime: 23:45:01 Cap: D Engine-id:Conn-id = SW:2
```

Sample Output for the show ipv6 access-list Command

In the following example, the **show ipv6 access-list** command is used to verify that IPv6 ACLs are configured correctly:

```
Router> show ipv6 access-list
```

```
IPv6 access list inbound
  permit tcp any any eq bgp reflect tcptraffic (8 matches) sequence 10
  permit tcp any any eq telnet reflect tcptraffic (15 matches) sequence 20
  permit udp any any reflect udptraffic sequence 30

IPv6 access list tcptraffic (reflexive) (per-user)
  permit tcp host 2001:0DB8:1::32 eq bgp host 2001:0DB8:2::32 eq 11000 timeout 300 (time
    left 243) sequence 1
  permit tcp host 2001:0DB8:1::32 eq telnet host 2001:0DB8:2::32 eq 11001 timeout 300
    (time left 296) sequence 2

IPv6 access list outbound
  evaluate udptraffic
  evaluate tcptraffic
```



Note

For a description of each output display field, refer to the **show ipv6 access-list** command in the *IPv6 for Cisco IOS Command Reference* document.

Sample Output for the show ipv6 prefix-list Command

The following example shows the output of the **show ipv6 prefix-list** command with the **detail** keyword:

```
Router# show ipv6 prefix-list detail
```

```
Prefix-list with the last deletion/insertion: bgp-in
ipv6 prefix-list 6to4:
  count: 1, range entries: 0, sequences: 5 - 5, refcount: 2
  seq 5 permit 2001:0db8::/32 (hit count: 313, refcount: 1)
ipv6 prefix-list aggregate:
  count: 2, range entries: 2, sequences: 5 - 10, refcount: 30
  seq 5 deny 3FFE:C00::/24 ge 25 (hit count: 568, refcount: 1)
  seq 10 permit ::/0 le 48 (hit count: 31310, refcount: 1)
ipv6 prefix-list bgp-in:
  count: 6, range entries: 3, sequences: 5 - 30, refcount: 31
  seq 5 deny 5F00::/8 le 128 (hit count: 0, refcount: 1)
  seq 10 deny ::/0 (hit count: 0, refcount: 1)
  seq 15 deny ::/1 (hit count: 0, refcount: 1)
  seq 20 deny ::/2 (hit count: 0, refcount: 1)
  seq 25 deny ::/3 ge 4 (hit count: 0, refcount: 1)
  seq 30 permit ::/0 le 128 (hit count: 240664, refcount: 0)
```

Sample Output for the show ipv6 virtual-reassembly Command

```
Router# show ipv6 virtual-reassembly interface e1/1
```

```
Configuration Information:
```

```
-----
Virtual Fragment Reassembly (VFR) is ENABLED...
Maximum number of datagram that can be reassembled at a time: 64
Maximum number of fragments per datagram: 8
Timeout value of a datagram: 3 seconds
```

```
Statistical Information:
```

```
-----
Number of datagram being reassembled:12
Number of fragments being processed:48
```

```
Total number of datagram reassembled:6950
Total number of datagram failed: 9
```

Sample Output for the show logging Command

In the following example, the **show logging** command is used to display logging entries that match the first line (sequence 10) of the access list named tin:

```
Router> show logging

00:00:36: %IPV6-6-ACCESSLOGP: list tin/10 permitted tcp 2001:0db8:1::1(11001)
(Ethernet0/0) -> 2001:0db8:1::2(179), 1 packet
```

Sample Output for the clear ipv6 access-list Command

In the following example, the **show ipv6 access-list** command is used to display some match counters for the access list named tin. Privileged EXEC mode is entered using the **enable** command (not shown) and the **clear ipv6 access-list** EXEC command is issued to reset the match counters for the access list named tin. The **show ipv6 access-list** EXEC command is used again to show that the match counters have been reset.

```
Router> show ipv6 access-list tin

IPv6 access list tin
  permit tcp any any log-input (6 matches) sequence 10
  permit icmp any any echo-request log-input sequence 20
  permit icmp any any echo-reply log-input sequence 30

Router# clear ipv6 access-list tin

Router# show ipv6 access-list tin

IPv6 access list tin
  permit tcp any any log-input sequence 10
  permit icmp any any echo-request log-input sequence 20
  permit icmp any any echo-reply log-input sequence 30
```

Configuration Examples for Implementing Traffic Filters and Firewalls for IPv6 Security

This section provides the following configuration examples:

- [Create and Apply IPv6 ACL: Examples, page 530](#)
- [Controlling Access to a vty: Example, page 532](#)
- [Configuring Cisco IOS Firewall for IPv6: Example, page 532](#)

Create and Apply IPv6 ACL: Examples

Create and Apply an IPv6 ACL Example for Release 12.2(13)T or 12.0(23)S

The following example is from a router running Cisco IOS Release 12.2(13)T.

The example configures two IPv6 ACLs named OUTBOUND and INBOUND and applies both ACLs to outbound and inbound traffic on Ethernet interface 0. The first and second permit entries in the OUTBOUND list permit all TCP and User Datagram Protocol (UDP) packets from network 2001:0DB8:0300:0201::/32 to exit out of Ethernet interface 0. The entries also configure the temporary

IPv6 reflexive ACL named REFLECTOUT to filter returning (incoming) TCP and UDP packets on Ethernet interface 0. The first deny entry in the OUTBOUND list keeps all packets from the network fec0:0:0:0201::/64 (packets that have the site-local prefix fec0:0:0:0201 as the first 64 bits of their source IPv6 address) from exiting out of Ethernet interface 0.

The **evaluate** command in the INBOUND list applies the temporary IPv6 reflexive ACL named REFLECTOUT to inbound TCP and UDP packets on Ethernet interface 0. When outgoing TCP or UDP packets are permitted on Ethernet interface 0 by the OUTBOUND list, the INBOUND list uses the REFLECTOUT list to match (evaluate) the returning (incoming) TCP and UDP packets.

```
ipv6 access-list OUTBOUND
 permit tcp 2001:0DB8:0300:0201::/32 any reflect REFLECTOUT
 permit udp 2001:0DB8:0300:0201::/32 any reflect REFLECTOUT
 deny fec0:0:0:0201::/64 any

ipv6 access-list INBOUND
 evaluate REFLECTOUT

interface ethernet 0
 ipv6 traffic-filter OUTBOUND out
 ipv6 traffic-filter INBOUND in
```



Note

Given that a **permit any any** statement is not included as the last entry in the OUTBOUND or INBOUND ACL, only TCP and UDP packets matching the configured permit entries in the ACL and ICMP packets matching the implicit permit conditions in the ACL are permitted out of and in to Ethernet interface 0 (the implicit deny all condition at the end of the ACL denies all other packet types on the interface).

The following example can be run on a router running Cisco IOS Release 12.2(13)T or 12.0(23)S.

The example configures HTTP access to be restricted to certain hours during the day, and to log any activity outside of the permitted hours.

```
time-range lunchtime
 periodic weekdays 12:00 to 13:00

ipv6 access-list OUTBOUND
 permit tcp any any eq www time-range lunchtime
 deny tcp any any eq www log-input
 permit tcp 2001:0DB8::/32 any
 permit udp 2001:0DB8::/32 any
```

Create and Apply an IPv6 ACL Example for Previous Releases

The following example is from a router running Cisco IOS Release 12.2(11)T or earlier releases, 12.0(21)ST, or 12.0(22)S.

The example configures the IPv6 ACL named list2 and applies the ACL to outbound traffic on Ethernet interface 0. Specifically, the first ACL entry keeps all packets from the network fec0:0:0:2::/64 (packets that have the site-local prefix fec0:0:0:2 as the first 64 bits of their source IPv6 address) from exiting out of Ethernet interface 0. The second entry in the ACL permits all other traffic to exit out of Ethernet interface 0. The second entry is necessary because an implicit deny all condition is at the end of each IPv6 ACL.

```
ipv6 access-list list2 deny fec0:0:0:2::/64 any
 ipv6 access-list list2 permit any any

interface ethernet 0
 ipv6 traffic-filter list2 out
```

If the same configuration was used on a router running Cisco IOS Release 12.2(13)T, 12.0(23)S, or later releases, the configuration would be translated into IPv6 access list configuration mode as follows:

```
ipv6 access-list list2
deny ipv6 fec0:0:0:2::/64 any
permit ipv6 any any

interface ethernet 0
ipv6 traffic-filter list2 out
```

Note

IPv6 is automatically configured as the protocol type in **permit any any** and **deny any any** statements that are translated from global configuration mode to IPv6 access list configuration mode.

Controlling Access to a vty: Example

In the following example, incoming connections to the virtual terminal lines 0 to 4 are filtered based on the IPv6 access list named cisco.

```
ipv6 access-list cisco
permit ipv6 host 2001:0DB8:0:4::2/32 any
!
line vty 0 4
ipv6 access-class cisco in
```

Configuring Cisco IOS Firewall for IPv6: Example

This Cisco IOS Firewall configuration example uses inbound and outbound filters for inspection and makes use of access lists to manage the traffic. The inspect mechanism is the method of permitting return traffic based upon a packet being valid for an existing session for which the state is being maintained.

```
enable
configure terminal
ipv6 unicast-routing
ipv6 inspect name ipv6_test icmp timeout 60
ipv6 inspect name ipv6_test tcp timeout 60
ipv6 inspect name ipv6_test udp timeout 60

interface FastEthernet0/0
ipv6 address 3FFE:C000:0:7::/64 eui-64
ipv6 enable
ipv6 traffic-filter INBOUND out
ipv6 inspect ipv6_test in

interface FastEthernet0/1
ipv6 address 3FFE:C000:1:7::/64 eui-64
ipv6 enable
ipv6 traffic-filter OUTBOUND in

! This is used for 3745b connection to tftpboot server
interface FastEthernet4/0
ip address 192.168.17.33 255.255.255.0
duplex auto
speed 100

ip default-gateway 192.168.17.8
! end of tftpboot server config

! Access-lists to deny everything except for Neighbor Discovery ICMP messages
```

```

ipv6 access-list INBOUND
 permit icmp any any nd-na
 permit icmp any any nd-ns
 deny ipv6 any any log

ipv6 access-list OUTBOUND
 permit icmp any any nd-na
 permit icmp any any nd-ns
 deny ipv6 any any log

```

Additional References

For additional information related to implementing security for IPv6, see the following sections.

Related Documents

Related Topic	Document Title
Security configuration tasks	<i>Cisco IOS Security Configuration Guide</i> , Release 12.4
Security commands: complete command syntax, command mode, defaults, usage guidelines, and examples	<i>Cisco IOS Security Command Reference</i> , Release 12.4
IPv6 supported feature list	<i>Start Here: Cisco IOS Software Release Specifics for IPv6 Features</i>
IPv6 commands: complete command syntax, command mode, defaults, usage guidelines, and examples	<i>IPv6 for Cisco IOS Command Reference</i>
IPv4 configuration and command reference information	<i>Cisco IOS Release 12.4 Configuration Guides and Command References</i>

Standards

Standards	Title
No new or modified standards are supported by this feature, and support for existing standards has not been modified by this feature.	—

MIBs

MIBs	MIBs Link
No new or modified MIBs are supported by this feature, and support for existing MIBs has not been modified by this feature.	To locate and download MIBs for selected platforms, Cisco IOS releases, and feature sets, use Cisco MIB Locator found at the following URL: http://www.cisco.com/go/mibs

RFCs

RFCs	Title
RFC 2401	<i>Security Architecture for the Internet Protocol</i>
RFC 2402	<i>IP Authentication Header</i>
RFC 2428	<i>FTP Extensions for IPv6 and NATs</i>
RFC 2460	<i>Internet Protocol, Version 6 (IPv6) Specification</i>
RFC 2474	<i>Definition of the Differentiated Services Field (DS Field) in the IPv4 and IPv6 Headers</i>
RFC 3576	<i>Change of Authorization</i>

Technical Assistance

Description	Link
The Cisco Technical Support website contains thousands of pages of searchable technical content, including links to products, technologies, solutions, technical tips, and tools. Registered Cisco.com users can log in from this page to access even more content.	http://www.cisco.com/techsupport



Implementing Tunneling for IPv6

This module describes how to configure overlay tunneling techniques used by the Cisco IOS software to support the transition from IPv4-only networks to integrated IPv4- and IPv6-based networks. Tunneling encapsulates IPv6 packets in IPv4 packets and uses the IPv4 network as a link-layer mechanism.

Finding Support Information for Platforms and Cisco IOS Software Images

Use Cisco Feature Navigator to find information about platform support and Cisco IOS software image support. Access Cisco Feature Navigator at <http://www.cisco.com/go/fn>. You must have an account on Cisco.com. If you do not have an account or have forgotten your username or password, click **Cancel** at the login dialog box and follow the instructions that appear.

Contents

- [Prerequisites for Implementing Tunneling for IPv6, page 535](#)
- [Restrictions for Implementing Tunneling for IPv6, page 536](#)
- [Information About Implementing Tunneling for IPv6, page 536](#)
- [How to Implement Tunneling for IPv6, page 541](#)
- [Configuration Examples for Implementing Tunneling for IPv6, page 551](#)
- [Where to Go Next, page 555](#)
- [Additional References, page 555](#)

Prerequisites for Implementing Tunneling for IPv6

This document assumes that you are familiar with IPv4. Refer to the publications referenced in the “[Related Documents](#)” section for IPv4 configuration and command reference information. [Table 36](#) identifies the earliest release for each early-deployment train in which the feature became available.

Table 36 Minimum Required Cisco IOS Release

Feature	Minimum Required Cisco IOS Release by Release Train
Automatic 6-to-4 Tunnels	12.2(2)T, 12.0(21)ST, 12.0(22)S, 12.2(14)S, 12.3, 12.3(2)T, 12.4, 12.4(2)T, 12.2(28)SB, 12.2(33)SRA
Automatic IPv4-Compatible Tunnels	12.2(2)T, 12.0(21)ST, 12.0(22)S, 12.2(14)S, 12.3, 12.3(2)T, 12.4, 12.4(2)T, 12.2(28)SB, 12.2(33)SRA
IPv6 manually configured tunnels	12.2(2)T, 12.0(21)ST, 12.0(23)S, 12.2(14)S, 12.3, 12.3(2)T, 12.4, 12.4(2)T, 12.2(28)SB, 12.2(33)SRA
IPv6 over IPv4 GRE tunnels	12.2(2)T, 12.0(21)ST, 12.0(22)S, 12.2(14)S, 12.3, 12.3(2)T, 12.4, 12.4(2)T, 12.2(28)SB, 12.2(28)SB, 12.2(33)SRA
IPv6 over UTI using a tunnel line card ¹	12.0(23)S
ISATAP tunnels	12.2(14)S, 12.3(2)T, 12.4, 12.4(2)T, 12.2(28)SB, 12.2(33)SRA
GRE Tunnels over an IPv6 Network	12.3(7)T, 12.4, 12.4(2)T, 12.2(30)S, 12.2(33)SRA
IPv4 over IPv6 Tunnels	12.3(7)T, 12.4, 12.4(2)T, 12.2(30)S, 12.2(33)SRA
IPv6 over IPv6 Tunnels	12.3(7)T, 12.4, 12.4(2)T, 12.2(30)S, 12.2(33)SRA
CLNS Support for GRE Tunneling of IPv4 and IPv6 in CTunnels	12.3(7)T, 12.2(25)S, 12.4, 12.4(2)T, 12.2(28)SB, 12.2(33)SRA

1. Supported on the Cisco 12000 series Internet router only.

Restrictions for Implementing Tunneling for IPv6

In Cisco IOS Release 12.0(21)ST and Cisco IOS Release 12.0(22)S and earlier releases, the Cisco 12000 series gives a very low priority to the processing of IPv6 tunneled packets. Therefore, we strongly recommend that you limit the use of IPv6 tunnels on the Cisco 12000 series using these releases to topologies that sustain a low level of network traffic and require a minimal amount of process-switching resources. IPv6 manually configured tunnel traffic in Cisco IOS Release 12.0(23)S is processed in software on the CPU of the line card, instead of in the Route Processor (RP) in the Cisco 12000 router, resulting in enhanced performance.

Information About Implementing Tunneling for IPv6

To configure tunneling for IPv6, you need to understand the following concepts:

- [Overlay Tunnels for IPv6, page 537](#)
- [IPv6 Manually Configured Tunnels, page 538](#)
- [GRE/IPv4 Tunnel Support for IPv6 Traffic, page 539](#)
- [GRE/CLNS Tunnel Support for IPv4 and IPv6 Packets, page 539](#)
- [Automatic 6to4 Tunnels, page 539](#)
- [Automatic IPv4-Compatible IPv6 Tunnels, page 540](#)
- [ISATAP Tunnels, page 540](#)

Overlay Tunnels for IPv6

Overlay tunneling encapsulates IPv6 packets in IPv4 packets for delivery across an IPv4 infrastructure (a core network or the Internet). (See [Figure 37](#).) By using overlay tunnels, you can communicate with isolated IPv6 networks without upgrading the IPv4 infrastructure between them. Overlay tunnels can be configured between border routers or between a border router and a host; however, both tunnel endpoints must support both the IPv4 and IPv6 protocol stacks. Cisco IOS IPv6 supports the following types of overlay tunneling mechanisms:

- Manual
- Generic routing encapsulation (GRE)
- IPv4-compatible
- 6to4
- Intra-Site Automatic Tunnel Addressing Protocol (ISATAP)

Figure 37 *Overlay Tunnels*

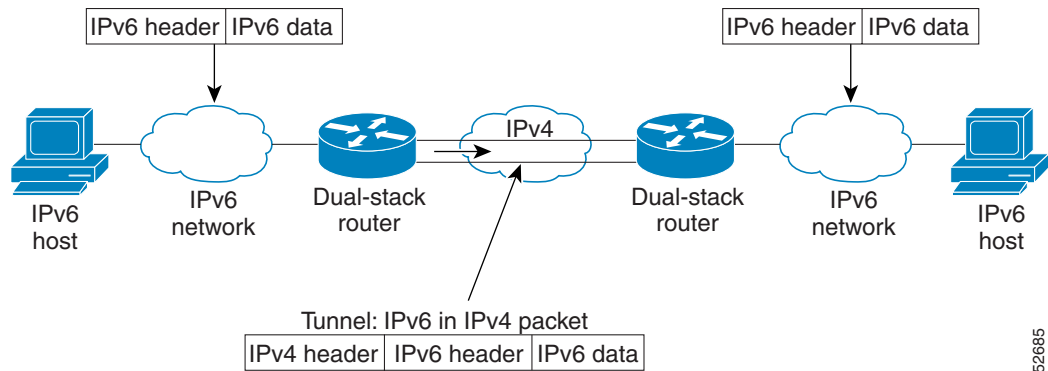

52685

Note

Overlay tunnels reduce the maximum transmission unit (MTU) of an interface by 20 octets (assuming the basic IPv4 packet header does not contain optional fields). A network using overlay tunnels is difficult to troubleshoot. Therefore, overlay tunnels connecting isolated IPv6 networks should not be considered as a final IPv6 network architecture. The use of overlay tunnels should be considered as a transition technique toward a network that supports both the IPv4 and IPv6 protocol stacks or just the IPv6 protocol stack.

Use [Table 37](#) to help you determine which type of tunnel you want to configure to carry IPv6 packets over an IPv4 network.

Table 37 *Suggested Usage of Tunnel Types to Carry IPv6 Packets over an IPv4 Network*

Tunneling Type	Suggested Usage	Usage Notes
Manual	Simple point-to-point tunnels that can be used within a site or between sites	Can carry IPv6 packets only.
GRE- and IPv4-compatible	Simple point-to-point tunnels that can be used within a site or between sites	Can carry IPv6, Connectionless Network Service (CLNS), and many other types of packets.

Table 37 Suggested Usage of Tunnel Types to Carry IPv6 Packets over an IPv4 Network

Tunneling Type	Suggested Usage	Usage Notes
IPv4-compatible	Point-to-multipoint tunnels	Uses the <code>::/96</code> prefix. We do not now recommend using this tunnel type.
6to4	Point-to-multipoint tunnels that can be used to connect isolated IPv6 sites	Sites use addresses from the <code>2002::/16</code> prefix.
ISATAP	Point-to-multipoint tunnels that can be used to connect systems within a site	Sites can use any IPv6 unicast addresses.

Individual tunnel types are discussed in detail in this document. We recommend that you review and understand the information about the specific tunnel type that you want to implement. When you are familiar with the type of tunnel you need, see [Table 38](#) for a summary of the tunnel configuration parameters that you may find useful.

Table 38 Tunnel Configuration Parameters by Tunneling Type

Tunneling Type	Tunnel Configuration Parameter			
	Tunnel Mode	Tunnel Source	Tunnel Destination	Interface Prefix or Address
Manual	ipv6ip	An IPv4 address, or a reference to an interface on which IPv4 is configured.	An IPv4 address.	An IPv6 address.
GRE/IPv4	gre ip		An IPv4 address.	An IPv6 address.
IPv4-compatible	ipv6ip auto-tunnel		Not required. These are all point-to-multipoint tunneling types.	Not required. The interface address is generated as <code>::tunnel-source/96</code> .
6to4	ipv6ip 6to4		The IPv4 destination address is calculated, on a per-packet basis, from the IPv6 destination.	An IPv6 address. The prefix must embed the tunnel source IPv4 address
ISATAP	ipv6ip isatap		An IPv6 prefix in modified eui-64 format. The IPv6 address is generated from the prefix and the tunnel source IPv4 address.	

IPv6 Manually Configured Tunnels

A manually configured tunnel is equivalent to a permanent link between two IPv6 domains over an IPv4 backbone. The primary use is for stable connections that require regular secure communication between two edge routers or between an end system and an edge router, or for connection to remote IPv6 networks.

An IPv6 address is manually configured on a tunnel interface, and manually configured IPv4 addresses are assigned to the tunnel source and the tunnel destination. The host or router at each end of a configured tunnel must support both the IPv4 and IPv6 protocol stacks. Manually configured tunnels can be configured between border routers or between a border router and a host. Cisco Express Forwarding switching can be used for IPv6 manually configured tunnels, or Cisco Express Forwarding switching can be disabled if process switching is needed.

GRE/IPv4 Tunnel Support for IPv6 Traffic

IPv6 traffic can be carried over IPv4 GRE tunnels using the standard GRE tunneling technique that is designed to provide the services necessary to implement any standard point-to-point encapsulation scheme. As in IPv6 manually configured tunnels, GRE tunnels are links between two points, with a separate tunnel for each link. The tunnels are not tied to a specific passenger or transport protocol, but in this case carry IPv6 as the passenger protocol with the GRE as the carrier protocol and IPv4 or IPv6 as the transport protocol.

The primary use of GRE tunnels is for stable connections that require regular secure communication between two edge routers or between an edge router and an end system. The edge routers and the end systems must be dual-stack implementations.

GRE has a protocol field that identifies the passenger protocol. GRE tunnels allow Intermediate System-to-Intermediate System (IS-IS) or IPv6 to be specified as a passenger protocol, which allows both IS-IS and IPv6 traffic to run over the same tunnel. If GRE did not have a protocol field, it would be impossible to distinguish whether the tunnel was carrying IS-IS or IPv6 packets. The GRE protocol field is why it is desirable that you tunnel IS-IS and IPv6 inside GRE.

GRE/CLNS Tunnel Support for IPv4 and IPv6 Packets

GRE tunneling of IPv4 and IPv6 packets through CLNS networks enables Cisco CLNS Tunnels (CTunnels) to interoperate with networking equipment from other vendors. This feature provides compliance with RFC 3147.

The optional GRE services defined in header fields, such as checksums, keys, and sequencing, are not supported. Any packet received requesting such services will be dropped.

Refer to *CLNS Support for GRE Tunneling of IPv4 and IPv6 Packets, Release 12.3(7)T* for details about this feature, and *Cisco IOS Network Protocols 3: ISO CLNS, Release 12.4* for information about CTunnels.

Automatic 6to4 Tunnels

An automatic 6to4 tunnel allows isolated IPv6 domains to be connected over an IPv4 network to remote IPv6 networks. The key difference between automatic 6to4 tunnels and manually configured tunnels is that the tunnel is not point-to-point; it is point-to-multipoint. In automatic 6to4 tunnels, routers are not configured in pairs because they treat the IPv4 infrastructure as a virtual nonbroadcast multiaccess (NBMA) link. The IPv4 address embedded in the IPv6 address is used to find the other end of the automatic tunnel.

An automatic 6to4 tunnel may be configured on a border router in an isolated IPv6 network, which creates a tunnel on a per-packet basis to a border router in another IPv6 network over an IPv4 infrastructure. The tunnel destination is determined by the IPv4 address of the border router extracted from the IPv6 address that starts with the prefix 2002::/16, where the format is 2002:border-router-IPv4-address::/48. Following the embedded IPv4 address are 16 bits that can be used to number networks within the site. The border router at each end of a 6to4 tunnel must support both the IPv4 and IPv6 protocol stacks. 6to4 tunnels are configured between border routers or between a border router and a host.

The simplest deployment scenario for 6to4 tunnels is to interconnect multiple IPv6 sites, each of which has at least one connection to a shared IPv4 network. This IPv4 network could be the global Internet or a corporate backbone. The key requirement is that each site have a globally unique IPv4 address; the

Cisco IOS software uses this address to construct a globally unique 6to4/48 IPv6 prefix. As with other tunnel mechanisms, appropriate entries in a Domain Name System (DNS) that map between hostnames and IP addresses for both IPv4 and IPv6 allow the applications to choose the required address.

Automatic IPv4-Compatible IPv6 Tunnels

Automatic IPv4-compatible tunnels use IPv4-compatible IPv6 addresses. IPv4-compatible IPv6 addresses are IPv6 unicast addresses that have zeros in the high-order 96 bits of the address, and an IPv4 address in the low-order 32 bits. They can be written as 0:0:0:0:0:A.B.C.D or ::A.B.C.D, where “A.B.C.D” represents the embedded IPv4 address.

The tunnel destination is automatically determined by the IPv4 address in the low-order 32 bits of IPv4-compatible IPv6 addresses. The host or router at each end of an IPv4-compatible tunnel must support both the IPv4 and IPv6 protocol stacks. IPv4-compatible tunnels can be configured between border-routers or between a border-router and a host. Using IPv4-compatible tunnels is an easy method to create tunnels for IPv6 over IPv4, but the technique does not scale for large networks.



Note

IPv4-compatible tunnels were initially supported for IPv6, but are being deprecated. Cisco recommends that you use the IPv6 ISATAP tunneling technique.

ISATAP Tunnels

ISATAP is an automatic overlay tunneling mechanism that uses the underlying IPv4 network as a NBMA link layer for IPv6. ISATAP is designed for transporting IPv6 packets *within* a site where a native IPv6 infrastructure is not yet available; for example, when sparse IPv6 hosts are deployed for testing. ISATAP tunnels allow individual IPv4 or IPv6 dual-stack hosts within a site to communicate with other such hosts on the same virtual link, basically creating an IPv6 network using the IPv4 infrastructure.

The ISATAP router provides standard router advertisement network configuration support for the ISATAP site. This feature allows clients to automatically configure themselves as they would do if they were connected to an Ethernet. It can also be configured to provide connectivity out of the site. ISATAP uses a well-defined IPv6 address format composed of any unicast IPv6 prefix (/64), which can be link local, or global (including 6to4 prefixes), enabling IPv6 routing locally or on the Internet. The IPv4 address is encoded in the last 32 bits of the IPv6 address, enabling automatic IPv6-in-IPv4 tunneling.

Although the ISATAP tunneling mechanism is similar to other automatic tunneling mechanisms, such as IPv6 6to4 tunneling, ISATAP is designed for transporting IPv6 packets *within* a site, not *between* sites.

ISATAP uses unicast addresses that include a 64-bit IPv6 prefix and a 64-bit interface identifier. The interface identifier is created in modified EUI-64 format in which the first 32 bits contain the value 000:5EFE to indicate that the address is an IPv6 ISATAP address. [Table 39](#) describes an ISATAP address format.

Table 39 IPv6 ISATAP Address Format

64 Bits	32 Bits	32 Bits
link local or global IPv6 unicast prefix	0000:5EFE	IPv4 address of the ISATAP link

As shown in [Table 39](#), an ISATAP address consists of an IPv6 prefix and the ISATAP interface identifier. This interface identifier includes the IPv4 address of the underlying IPv4 link. The following example shows what an actual ISATAP address would look like if the prefix is 2001:0DB8:1234:5678::/64 and the embedded IPv4 address is 10.173.129.8. In the ISATAP address, the IPv4 address is expressed in hexadecimal as 0AAD:8108.

Example:

```
2001:0DB8:1234:5678:0000:5EFE:0AAD:8108
```

IPv6 IPSec Site-to-Site Protection Using Virtual Tunnel Interface

The IPv6 IPSec feature provides IPv6 crypto site-to-site protection of all types of IPv6 unicast and multicast traffic using native IPSec IPv6 encapsulation. The IPSec virtual tunnel interface (VTI) feature provides this function, using IKE as the management protocol.

An IPSec VTI supports native IPSec tunneling and includes most of the properties of a physical interface. The IPSec VTI alleviates the need to apply crypto maps to multiple interfaces and provides a routable interface.

The IPSec VTI allows IPv6 routers to work as security gateways, establish IPSec tunnels between other security gateway routers, and provide crypto IPSec protection for traffic from internal network when being transmitting across the public IPv6 Internet.

For further information on VTIs, see the *Implementing IPSec on IPv6* module.

How to Implement Tunneling for IPv6

The following sections explain how to implement tunneling for IPv6:

- [Configuring Manual IPv6 Tunnels, page 541](#)
- [Configuring GRE IPv6 Tunnels, page 543](#)
- [Configuring 6to4 Tunnels, page 544](#)
- [Configuring IPv4-Compatible IPv6 Tunnels, page 546](#)
- [Configuring ISATAP Tunnels, page 547](#)

Configuring Manual IPv6 Tunnels

This task explains how to configure a IPv6 overlay tunnel manually.

Prerequisites

With manually configured IPv6 tunnels, an IPv6 address is configured on a tunnel interface, and manually configured IPv4 addresses are assigned to the tunnel source and the tunnel destination. The host or router at each end of a configured tunnel must support both the IPv4 and IPv6 protocol stacks.

SUMMARY STEPS

1. **enable**

2. **configure terminal**
3. **interface tunnel** *tunnel-number*
4. **ipv6 address** *ipv6-prefix/prefix-length* [**eui-64**]
5. **tunnel source** {*ip-address* | *interface-type interface-number*}
6. **tunnel destination** *ip-address*
7. **tunnel mode ipv6ip**

DETAILED STEPS

	Command or Action	Purpose
Step 1	enable Example: Router> enable	Enables privileged EXEC mode. <ul style="list-style-type: none"> Enter your password if prompted.
Step 2	configure terminal Example: Router# configure terminal	Enters global configuration mode.
Step 3	interface tunnel <i>tunnel-number</i> Example: Router(config)# interface tunnel 0	Specifies a tunnel interface and number, and enters interface configuration mode.
Step 4	ipv6 address <i>ipv6-prefix/prefix-length</i> [eui-64] Example: Router(config-if)# ipv6 address 3ffe:b00:c18:1::3/127	Specifies the IPv6 network assigned to the interface and enables IPv6 processing on the interface. Note Refer to the <i>Configuring Basic Connectivity for IPv6</i> module for more information on configuring IPv6 addresses.
Step 5	tunnel source { <i>ip-address</i> <i>interface-type interface-number</i> } Example: Router(config-if)# tunnel source ethernet 0	Specifies the source IPv4 address or the source interface type and number for the tunnel interface. <ul style="list-style-type: none"> If an interface is specified, the interface must be configured with an IPv4 address.
Step 6	tunnel destination <i>ip-address</i> Example: Router(config-if)# tunnel destination 192.168.30.1	Specifies the destination IPv4 address or hostname for the tunnel interface.
Step 7	tunnel mode ipv6ip Example: Router(config-if)# tunnel mode ipv6ip	Specifies a manual IPv6 tunnel. Note The tunnel mode ipv6ip command specifies IPv6 as the passenger protocol and IPv4 as both the encapsulation and transport protocol for the manual IPv6 tunnel.

What to Do Next

Proceed to the “[Verifying IPv6 Tunnel Configuration and Operation](#)” section on page 549.

Configuring GRE IPv6 Tunnels

This task explains how to configure a GRE tunnel on an IPv6 network. GRE tunnels can be configured to run over an IPv6 network layer and to transport IPv6 packets in IPv6 tunnels and IPv4 packets in IPv6 tunnels.

Prerequisites

When GRE IPv6 tunnels are configured, IPv6 addresses are assigned to the tunnel source and the tunnel destination. The tunnel interface can have either IPv4 or IPv6 addresses assigned (this is not shown in the task). The host or router at each end of a configured tunnel must support both the IPv4 and IPv6 protocol stacks.

SUMMARY STEPS

1. **enable**
2. **configure terminal**
3. **interface tunnel** *tunnel-number*
4. **ipv6 address** *ipv6-prefix/prefix-length* [**eui-64**]
5. **tunnel source** { *ip-address* | *ipv6-address* | *interface-type interface-number* }
6. **tunnel destination** { *host-name* | *ip-address* | *ipv6-address* }
7. **tunnel mode** { **aurp** | **cayman** | **dvmrp** | **eon** | **gre** | **gre multipoint** | **gre ipv6** | **ipip** | **decapsulate-any** | **iptalk** | **ipv6** | **mpls** | **nos** }

DETAILED STEPS

	Command or Action	Purpose
Step 1	enable Example: Router> enable	Enables privileged EXEC mode. <ul style="list-style-type: none">• Enter your password if prompted.
Step 2	configure terminal Example: Router# configure terminal	Enters global configuration mode.
Step 3	interface tunnel <i>tunnel-number</i> Example: Router(config)# interface tunnel 0	Specifies a tunnel interface and number, and enters interface configuration mode.

	Command or Action	Purpose
Step 4	<p>ipv6 address <i>ipv6-prefix/prefix-length</i> [eui-64]</p> <p>Example: Router(config-if)# ipv6 address 3ffe:b00:c18:1::3/127</p>	<p>Specifies the IPv6 network assigned to the interface and enables IPv6 processing on the interface.</p> <p>Note Refer to the <i>Implementing Basic Connectivity for IPv6</i> module for more information on configuring IPv6 addresses.</p>
Step 5	<p>tunnel source {<i>ip-address</i> <i>ipv6-address</i> <i>interface-type interface-number</i>}</p> <p>Example: Router(config-if)# tunnel source ethernet 0</p>	<p>Specifies the source IPv4 address or the source interface type and number for the tunnel interface.</p> <ul style="list-style-type: none"> If an interface is specified, the interface must be configured with an IPv4 address.
Step 6	<p>tunnel destination {<i>host-name</i> <i>ip-address</i> <i>ipv6-address</i>}</p> <p>Example: Router(config-if)# tunnel destination 192.168.30.1</p>	<p>Specifies the destination IPv4 address or hostname for the tunnel interface.</p>
Step 7	<p>tunnel mode {<i>aurp</i> <i>cayman</i> <i>dvmrp</i> <i>eon</i> gre gre multipoint gre ipv6 ipip [<i>decapsulate-any</i>] <i>iptalk</i> <i>ipv6</i> <i>mpls</i> <i>nos</i>}</p> <p>Example: Router(config-if)# tunnel mode gre ipv6</p>	<p>Specifies a GRE IPv6 tunnel.</p> <p>Note The tunnel mode gre ipv6 command specifies GRE as the encapsulation protocol for the tunnel.</p>

What to Do Next

Proceed to the [“Verifying IPv6 Tunnel Configuration and Operation”](#) section on page 549.

Configuring 6to4 Tunnels

This task explains how to configure a 6to4 overlay tunnel.

Prerequisites

With 6to4 tunnels, the tunnel destination is determined by the border router IPv4 address, which is concatenated to the prefix 2002::/16 in the format `2002:border-router-IPv4-address::/48`. The border router at each end of a 6to4 tunnel must support both the IPv4 and IPv6 protocol stacks.

Restrictions

The configuration of only one IPv4-compatible tunnel and one 6to4 IPv6 tunnel is supported on a router. If you choose to configure both of those tunnel types on the same router, we strongly recommend that they do not share the same tunnel source.

The reason that a 6to4 tunnel and an IPv4-compatible tunnel cannot share an interface is that both of them are NBMA “point-to-multipoint” access links and only the tunnel source can be used to reorder the packets from a multiplexed packet stream into a single packet stream for an incoming interface. So when

a packet with an IPv4 protocol type of 41 arrives on an interface, that packet is mapped to an IPv6 tunnel interface based on the IPv4 address. However, if both the 6to4 tunnel and the IPv4-compatible tunnel share the same source interface, the router is not able to determine the IPv6 tunnel interface to which it should assign the incoming packet.

IPv6 manually configured tunnels can share the same source interface because a manual tunnel is a “point-to-point” link, and both the IPv4 source and IPv4 destination of the tunnel are defined.

SUMMARY STEPS

1. **enable**
2. **configure terminal**
3. **interface tunnel** *tunnel-number*
4. **ipv6 address** *ipv6-prefix/prefix-length* [**eui-64**]
5. **tunnel source** {*ip-address* | *interface-type interface-number*}
6. **tunnel mode ipv6ip 6to4**
7. **exit**
8. **ipv6 route** *ipv6-prefix/prefix-length* **tunnel** *tunnel-number*

DETAILED STEPS

	Command or Action	Purpose
Step 1	enable Example: Router> enable	Enables privileged EXEC mode. <ul style="list-style-type: none"> • Enter your password if prompted.
Step 2	configure terminal Example: Router# configure terminal	Enters global configuration mode.
Step 3	interface tunnel <i>tunnel-number</i> Example: Router(config)# interface tunnel 0	Specifies a tunnel interface and number, and enters interface configuration mode.
Step 4	ipv6 address <i>ipv6-prefix/prefix-length</i> [eui-64] Example: Router(config-if)# ipv6 address 2002:c0a8:6301:1::1/64	Specifies the IPv6 address assigned to the interface and enables IPv6 processing on the interface. <ul style="list-style-type: none"> • The 32 bits following the initial 2002::/16 prefix correspond to an IPv4 address assigned to the tunnel source. <p>Note Refer to the <i>Configuring Basic Connectivity for IPv6</i> module for more information on configuring IPv6 addresses.</p>

	Command or Action	Purpose
Step 5	tunnel source { <i>ip-address</i> <i>interface-type</i> <i>interface-number</i> } Example: Router(config-if)# tunnel source ethernet 0	Specifies the source interface type and number for the tunnel interface. Note The interface type and number specified in the tunnel source command must be configured with an IPv4 address.
Step 6	tunnel mode ipv6ip 6to4 Example: Router(config-if)# tunnel mode ipv6ip 6to4	Specifies an IPv6 overlay tunnel using a 6to4 address.
Step 7	exit Example: Router(config-if)# exit	Exits interface configuration mode, and returns the router to global configuration mode.
Step 8	ipv6 route <i>ipv6-prefix/prefix-length</i> tunnel <i>tunnel-number</i> Example: Router(config)# ipv6 route 2002::/16 tunnel 0	Configures a static route for the IPv6 6to4 prefix 2002::/16 to the specified tunnel interface. Note When configuring a 6to4 overlay tunnel, you must configure a static route for the IPv6 6to4 prefix 2002::/16 to the 6to4 tunnel interface. <ul style="list-style-type: none"> The tunnel number specified in the ipv6 route command must be the same tunnel number specified in the interface tunnel command.

What to Do Next

Proceed to the [“Verifying IPv6 Tunnel Configuration and Operation”](#) section on page 549.

Configuring IPv4-Compatible IPv6 Tunnels

This task explains how to configure an IPv4-compatible IPv6 overlay tunnel.

Prerequisites

With an IPv4-compatible tunnel, the tunnel destination is automatically determined by the IPv4 address in the low-order 32 bits of IPv4-compatible IPv6 addresses. The host or router at each end of an IPv4-compatible tunnel must support both the IPv4 and IPv6 protocol stacks.

SUMMARY STEPS

1. **enable**
2. **configure terminal**
3. **interface tunnel** *tunnel-number*
4. **tunnel source** {*ip-address* | *interface-type* *interface-number*}
5. **tunnel mode ipv6ip auto-tunnel**

DETAILED STEPS

	Command or Action	Purpose
Step 1	enable Example: Router> enable	Enables privileged EXEC mode. <ul style="list-style-type: none"> Enter your password if prompted.
Step 2	configure terminal Example: Router# configure terminal	Enters global configuration mode.
Step 3	interface tunnel <i>tunnel-number</i> Example: Router(config)# interface tunnel 0	Specifies a tunnel interface and number, and enters interface configuration mode.
Step 4	tunnel source { <i>ip-address</i> <i>interface-type</i> <i>interface-number</i> } Example: Router(config-if)# tunnel source ethernet 0	Specifies the source interface type and number for the tunnel interface. Note The interface type and number specified in the tunnel source command is configured with an IPv4 address only.
Step 5	tunnel mode ipv6ip auto-tunnel Example: Router(config-if)# tunnel mode ipv6ip auto-tunnel	Specifies an IPv4-compatible tunnel using an IPv4-compatible IPv6 address.

What to Do Next

Proceed to the [“Verifying IPv6 Tunnel Configuration and Operation”](#) section on page 549.

Configuring ISATAP Tunnels

This task describes how to configure an ISATAP overlay tunnel.

Prerequisites

The **tunnel source** command used in the configuration of an ISATAP tunnel must point to an interface with an IPv4 address configured. The ISATAP IPv6 address and prefix (or prefixes) advertised are configured as for a native IPv6 interface. The IPv6 tunnel interface must be configured with a modified EUI-64 address because the last 32 bits in the interface identifier are constructed using the IPv4 tunnel source address.

SUMMARY STEPS

1. **enable**
2. **configure terminal**

3. **interface tunnel** *tunnel-number*
4. **ipv6 address** *ipv6-prefix/prefix-length* [eui-64]
5. **no ipv6 nd suppress-ra**
6. **tunnel source** {*ip-address* | *interface-type interface-number*}
7. **tunnel mode ipv6ip isatap**

DETAILED STEPS

	Command or Action	Purpose
Step 1	enable Example: Router> enable	Enables privileged EXEC mode. <ul style="list-style-type: none"> • Enter your password if prompted.
Step 2	configure terminal Example: Router# configure terminal	Enters global configuration mode.
Step 3	interface tunnel <i>tunnel-number</i> Example: Router(config)# interface tunnel 1	Specifies a tunnel interface and number, and enters interface configuration mode.
Step 4	ipv6 address <i>ipv6-prefix/prefix-length</i> [eui-64] Example: Router(config-if)# ipv6 address 2001:0DB8:6301::/64 eui-64	Specifies the IPv6 address assigned to the interface and enables IPv6 processing on the interface. Note Refer to the <i>Configuring Basic Connectivity for IPv6</i> module for more information on configuring IPv6 addresses.
Step 5	no ipv6 nd suppress-ra Example: Router(config-if)# no ipv6 nd suppress-ra	Sending of IPv6 router advertisements is disabled by default on tunnel interfaces. This command reenables the sending of IPv6 router advertisements to allow client autoconfiguration.
Step 6	tunnel source { <i>ip-address</i> <i>interface-type interface-number</i> } Example: Router(config-if)# tunnel source ethernet 1/0/1	Specifies the source interface type and number for the tunnel interface. Note The interface type and number specified in the tunnel source command must be configured with an IPv4 address.
Step 7	tunnel mode ipv6ip isatap Example: Router(config-if)# tunnel mode ipv6ip isatap	Specifies an IPv6 overlay tunnel using a ISATAP address.

What to Do Next

Proceed to the [“Verifying IPv6 Tunnel Configuration and Operation”](#) section on page 549.

Verifying IPv6 Tunnel Configuration and Operation

This optional task explains how to verify IPv6 tunnel configuration and operation. The commands contained in the task steps can be used in any sequence and may need to be repeated.

SUMMARY STEPS

1. `enable`
2. `show interfaces tunnel number [accounting]`
3. `ping [protocol] destination`
4. `show ip route [address [mask]]`

DETAILED STEPS

	Command or Action	Purpose
Step 1	<code>enable</code> Example: Router> enable	Enables privileged EXEC mode. <ul style="list-style-type: none"> • Enter your password if prompted.
Step 2	<code>show interfaces tunnel number [accounting]</code> Example: Router# show interfaces tunnel 0	(Optional) Displays tunnel interface information. <ul style="list-style-type: none"> • Use the <i>number</i> argument to display information for a specified tunnel.
Step 3	<code>ping [protocol] destination</code> Example: Router# ping 10.0.0.1	(Optional) Diagnoses basic network connectivity.
Step 4	<code>show ip route [address [mask]]</code> Example: Router# show ip route 10.0.0.2	(Optional) Displays the current state of the routing table. Note Only the syntax relevant for this task is shown.

Examples

This section provides the following output examples:

- [Sample Output for the show interfaces tunnel Command](#)
- [Sample Output for the ping Command](#)
- [Sample Output for the show ip route Command](#)
- [Sample Output for the ping Command](#)

Sample Output for the show interfaces tunnel Command

This example uses a generic example suitable for both IPv6 manually configured tunnels and IPv6 over IPv4 GRE tunnels. In the example, two routers are configured to be endpoints of a tunnel. Router A has Ethernet interface 0/0 configured as tunnel interface 0 with an IPv4 address of 10.0.0.1 and an IPv6

prefix of 2001:0DB8:1111:2222::1/64. Router B has Ethernet interface 0/0 configured as tunnel interface 1 with an IPv4 address of 10.0.0.2 and an IPv6 prefix of 2001:0DB8:1111:2222::2/64. To verify that the tunnel source and destination addresses are configured, use the **show interfaces tunnel** command on Router A.

```
RouterA# show interfaces tunnel 0

Tunnel0 is up, line protocol is up
  Hardware is Tunnel
  MTU 1514 bytes, BW 9 Kbit, DLY 500000 usec,
    reliability 255/255, txload 1/255, rxload 1/255
  Encapsulation TUNNEL, loopback not set
  Keepalive not set
  Tunnel source 10.0.0.1 (Ethernet0/0), destination 10.0.0.2, fastswitch TTL 255
  Tunnel protocol/transport GRE/IP, key disabled, sequencing disabled
  Tunnel TTL 255
  Checksumming of packets disabled, fast tunneling enabled
  Last input 00:00:14, output 00:00:04, output hang never
  Last clearing of "show interface" counters never
  Input queue: 0/75/0/0 (size/max/drops/flushes); Total output drops: 0
  Queueing strategy: fifo
  Output queue :0/0 (size/max)
  5 minute input rate 0 bits/sec, 0 packets/sec
  5 minute output rate 0 bits/sec, 0 packets/sec
    4 packets input, 352 bytes, 0 no buffer
    Received 0 broadcasts, 0 runts, 0 giants, 0 throttles
    0 input errors, 0 CRC, 0 frame, 0 overrun, 0 ignored, 0 abort
    8 packets output, 704 bytes, 0 underruns
    0 output errors, 0 collisions, 0 interface resets
    0 output buffer failures, 0 output buffers swapped out
```

Sample Output for the ping Command

To check that the local endpoint is configured and working, use the **ping** command on Router A:

```
RouterA# ping 2001:0DB8:1111:2222::2

Type escape sequence to abort.
Sending 5, 100-byte ICMP Echos to 2001:0DB8:1111:2222::2, timeout is 2 seconds:
!!!!
Success rate is 100 percent (5/5), round-trip min/avg/max = 20/20/20 ms
```

Sample Output for the show ip route Command

To check that a route exists to the remote endpoint address, use the **show ip route** command:

```
RouterA# show ip route 10.0.0.2

Routing entry for 10.0.0.0/24
  Known via "connected", distance 0, metric 0 (connected, via interface)
  Routing Descriptor Blocks:
  * directly connected, via Ethernet0/0
    Route metric is 0, traffic share count is 1
```

Sample Output for the ping Command

To check that the remote endpoint address is reachable, use the **ping** command on Router A.



Note

The remote endpoint address may not be reachable using the **ping** command because of filtering, but the tunnel traffic may still reach its destination.

```
RouterA# ping 10.0.0.2
```

```
Type escape sequence to abort.  
Sending 5, 100-byte ICMP Echos to 10.0.0.2, timeout is 2 seconds:  
!!!!  
Success rate is 100 percent (5/5), round-trip min/avg/max = 20/21/28 ms
```

To check that the remote IPv6 tunnel endpoint is reachable, use the **ping** command again on Router A. The same note on filtering also applies to this example.

```
RouterA# ping 1::2
```

```
Type escape sequence to abort.  
Sending 5, 100-byte ICMP Echos to 1::2, timeout is 2 seconds:  
!!!!  
Success rate is 100 percent (5/5), round-trip min/avg/max = 20/20/20 ms
```

These steps may be repeated at the other endpoint of the tunnel.

Configuration Examples for Implementing Tunneling for IPv6

This section provides the following configuration examples:

- [Configuring Manual IPv6 Tunnels: Example, page 551](#)
- [Configuring GRE Tunnels: Examples, page 552](#)
- [Configuring 6to4 Tunnels Example, page 554](#)
- [Configuring IPv4-Compatible IPv6 Tunnels Example, page 554](#)
- [Configuring ISATAP Tunnels Example, page 555](#)

Configuring Manual IPv6 Tunnels: Example

The following example configures a manual IPv6 tunnel between router A and router B. In the example, tunnel interface 0 for both router A and router B is manually configured with a global IPv6 address. The tunnel source and destination addresses are also manually configured.

Router A Configuration

```
interface ethernet 0  
 ip address 192.168.99.1 255.255.255.0  
  
interface tunnel 0  
 ipv6 address 3ffe:b00:c18:1::3/127  
 tunnel source ethernet 0  
 tunnel destination 192.168.30.1  
 tunnel mode ipv6ip
```

Router B Configuration

```
interface ethernet 0  
 ip address 192.168.30.1 255.255.255.0  
  
interface tunnel 0  
 ipv6 address 3ffe:b00:c18:1::2/127  
 tunnel source ethernet 0  
 tunnel destination 192.168.99.1  
 tunnel mode ipv6ip
```

Configuring GRE Tunnels: Examples

The following example configures a GRE tunnel running both IS-IS and IPv6 traffic between router A and router B:

Router A Configuration

```

ipv6 unicast-routing
clns routing
!
interface tunnel 0
no ip address
ipv6 address 2001:0DB8:1111:2222::1/64
ipv6 router isis
tunnel source Ethernet 0/0
tunnel destination 10.0.0.2
tunnel mode gre ipv6
!
interface Ethernet0/0
ip address 10.0.0.1 255.255.255.0
!
router isis
net 49.0000.0000.000a.00

```

Router B Configuration

```

ipv6 unicast-routing
clns routing
!
interface tunnel 0
no ip address
ipv6 address 2001:0DB8:1111:2222::2/64
ipv6 router isis
tunnel source Ethernet 0/0
tunnel destination 10.0.0.1
tunnel mode gre ipv6
!
interface Ethernet0/0
ip address 10.0.0.2 255.255.255.0
!
router isis
net 49.0000.0000.000b.00
address-family ipv6
redistribute static
exit-address-family

```

Tunnel Destination Address for IPv6 Tunnel Example

The following example shows how to configure the tunnel destination address for GRE tunneling of IPv6 packets:

```

Router(config)# interface Tunnel0
Router(config-if)# no ip address
Router(config-if)# ipv6 router isis
Router(config-if)# tunnel source Ethernet 0/0
Router(config-if)# tunnel destination 2001:0DB8:1111:2222::1/64
Router(config-if)# tunnel mode gre ipv6
Router(config-if)# exit
!
Router(config)# interface Ethernet0/0
Router(config-if)# ip address 10.0.0.1 255.255.255.0
Router(config-if)# exit

```



```
!  
Router(config)# ipv6 unicast-routing  
  
Router(config)# router isis  
Router(config)# net 49.0000.0000.000a.00
```

Configuring CTunnels in GRE mode to Carry IPv6 Packets in CLNS: Example

The following example configures a GRE CTunnel running both IS-IS and IPv6 traffic between router A and router B in a CLNS network. The **ctunnel mode gre** command allows tunneling between Cisco and third-party networking devices and carries both IPv4 and IPv6 traffic.

The **ctunnel mode gre** command provides a method of tunneling compliant with RFC 3147 and should allow tunneling between Cisco equipment and third-party networking devices.

Router A

```
ipv6 unicast-routing  
  
clns routing  
  
interface ctunnel 102  
  
  ipv6 address 2001:0DB8:1111:2222::1/64  
  ctunnel destination 49.0001.2222.2222.2222.00  
  ctunnel mode gre  
  
interface Ethernet0/1  
  clns router isis  
  
router isis  
  net 49.0001.1111.1111.1111.00
```

Router B

```
ipv6 unicast-routing  
  
clns routing  
  
interface ctunnel 201  
  ipv6 address 2001:0DB8:1111:2222::2/64  
  ctunnel destination 49.0001.1111.1111.1111.00  
  ctunnel mode gre  
  
interface Ethernet0/1  
  clns router isis  
  
router isis  
  net 49.0001.2222.2222.2222.00
```

To turn off the GRE mode and restore the CTunnel to the default Cisco encapsulation routing only between endpoints on Cisco equipment, use either the **no ctunnel mode** command or the **ctunnel mode cisco** command. The following example shows the same configuration modified to transport only IPv4 traffic.

Configuring 6to4 Tunnels Example

The following example configures a 6to4 tunnel on a border router in an isolated IPv6 network. The IPv4 address is 192.168.99.1, which translates to the IPv6 prefix of 2002:c0a8:6301::/48. The IPv6 prefix is subnetted into 2002:c0a8:6301::/64 for the tunnel interface: 2002:c0a8:6301:1::/64 for the first IPv6 network, and 2002:c0a8:6301:2::/64 for the second IPv6 network. The static route ensures that any other traffic for the IPv6 prefix 2002::/16 is directed to tunnel interface 0 for automatic tunneling.

```
interface Ethernet0
  description IPv4 uplink
  ip address 192.168.99.1 255.255.255.0
!
interface Ethernet1
  description IPv6 local network 1
  ipv6 address 2002:c0a8:6301:1::1/64
!
interface Ethernet2
  description IPv6 local network 2
  ipv6 address 2002:c0a8:6301:2::1/64
!
interface Tunnel0
  description IPv6 uplink
  no ip address
  ipv6 address 2002:c0a8:6301::1/64
  tunnel source Ethernet 0
  tunnel mode ipv6ip 6to4
!
ipv6 route 2002::/16 tunnel 0
```

Configuring IPv4-Compatible IPv6 Tunnels Example

The following example configures an IPv4-compatible IPv6 tunnel that allows Border Gateway Protocol (BGP) to run between a number of routers without having to configure a mesh of manual tunnels. Each router has a single IPv4-compatible tunnel, and multiple BGP sessions can run over each tunnel, one to each neighbor. Ethernet interface 0 is used as the tunnel source. The tunnel destination is automatically determined by the IPv4 address in the low-order 32 bits of an IPv4-compatible IPv6 address. Specifically, the IPv6 prefix 0:0:0:0:0 is concatenated to an IPv4 address (in the format 0:0:0:0:0:A.B.C.D or ::A.B.C.D) to create the IPv4-compatible IPv6 address. Ethernet interface 0 is configured with a global IPv6 address and an IPv4 address (the interface supports both the IPv6 and IPv4 protocol stacks).

Multiprotocol BGP is used in the example to exchange IPv6 reachability information with the peer 10.67.0.2. The IPv4 address of Ethernet interface 0 is used in the low-order 32 bits of an IPv4-compatible IPv6 address and is also used as the next-hop attribute. Using an IPv4-compatible IPv6 address for the BGP neighbor allows the IPv6 BGP session to be automatically transported over an IPv4-compatible tunnel.

```
interface tunnel 0
  tunnel source Ethernet 0
  tunnel mode ipv6ip auto-tunnel

interface ethernet 0
  ip address 10.27.0.1 255.255.255.0
  ipv6 address 3000:2222::1/64

router bgp 65000
  no synchronization
  no bgp default ipv4-unicast
```

```

neighbor ::10.67.0.2 remote-as 65002

address-family ipv6
neighbor ::10.67.0.2 activate
neighbor ::10.67.0.2 next-hop-self
network 2001:2222:d00d:b10b::/64

```

Configuring ISATAP Tunnels Example

The following example shows the tunnel source defined on Ethernet 0 and the **tunnel mode** command used to configure the ISATAP tunnel. Router advertisements are enabled to allow client autoconfiguration.

```

ipv6 unicast-routing
interface tunnel 1
 tunnel source ethernet 0
 tunnel mode ipv6ip isatap
 ipv6 address 2001:0DB8::/64 eui-64
 no ipv6 nd suppress-ra
 exit

```

Where to Go Next

- If you have configured an automatic 6to4 tunnel you can design your IPv6 network around the /48 6to4 prefix you have created from your IPv4 address.
- If you want to implement routing protocols, refer to the *Implementing RIP for IPv6*, *Implementing IS-IS for IPv6*, *Implementing OSPF for IPv6*, or *Implementing Multiprotocol BGP for IPv6* module.
- If you want to implement security features for your IPv6 network, refer to the *Implementing Security for IPv6* module.

Additional References

The following sections provide references related to implementing tunneling for IPv6.

Related Documents

Related Topic	Document Title
IPSec VTIs	<i>Implementing IPSec on IPv6</i>
IPv4 tunneling configuration tasks	“Configuring Logical Interfaces” chapter in the <i>Cisco IOS Interface Configuration Guide</i> , Release 12.4
IPv4 tunneling commands: complete command syntax, command mode, defaults, usage guidelines, and examples	<i>Cisco IOS Interface Command Reference</i> , Release 12.4
IPv6 supported feature list	<i>Start Here: Cisco IOS Software Release Specifics for IPv6 Features</i>

Related Topic	Document Title
IPv6 commands: complete command syntax, command mode, defaults, usage guidelines, and examples	<i>IPv6 for Cisco IOS Command Reference</i>
IPv4 configuration and command reference information	Cisco IOS Release 12.4 Configuration Guides and Command References

Standards

Standards	Title
No new or modified standards are supported by this feature, and support for existing standards has not been modified by this feature.	—

MIBs

MIBs	MIBs Link
No new or modified MIBs are supported by this feature, and support for existing MIBs has not been modified by this feature.	To locate and download MIBs for selected platforms, Cisco IOS releases, and feature sets, use Cisco MIB Locator found at the following URL: http://www.cisco.com/go/mibs

RFCs

RFCs	Title
RFC 2473	<i>Generic Packet Tunneling in IPv6 Specification</i>
RFC 2893	<i>Transition Mechanisms for IPv6 Hosts and Routers</i>
RFC 3056	<i>Connection of IPv6 Domains via IPv4 Clouds</i>
RFC 4214	<i>Intra-Site Automatic Tunnel Addressing Protocol (ISATAP)</i>

Technical Assistance

Description	Link
The Cisco Technical Support website contains thousands of pages of searchable technical content, including links to products, technologies, solutions, technical tips, and tools. Registered Cisco.com users can log in from this page to access even more content.	http://www.cisco.com/techsupport